

Relay 1	Lane 1	<h1>HAGLUND Wayne</h1>
-------------------	------------------	------------------------

2023 SFC Pistol Nationals AB	SP	MP
------------------------------	----	----

15.07.2023	PN23AP-Q-1	Alberta Handgun Association
------------	------------	-----------------------------

Comment	Signature
---------	-----------

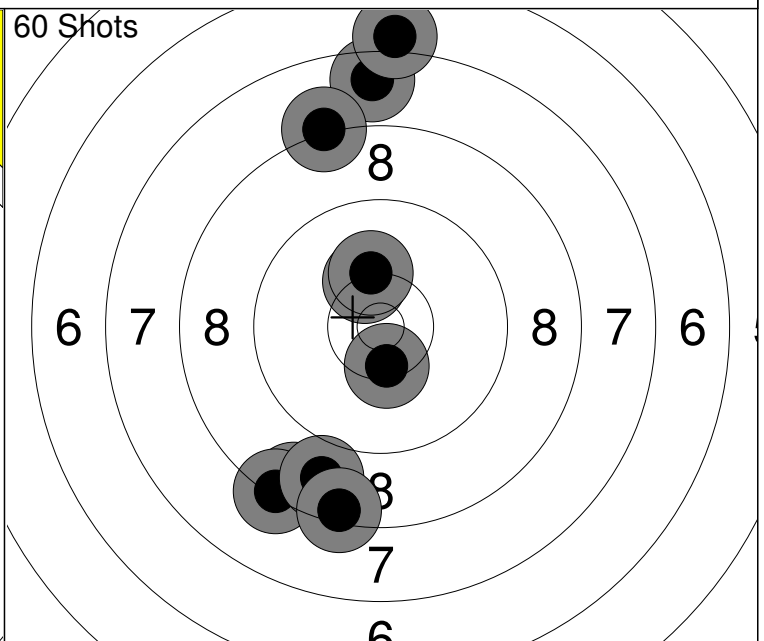
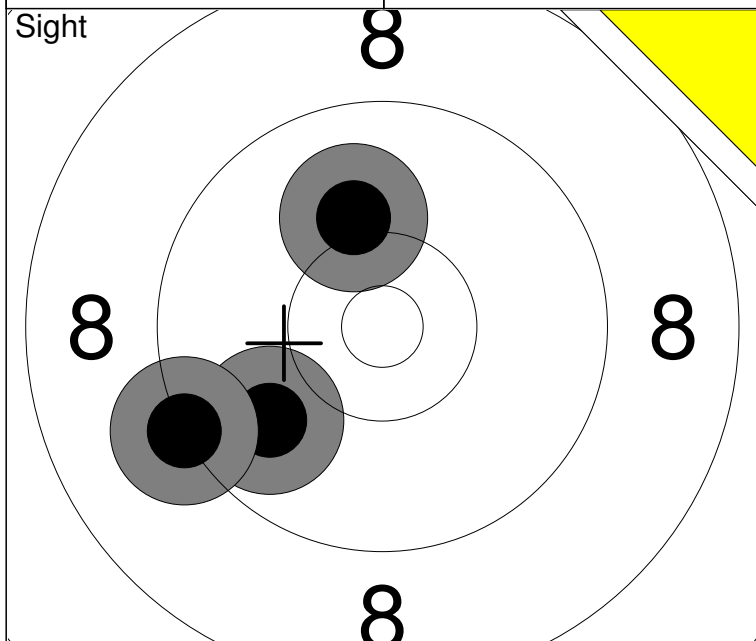

1: 9.8 ↙	Series	28 (0x)
2: 9.2 ↙		
3: 10.1 ↑		
		0 (0x)

1: 8.5 ↘	Series	84 (1x)
2: 8.3 ↘		
3: 8.8 ↘		
4: 7.6 ↑		
5: 10.3 ↑	84 (1x)	

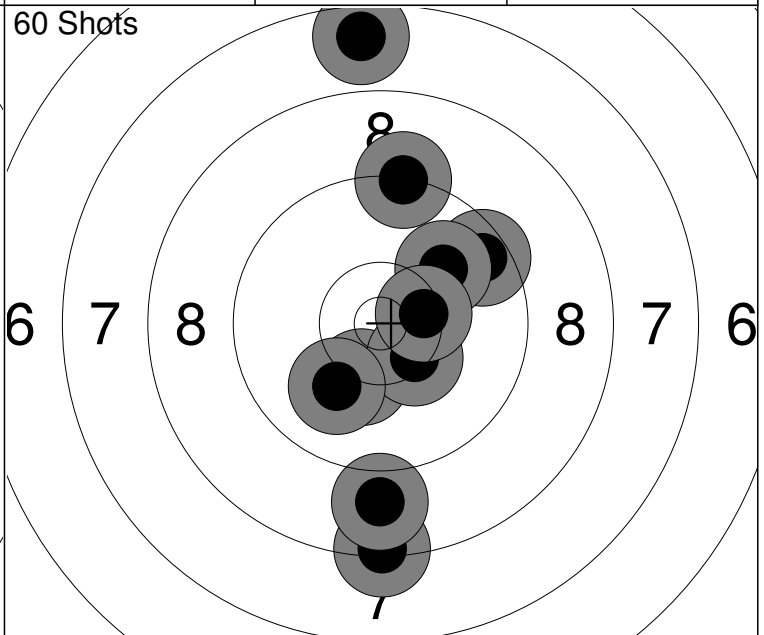
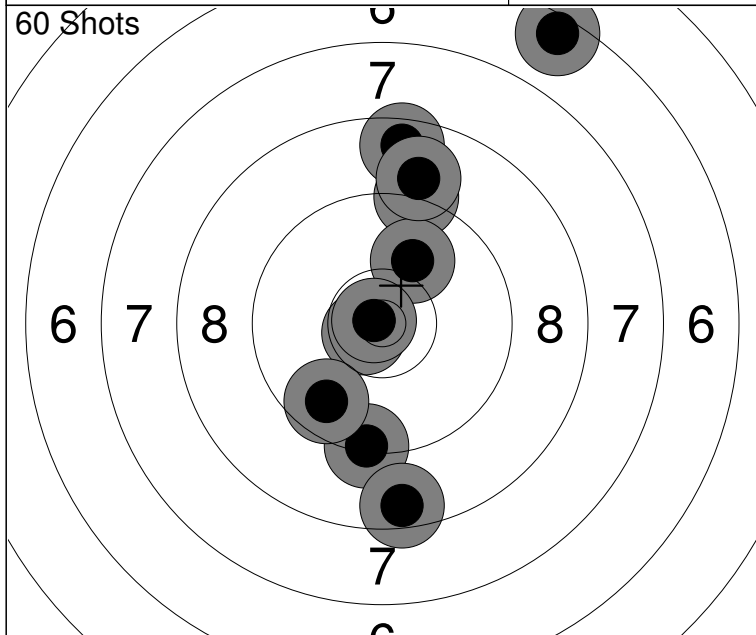

11: 9.2 ↑	Series	88 (2x)
12: 9.3 ↓		
13: 6.5 ↗		
14: 8.6 ↑		
15: 10.0 ↗	172 (3x)	

16: 9.0 ↑	Series	91 (2x)
17: 10.7x ↙		
18: 9.7 ↘		
19: 8.5 ↓		
20: 10.8x ↙	263 (5x)	

Relay 1	Lane 2	ZHOU Mo
-------------------	------------------	----------------

2023 SFC Pistol Nationals	BC	SJ	MP
---------------------------	----	----	----

15.07.2023	PN23AP-Q-1	Alberta Handgun Association
------------	------------	-----------------------------

Comment	Signature
---------	-----------

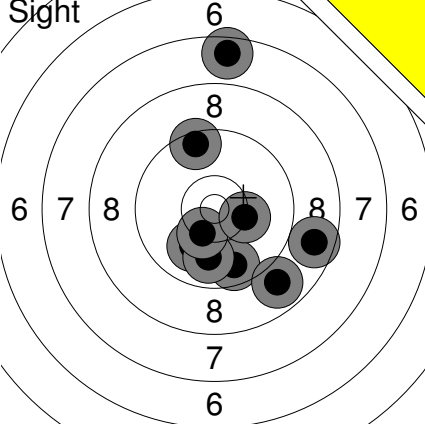
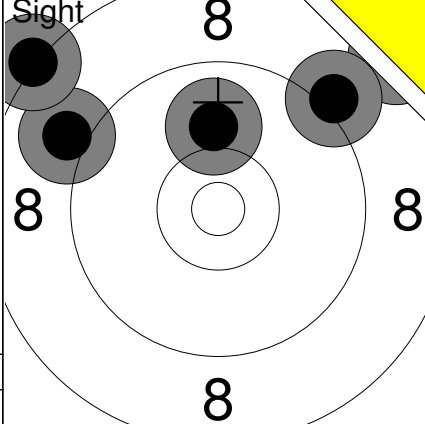
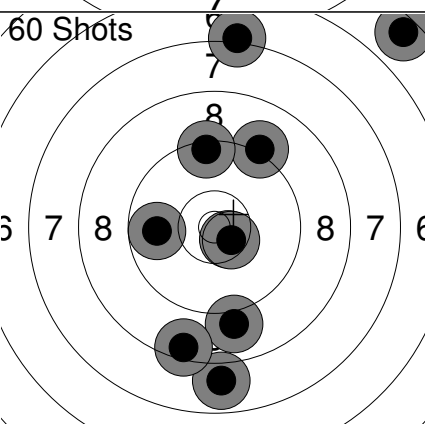
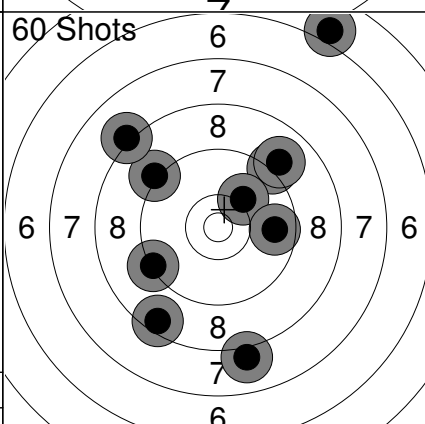
	<p>1: 10.0 ↘ 2: 7.6 ↑ 3: 9.7 ↓ 4: 9.9 ↓ 5: 10.4x ↓ 6: 8.7 → 7: 10.3 → 8: 9.5 ↑ 9: 8.9 ↓ 10: 5.6 ↗</p> <p>Series 85 (1x) 0 (0x)</p>		<p>11: 9.0 ↖ 12: 8.2 ↗ 13: 10.0 ↑ 14: 8.2 ↖ 15: 9.1 ↗</p> <p>Series 44 (0x) 0 (0x)</p>
	<p>21: 9.0 ↓ 22: 5.5 ↗ 23: 7.9 ↓ 24: 9.2 ↗ 25: 8.5 ↓ 26: 7.1 ↑ 27: 9.4 ↑ 28: 9.8 ← 29: 10.6x ↓ 30: 10.5x ↓</p> <p>Series 83 (2x) 259 (5x)</p>		<p>31: 9.2 ↗ 32: 9.0 ↗ 33: 6.0 ↗ 34: 10.1 ↗ 35: 9.7 → 36: 9.2 ↖ 37: 8.1 ↖ 38: 9.3 ← 39: 8.5 ↘ 40: 8.0 ↓</p> <p>Series 85 (0x) 344 (5x)</p>

Relay **1** Lane **3** **NORMAN Rex**

2023 SFC Pistol Nationals SK JR MP

15.07.2023 PN23AP-Q-1 Alberta Handgun Association

Comment Signature

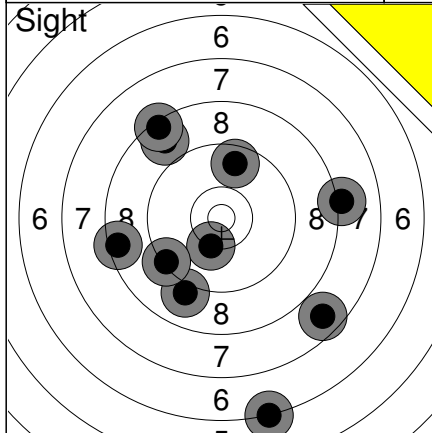

1:	8.7	↗
2:	10.2	↓
3:	9.0	↓
4:	8.5	←
5:	7.7	↓
6:	8.4	↗
7:	6.2	↓
8:	9.3	←
9:	9.6	↑
10:	8.1	→
Series	82 (0x)	
	0 (0x)	

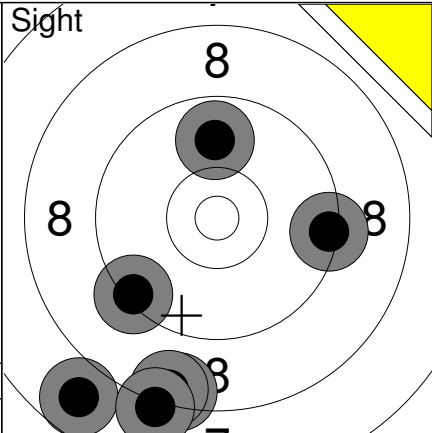

11:	8.4	↓
12:	7.8	↙
13:	9.4	→
14:	8.4	↓
15:	9.4	↙
16:	9.9	↑
17:	8.1	↓
Series	58 (0x)	
	0 (0x)	

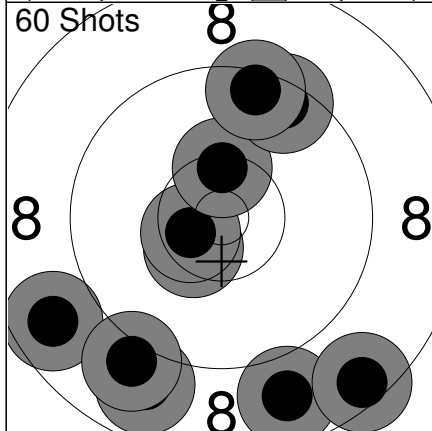

1:	8.8	↓
2:	10.5x	↙
3:	8.7	←
4:	10.6x	←
5:	8.9	↓
6:	9.0	↓
7:	10.4x	↑
8:	8.5	↓
9:	9.5	↗
10:	9.4	↑
Series	89 (3x)	
	89 (3x)	

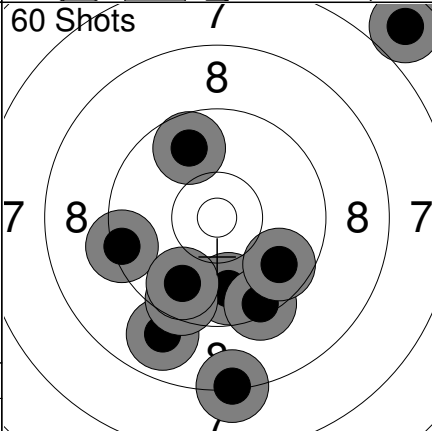

11:	9.8	↓
12:	8.9	↙
13:	9.4	↓
14:	8.3	↓
15:	6.7	↗
16:	9.8	↑
17:	9.5	↓
18:	9.4	←
19:	9.7	↘
20:	9.8	↓
Series	85 (0x)	
	174 (3x)	

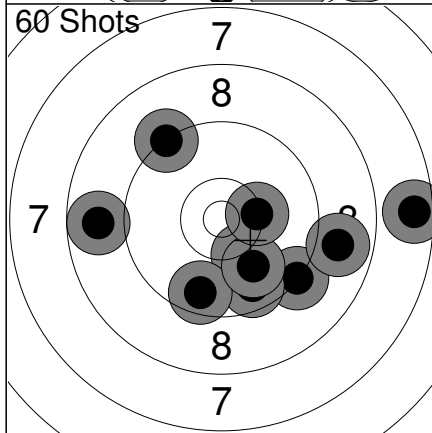

21:	10.2	↓
22:	8.8	←
23:	9.3	↘
24:	9.3	↗
25:	9.7	↓
26:	9.6	↙
27:	10.0	↓
28:	8.9	→
29:	7.6	→
30:	10.3	→
Series	89 (0x)	
	263 (3x)	

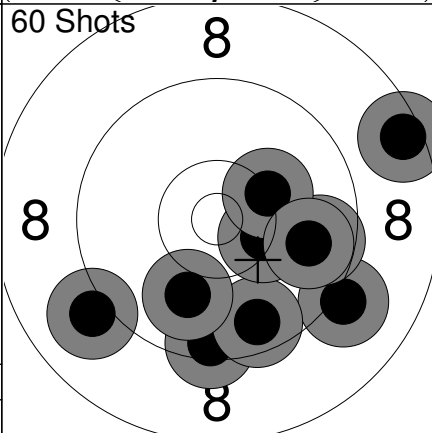

31:	9.1	↘
32:	9.4	↓
33:	9.6	↓
34:	8.5	→
35:	9.7	→
36:	10.3	→
37:	10.3	→
38:	9.0	←
39:	9.8	→
40:	10.0	↓
Series	92 (0x)	
	355 (3x)	

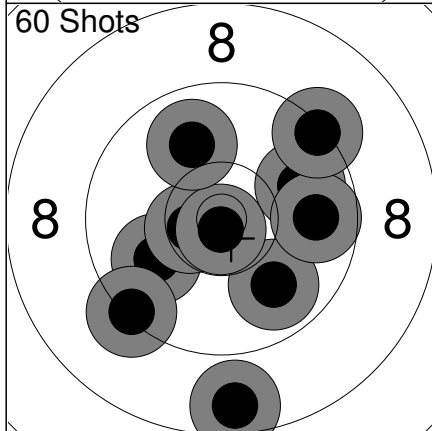

41:	8.6	↓
42:	10.0	←
43:	9.9	↓
44:	10.5x	←
45:	10.8x	↓
46:	9.3	↙
47:	9.9	→
48:	9.8	→
49:	9.9	↑
50:	9.3	↗
Series	92 (2x)	
	447 (5x)	

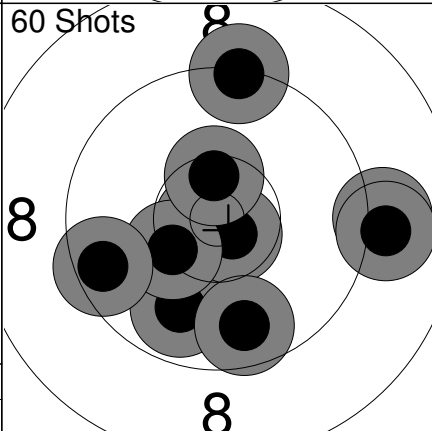

51:	9.9	↓
52:	10.8x	←
53:	10.7x	↘
54:	9.1	→
55:	10.3	↙
56:	9.7	↓
57:	9.3	↑
58:	9.0	→
59:	10.5x	↑
60:	9.5	←
Series	94 (3x)	
	541 (8x)	

Relay 1	Lane 4	NADON William
--------------------------	-------------------------	----------------------

2023 SFC Pistol Nationals	QC	JR	MP
---------------------------	----	----	----

15.07.2023	PN23AP-Q-1	Alberta Handgun Association
------------	------------	-----------------------------

Comment	Signature
---------	-----------

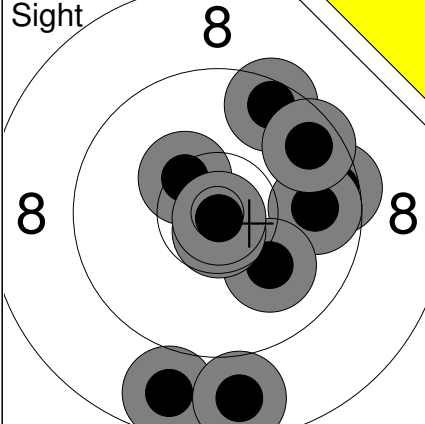
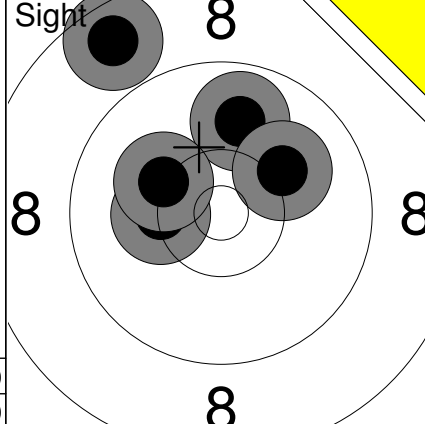
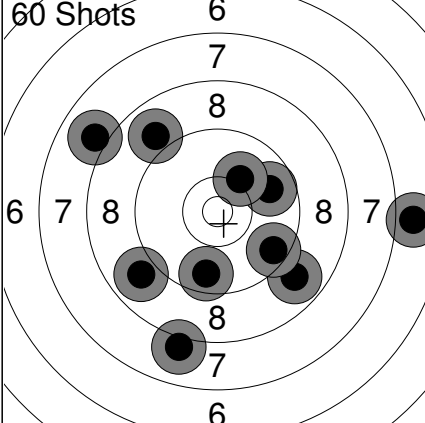
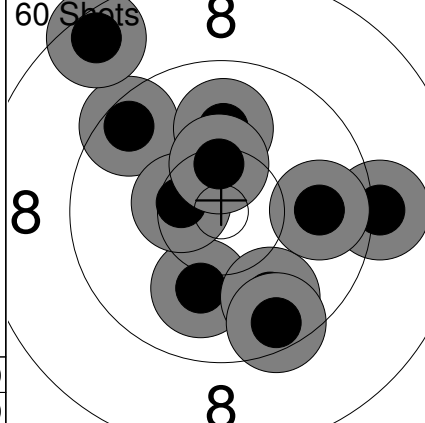
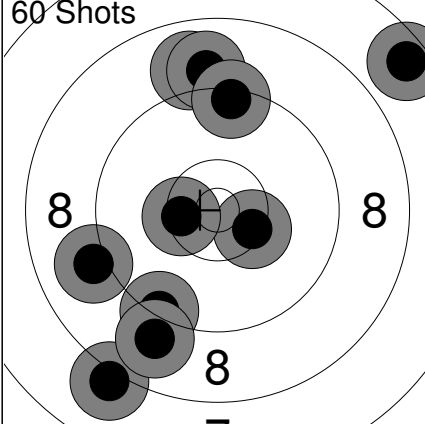
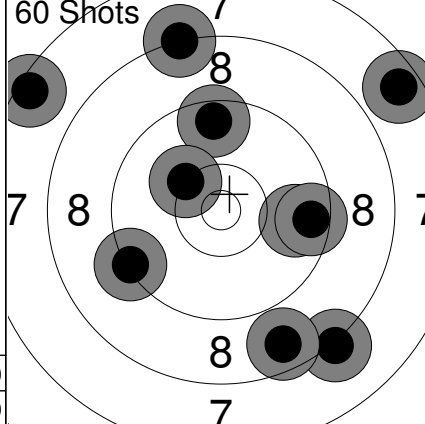
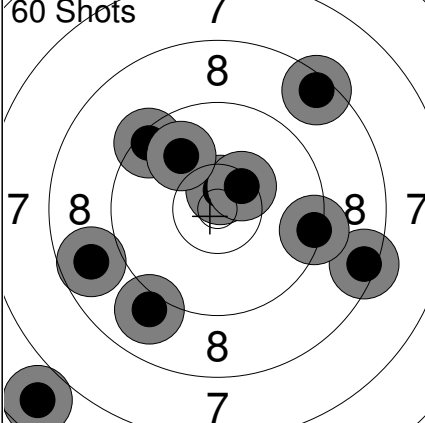
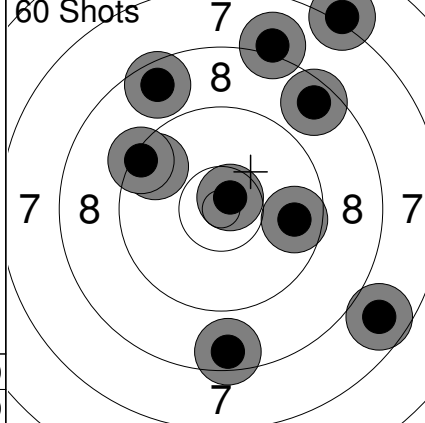
<p>Sight</p> 	<table border="1" style="width:100%; border-collapse: collapse;"> <tr><td>1:</td><td>9.5</td><td>↗</td></tr> <tr><td>2:</td><td>10.4x</td><td>↗</td></tr> <tr><td>3:</td><td>9.5</td><td>→</td></tr> <tr><td>4:</td><td>9.8</td><td>→</td></tr> <tr><td>5:</td><td>9.6</td><td>↗</td></tr> <tr><td>6:</td><td>10.1</td><td>↘</td></tr> <tr><td>7:</td><td>8.7</td><td>↘</td></tr> <tr><td>8:</td><td>10.7x</td><td>↘</td></tr> <tr><td>9:</td><td>8.7</td><td>↘</td></tr> <tr><td>10:</td><td>10.9x</td><td>↘</td></tr> <tr><td colspan="2">Series</td><td>92 (3x)</td></tr> <tr><td colspan="2"></td><td>0 (0x)</td></tr> </table>	1:	9.5	↗	2:	10.4x	↗	3:	9.5	→	4:	9.8	→	5:	9.6	↗	6:	10.1	↘	7:	8.7	↘	8:	10.7x	↘	9:	8.7	↘	10:	10.9x	↘	Series		92 (3x)			0 (0x)	<p>Sight</p> 	<table border="1" style="width:100%; border-collapse: collapse;"> <tr><td>11:</td><td>9.9</td><td>↗</td></tr> <tr><td>12:</td><td>10.3</td><td>←</td></tr> <tr><td>13:</td><td>10.2</td><td>↖</td></tr> <tr><td>14:</td><td>8.6</td><td>↗</td></tr> <tr><td>15:</td><td>10.1</td><td>↗</td></tr> <tr><td colspan="2">Series</td><td>47 (0x)</td></tr> <tr><td colspan="2"></td><td>0 (0x)</td></tr> </table>	11:	9.9	↗	12:	10.3	←	13:	10.2	↖	14:	8.6	↗	15:	10.1	↗	Series		47 (0x)			0 (0x)															
1:	9.5	↗																																																																									
2:	10.4x	↗																																																																									
3:	9.5	→																																																																									
4:	9.8	→																																																																									
5:	9.6	↗																																																																									
6:	10.1	↘																																																																									
7:	8.7	↘																																																																									
8:	10.7x	↘																																																																									
9:	8.7	↘																																																																									
10:	10.9x	↘																																																																									
Series		92 (3x)																																																																									
		0 (0x)																																																																									
11:	9.9	↗																																																																									
12:	10.3	←																																																																									
13:	10.2	↖																																																																									
14:	8.6	↗																																																																									
15:	10.1	↗																																																																									
Series		47 (0x)																																																																									
		0 (0x)																																																																									
<p>60 Shots</p> 	<table border="1" style="width:100%; border-collapse: collapse;"> <tr><td>1:</td><td>9.8</td><td>→</td></tr> <tr><td>2:</td><td>8.0</td><td>↗</td></tr> <tr><td>3:</td><td>8.9</td><td>↖</td></tr> <tr><td>4:</td><td>6.9</td><td>→</td></tr> <tr><td>5:</td><td>9.6</td><td>↘</td></tr> <tr><td>6:</td><td>8.9</td><td>↘</td></tr> <tr><td>7:</td><td>8.9</td><td>↗</td></tr> <tr><td>8:</td><td>10.1</td><td>↗</td></tr> <tr><td>9:</td><td>8.0</td><td>↘</td></tr> <tr><td>10:</td><td>9.5</td><td>↘</td></tr> <tr><td colspan="2">Series</td><td>83 (0x)</td></tr> <tr><td colspan="2"></td><td>83 (0x)</td></tr> </table>	1:	9.8	→	2:	8.0	↗	3:	8.9	↖	4:	6.9	→	5:	9.6	↘	6:	8.9	↘	7:	8.9	↗	8:	10.1	↗	9:	8.0	↘	10:	9.5	↘	Series		83 (0x)			83 (0x)	<p>60 Shots</p> 	<table border="1" style="width:100%; border-collapse: collapse;"> <tr><td>11:</td><td>9.1</td><td>→</td></tr> <tr><td>12:</td><td>10.1</td><td>↘</td></tr> <tr><td>13:</td><td>9.5</td><td>↗</td></tr> <tr><td>14:</td><td>10.5x</td><td>←</td></tr> <tr><td>15:</td><td>9.8</td><td>↘</td></tr> <tr><td>16:</td><td>9.5</td><td>↘</td></tr> <tr><td>17:</td><td>10.0</td><td>↑</td></tr> <tr><td>18:</td><td>8.5</td><td>↗</td></tr> <tr><td>19:</td><td>9.8</td><td>→</td></tr> <tr><td>20:</td><td>10.4x</td><td>↑</td></tr> <tr><td colspan="2">Series</td><td>93 (2x)</td></tr> <tr><td colspan="2"></td><td>176 (2x)</td></tr> </table>	11:	9.1	→	12:	10.1	↘	13:	9.5	↗	14:	10.5x	←	15:	9.8	↘	16:	9.5	↘	17:	10.0	↑	18:	8.5	↗	19:	9.8	→	20:	10.4x	↑	Series		93 (2x)			176 (2x)
1:	9.8	→																																																																									
2:	8.0	↗																																																																									
3:	8.9	↖																																																																									
4:	6.9	→																																																																									
5:	9.6	↘																																																																									
6:	8.9	↘																																																																									
7:	8.9	↗																																																																									
8:	10.1	↗																																																																									
9:	8.0	↘																																																																									
10:	9.5	↘																																																																									
Series		83 (0x)																																																																									
		83 (0x)																																																																									
11:	9.1	→																																																																									
12:	10.1	↘																																																																									
13:	9.5	↗																																																																									
14:	10.5x	←																																																																									
15:	9.8	↘																																																																									
16:	9.5	↘																																																																									
17:	10.0	↑																																																																									
18:	8.5	↗																																																																									
19:	9.8	→																																																																									
20:	10.4x	↑																																																																									
Series		93 (2x)																																																																									
		176 (2x)																																																																									
<p>60 Shots</p> 	<table border="1" style="width:100%; border-collapse: collapse;"> <tr><td>21:</td><td>8.9</td><td>↑</td></tr> <tr><td>22:</td><td>9.0</td><td>←</td></tr> <tr><td>23:</td><td>7.5</td><td>↗</td></tr> <tr><td>24:</td><td>9.0</td><td>↑</td></tr> <tr><td>25:</td><td>9.4</td><td>↑</td></tr> <tr><td>26:</td><td>10.4x</td><td>→</td></tr> <tr><td>27:</td><td>8.1</td><td>↘</td></tr> <tr><td>28:</td><td>9.3</td><td>↘</td></tr> <tr><td>29:</td><td>8.9</td><td>↘</td></tr> <tr><td>30:</td><td>10.4x</td><td>←</td></tr> <tr><td colspan="2">Series</td><td>87 (2x)</td></tr> <tr><td colspan="2"></td><td>263 (4x)</td></tr> </table>	21:	8.9	↑	22:	9.0	←	23:	7.5	↗	24:	9.0	↑	25:	9.4	↑	26:	10.4x	→	27:	8.1	↘	28:	9.3	↘	29:	8.9	↘	30:	10.4x	←	Series		87 (2x)			263 (4x)	<p>60 Shots</p> 	<table border="1" style="width:100%; border-collapse: collapse;"> <tr><td>31:</td><td>9.6</td><td>↑</td></tr> <tr><td>32:</td><td>8.2</td><td>↘</td></tr> <tr><td>33:</td><td>9.8</td><td>→</td></tr> <tr><td>34:</td><td>8.6</td><td>↘</td></tr> <tr><td>35:</td><td>9.5</td><td>→</td></tr> <tr><td>36:</td><td>8.2</td><td>↑</td></tr> <tr><td>37:</td><td>7.6</td><td>↗</td></tr> <tr><td>38:</td><td>10.2</td><td>↗</td></tr> <tr><td>39:</td><td>7.4</td><td>↖</td></tr> <tr><td>40:</td><td>9.3</td><td>↖</td></tr> <tr><td colspan="2">Series</td><td>84 (0x)</td></tr> <tr><td colspan="2"></td><td>347 (4x)</td></tr> </table>	31:	9.6	↑	32:	8.2	↘	33:	9.8	→	34:	8.6	↘	35:	9.5	→	36:	8.2	↑	37:	7.6	↗	38:	10.2	↗	39:	7.4	↖	40:	9.3	↖	Series		84 (0x)			347 (4x)
21:	8.9	↑																																																																									
22:	9.0	←																																																																									
23:	7.5	↗																																																																									
24:	9.0	↑																																																																									
25:	9.4	↑																																																																									
26:	10.4x	→																																																																									
27:	8.1	↘																																																																									
28:	9.3	↘																																																																									
29:	8.9	↘																																																																									
30:	10.4x	←																																																																									
Series		87 (2x)																																																																									
		263 (4x)																																																																									
31:	9.6	↑																																																																									
32:	8.2	↘																																																																									
33:	9.8	→																																																																									
34:	8.6	↘																																																																									
35:	9.5	→																																																																									
36:	8.2	↑																																																																									
37:	7.6	↗																																																																									
38:	10.2	↗																																																																									
39:	7.4	↖																																																																									
40:	9.3	↖																																																																									
Series		84 (0x)																																																																									
		347 (4x)																																																																									
<p>60 Shots</p> 	<table border="1" style="width:100%; border-collapse: collapse;"> <tr><td>41:</td><td>10.6x</td><td>↑</td></tr> <tr><td>42:</td><td>8.5</td><td>↗</td></tr> <tr><td>43:</td><td>8.4</td><td>→</td></tr> <tr><td>44:</td><td>10.4x</td><td>↗</td></tr> <tr><td>45:</td><td>6.7</td><td>↖</td></tr> <tr><td>46:</td><td>9.0</td><td>↘</td></tr> <tr><td>47:</td><td>9.4</td><td>↗</td></tr> <tr><td>48:</td><td>9.4</td><td>→</td></tr> <tr><td>49:</td><td>9.9</td><td>↗</td></tr> <tr><td>50:</td><td>8.7</td><td>←</td></tr> <tr><td colspan="2">Series</td><td>86 (2x)</td></tr> <tr><td colspan="2"></td><td>433 (6x)</td></tr> </table>	41:	10.6x	↑	42:	8.5	↗	43:	8.4	→	44:	10.4x	↗	45:	6.7	↖	46:	9.0	↘	47:	9.4	↗	48:	9.4	→	49:	9.9	↗	50:	8.7	←	Series		86 (2x)			433 (6x)	<p>60 Shots</p> 	<table border="1" style="width:100%; border-collapse: collapse;"> <tr><td>51:</td><td>8.6</td><td>↗</td></tr> <tr><td>52:</td><td>9.6</td><td>↖</td></tr> <tr><td>53:</td><td>9.7</td><td>→</td></tr> <tr><td>54:</td><td>9.4</td><td>↖</td></tr> <tr><td>55:</td><td>8.6</td><td>↗</td></tr> <tr><td>56:</td><td>8.1</td><td>↑</td></tr> <tr><td>57:</td><td>7.1</td><td>↗</td></tr> <tr><td>58:</td><td>8.5</td><td>↘</td></tr> <tr><td>59:</td><td>7.7</td><td>↘</td></tr> <tr><td>60:</td><td>10.7x</td><td>↗</td></tr> <tr><td colspan="2">Series</td><td>83 (1x)</td></tr> <tr><td colspan="2"></td><td>516 (7x)</td></tr> </table>	51:	8.6	↗	52:	9.6	↖	53:	9.7	→	54:	9.4	↖	55:	8.6	↗	56:	8.1	↑	57:	7.1	↗	58:	8.5	↘	59:	7.7	↘	60:	10.7x	↗	Series		83 (1x)			516 (7x)
41:	10.6x	↑																																																																									
42:	8.5	↗																																																																									
43:	8.4	→																																																																									
44:	10.4x	↗																																																																									
45:	6.7	↖																																																																									
46:	9.0	↘																																																																									
47:	9.4	↗																																																																									
48:	9.4	→																																																																									
49:	9.9	↗																																																																									
50:	8.7	←																																																																									
Series		86 (2x)																																																																									
		433 (6x)																																																																									
51:	8.6	↗																																																																									
52:	9.6	↖																																																																									
53:	9.7	→																																																																									
54:	9.4	↖																																																																									
55:	8.6	↗																																																																									
56:	8.1	↑																																																																									
57:	7.1	↗																																																																									
58:	8.5	↘																																																																									
59:	7.7	↘																																																																									
60:	10.7x	↗																																																																									
Series		83 (1x)																																																																									
		516 (7x)																																																																									

Relay **1** Lane **5** **WANG Hejia**

2023 SFC Pistol Nationals BC JR MP

15.07.2023 PN23AP-Q-1 Alberta Handgun Association

Comment Signature

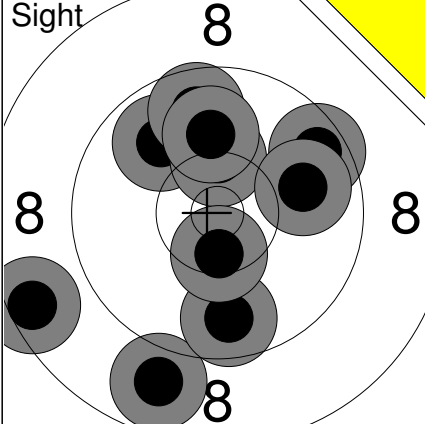
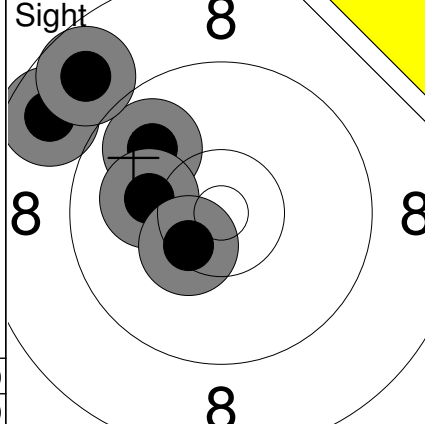
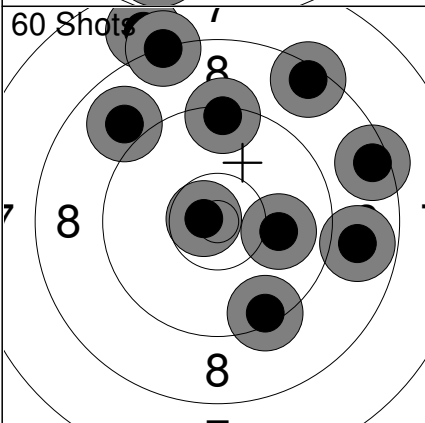
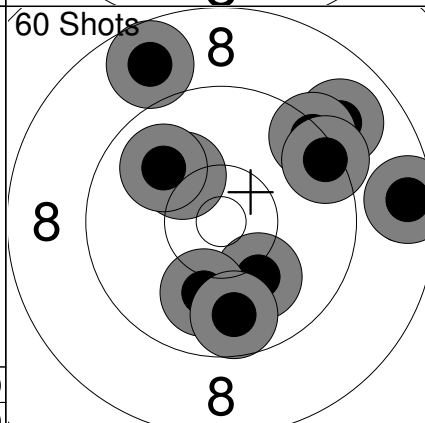
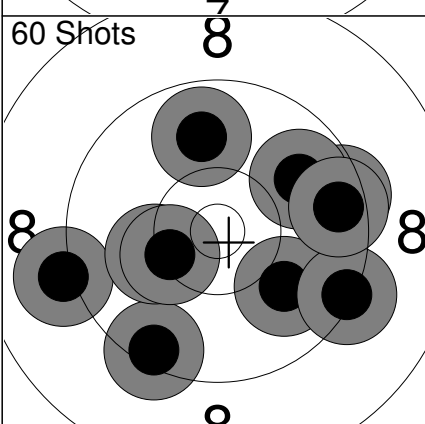
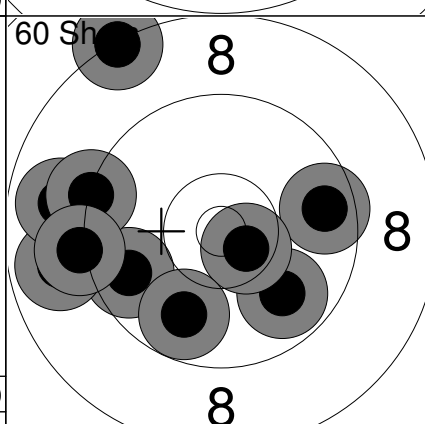
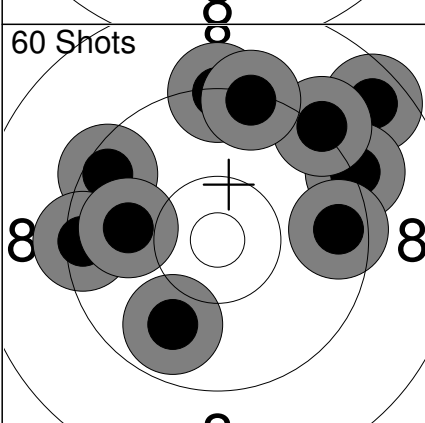
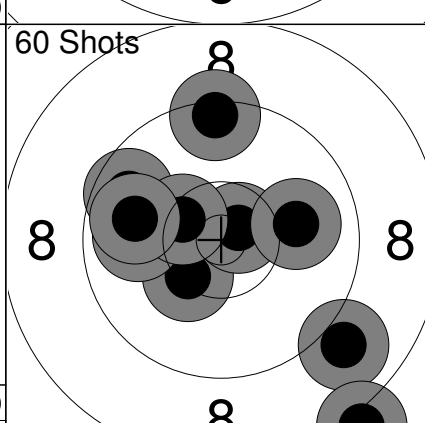
Sight		1: 8.8 ↓	Sight		11: 9.9 ↗
		2: 9.9 ↗			12: 10.1 ←
		3: 8.5 ←			13: 8.7 ↗
		4: 9.7 ↓			14: 8.8 ↗
		5: 9.7 ↑			15: 10.4x ↓
		6: 10.3 ↑			
		7: 10.0 ↑			
		8: 9.6 →			
		9: 9.9 →			
		10: 10.5x ↓			
		Series 91 (1x)			Series 45 (1x)
		0 (0x)			0 (0x)
60 Shots		1: 9.4 ↓	60 Shots		11: 9.0 ↗
		2: 10.0 →			12: 8.8 ↗
		3: 8.8 →			13: 8.6 →
		4: 9.4 ↑			14: 10.1 ↓
		5: 7.9 ↑			15: 10.0 ↓
		6: 10.7x ←			16: 10.2 ↗
		7: 8.2 ↑			17: 9.8 ↓
		8: 8.9 ↗			18: 9.4 ↗
		9: 8.5 →			19: 9.9 ↗
		10: 8.4 ↗			20: 9.4 ↗
		Series 85 (1x)			Series 91 (0x)
		85 (1x)			176 (1x)
60 Shots		21: 10.0 ↓	60 Shots		31: 9.7 ←
		22: 9.4 ↓			32: 9.6 →
		23: 9.5 →			33: 8.9 ←
		24: 9.9 ↑			34: 9.9 ↓
		25: 9.8 →			35: 10.6x ↓
		26: 9.1 ←			36: 9.8 ↓
		27: 9.3 →			37: 8.9 ←
		28: 10.2 ←			38: 9.3 ←
		29: 9.5 →			39: 8.3 ↗
		30: 10.3 ←			40: 9.2 ←
		Series 93 (0x)			Series 88 (1x)
		269 (1x)			357 (2x)
60 Shots		41: 9.5 ←	60 Shots		51: 10.3 ↓
		42: 9.4 ←			52: 9.4 ↑
		43: 8.6 ↗			53: 8.9 ↓
		44: 9.2 →			54: 9.9 ←
		45: 9.9 ←			55: 10.7x ↗
		46: 9.9 ↓			56: 9.7 ↗
		47: 9.6 →			57: 8.1 ↓
		48: 9.2 ↗			58: 10.4x ↗
		49: 9.3 ↑			59: 10.0 →
		50: 9.3 ↑			60: 9.8 ←
		Series 89 (0x)			Series 92 (2x)
		446 (2x)			538 (4x)

Relay **1** Lane **6** **NORMAN Seth**

2023 SFC Pistol Nationals SK IJ MP

15.07.2023 PN23AP-Q-1 Alberta Handgun Association

Comment Signature

	1: 9.0 ↑ 2: 8.1 ← 3: 9.9 ↑ 4: 10.0 ← 5: 9.2 ↓ 6: 9.8 ↑		1: 10.1 ↑ 2: 10.5x ↗ 3: 9.5 → 4: 10.5x ← 5: 8.4 ↗ 6: 9.4 ↘ 7: 9.3 ↓ 8: 9.7 ↓ 9: 9.2 → 10: 9.2 ↓
	Series 54 (0x) 0 (0x)		Series 92 (2x) 92 (2x)

	11: 9.6 → 12: 8.6 ↓ 13: 10.2 ↓ 14: 8.6 → 15: 9.4 ↓ 16: 9.6 → 17: 9.3 ↓ 18: 10.4x → 19: 8.1 ↓ 20: 9.4 ↓		21: 9.4 ↘ 22: 10.1 → 23: 8.3 ↗ 24: 10.0 ↘ 25: 9.9 ↓ 26: 9.7 ↓ 27: 9.9 ← 28: 9.9 ↘ 29: 9.2 ↘ 30: 7.7 →
	Series 89 (1x) 181 (3x)		Series 89 (0x) 270 (3x)

	31: 5.5 ↑ 32: 10.4x ↓ 33: 9.6 ↓ 34: 10.5x ↗ 35: 10.0 ↓ 36: 8.5 ↗ 37: 10.5x ↘ 38: 9.9 ↓ 39: 10.2 ↓ 40: 10.5x →		41: 10.5x ↗ 42: 9.6 ↗ 43: 10.0 ↓ 44: 10.2 ↓ 45: 10.2 ↓ 46: 8.8 ↓ 47: 9.2 ↓ 48: 9.8 ← 49: 10.4x ↓ 50: 10.0 ↓
	Series 91 (4x) 361 (7x)		Series 95 (2x) 456 (9x)

	51: 8.6 ↓ 52: 9.3 ↓ 53: 9.8 → 54: 10.4x ↓ 55: 9.7 ↘ 56: 9.9 ← 57: 9.3 ↘ 58: 8.7 ↓ 59: 10.0 ↓ 60: 10.5x ↓	
	Series 91 (2x) 547 (11x)	

Relay **1** Lane **7** **TESSIER Jacques**

2023 SFC Pistol Nationals QC VT MP

15.07.2023 PN23AP-Q-1 Alberta Handgun Association

Comment Signature

	1: 5.7 ←		1: 9.5 ↙
	2: 7.1 ↗		2: 9.1 →
	3: 7.9 ↓		3: 10.2 ↓
	4: 7.4 →		4: 9.6 ↘
	5: 10.1 ↑		5: 7.9 ↓
	6: 7.9 →		6: 9.0 ↓
	7: 9.6 ↓		7: 7.1 ↖
	8: 7.6 →		8: 9.4 ↘
	9: 7.8 →		9: 10.1 ↙
	10: 8.5 ↓		10: 9.4 ↗
Series	74 (0x)	Series	88 (0x)
	0 (0x)		88 (0x)

	11: 9.2 ←		21: 7.7 ↙
	12: 9.6 ←		22: 8.8 ↓
	13: 8.9 ↓		23: 9.8 →
	14: 8.5 ←		24: 10.2 ↑
	15: 8.9 ←		25: 10.3 ↓
	16: 9.1 ↓		26: 9.9 ↖
	17: 8.3 ↓		27: 8.0 ↓
	18: 9.2 ←		28: 5.7 ↗
	19: 7.4 ↓		29: 6.9 ↘
	20: 9.5 ↗		30: 9.7 ↗
Series	84 (0x)	Series	81 (0x)
	172 (0x)		253 (0x)

	31: 10.7x →		41: 8.7 ↙
	32: 9.9 ↖		42: 9.4 ↓
	33: 9.3 →		43: 9.8 ↓
	34: 9.5 ←		44: 9.5 ←
	35: 8.3 ↓		45: 10.2 ↓
	36: 7.5 ↓		46: 7.6 ↓
	37: 10.2 ↓		47: 10.2 ↓
	38: 8.5 ←		48: 9.8 ↗
	39: 8.5 ↑		49: 9.0 →
	40: 9.0 ↑		50: 7.6 →
Series	87 (1x)	Series	87 (0x)
	340 (1x)		427 (1x)

	51: 9.8 ↓		
	52: 9.4 →		
	53: 10.9x ←		
	54: 8.9 ↑		
	55: 10.4x ↖		
	56: 9.1 ←		
	57: 7.6 ↓		
	58: 8.3 ←		
	59: 10.2 →		
	60: 8.9 ↓		
Series	88 (2x)		
	515 (3x)		

Relay **1** Lane **8** **POLAD HOSHERDAR**

2023 SFC Pistol Nationals NS VT MP

15.07.2023 PN23AP-Q-1 Alberta Handgun Association

Comment Signature

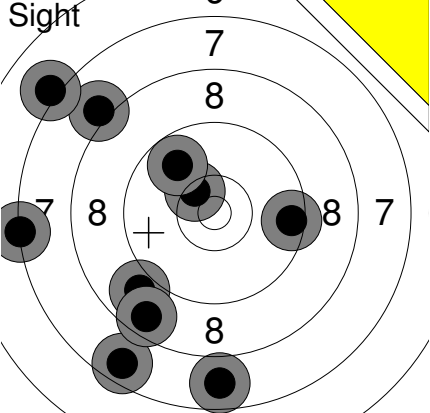
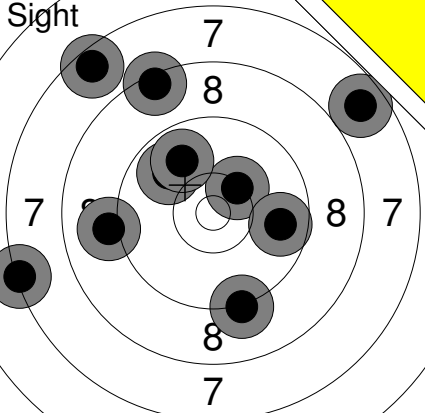
Sight 	1: 10.4x ↗	Sight 	11: 9.2 ↓
	2: 7.6 ↘		12: 10.3 ↗
	3: 8.9 ↖		13: 9.1 ←
	4: 7.3 ←		14: 9.7 →
	5: 8.6 ↘		15: 7.3 ←
	6: 8.0 ↗		16: 9.9 ↗
	7: 7.1 ↗		17: 7.5 ↗
	8: 7.7 ↘		18: 9.9 ↗
	9: 9.8 ↗		19: 7.7 ↗
	10: 9.5 →		20: 8.4 ↗
Series	80 (1x)	Series	84 (0x)
	0 (0x)		0 (0x)

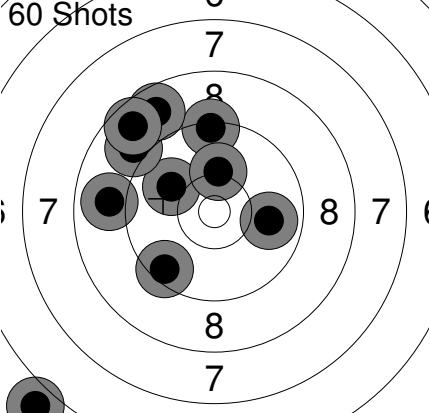
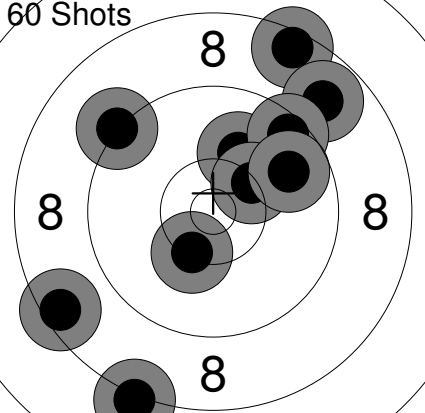
60 Shots 	1: 10.0 ↗	60 Shots 	11: 10.3 ↓
	2: 5.8 ↘		12: 8.5 ←
	3: 9.3 ↑		13: 8.2 ↓
	4: 9.9 →		14: 8.5 ↗
	5: 9.5 ↘		15: 10.1 ↗
	6: 8.9 ←		16: 9.2 ↖
	7: 9.0 ↗		17: 8.8 ↗
	8: 10.2 ↑		18: 9.5 ↗
	9: 8.7 ↗		19: 10.3 ↗
	10: 8.7 ↗		20: 9.8 ↗
Series	85 (0x)	Series	89 (0x)
	85 (0x)		174 (0x)

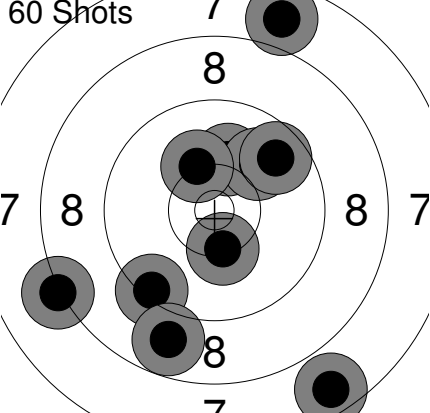
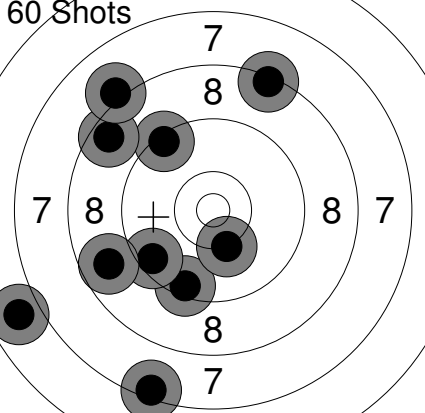
60 Shots 	21: 10.1 ↑	60 Shots 	31: 9.4 ↓
	22: 9.4 ↘		32: 7.4 ↓
	23: 7.8 ↑		33: 8.3 ↗
	24: 8.2 ←		34: 9.4 ↗
	25: 8.8 ↘		35: 8.6 ↖
	26: 10.3 ↘		36: 10.2 ↓
	27: 10.0 ↗		37: 9.5 ←
	28: 7.6 ↘		38: 8.8 ←
	29: 9.7 ↗		39: 8.1 ↗
	30: 10.2 ↑		40: 6.8 ←
Series	88 (0x)	Series	82 (0x)
	262 (0x)		344 (0x)

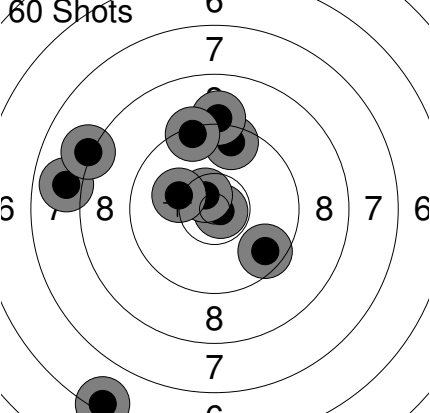
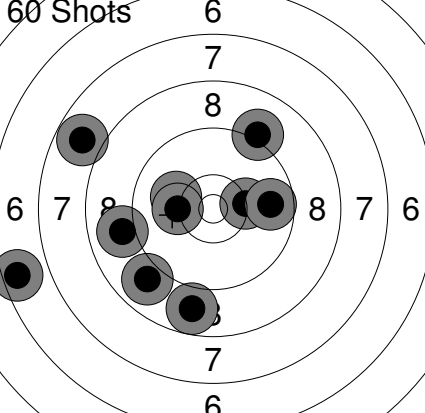
60 Shots 	41: 9.6 ↑	60 Shots 	51: 9.1 ↗
	42: 9.1 ↑		52: 8.8 ↓
	43: 6.4 ↘		53: 10.2 →
	44: 10.8x →		54: 7.8 ←
	45: 9.6 ↘		55: 8.9 ↘
	46: 9.4 ↗		56: 9.7 →
	47: 10.6x ↗		57: 6.5 ←
	48: 7.9 ←		58: 10.1 ←
	49: 10.2 ↗		59: 9.0 ←
	50: 8.2 ↖		60: 10.2 ←
Series	87 (2x)	Series	86 (0x)
	431 (2x)		517 (2x)

Relay 1	Lane 9	<h1>KINDBOM Matt</h1>
-------------------	------------------	-----------------------

2023 SFC Pistol Nationals	ON	SS	MP
---------------------------	----	----	----

15.07.2023	PN23AP-Q-1	Alberta Handgun Association
------------	------------	-----------------------------

Comment	Signature
---------	-----------

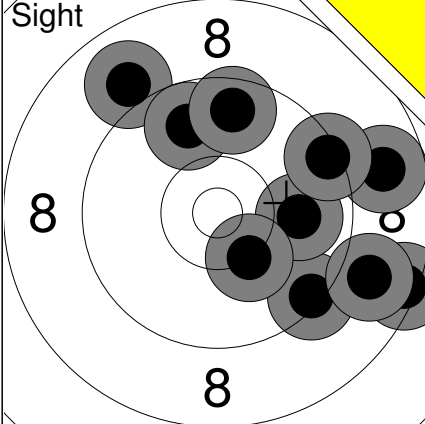
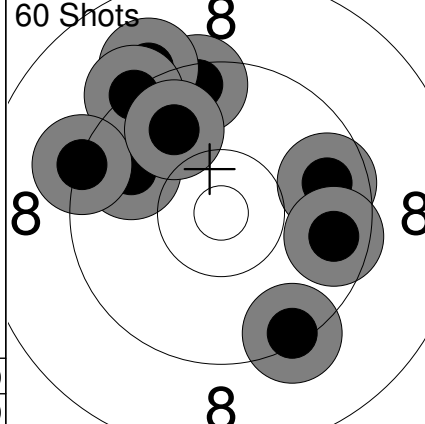
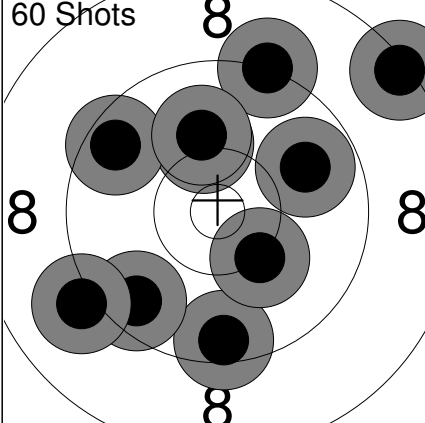
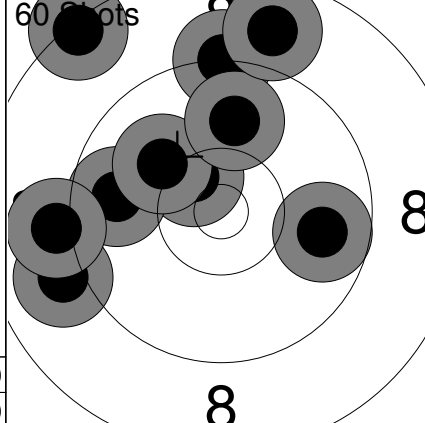
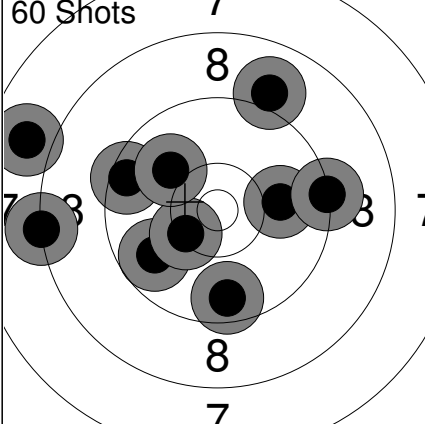
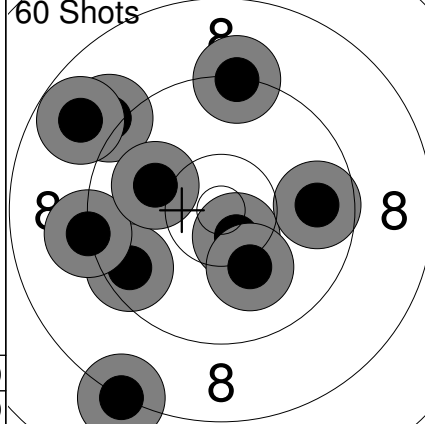
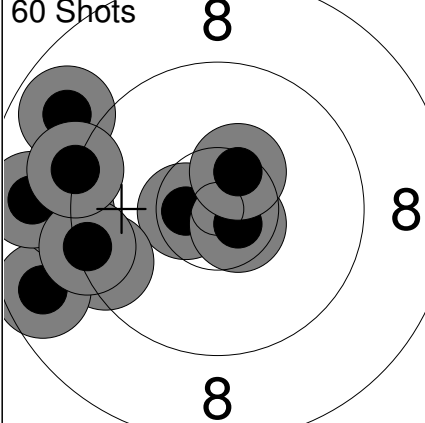
<p>Sight</p> 	<table border="1" style="width:100%; border-collapse: collapse;"> <tr><td>1:</td><td>9.0</td><td>↗</td></tr> <tr><td>2:</td><td>9.8</td><td>↗</td></tr> <tr><td>3:</td><td>8.8</td><td>→</td></tr> <tr><td>4:</td><td>9.4</td><td>↘</td></tr> <tr><td>5:</td><td>9.9</td><td>→</td></tr> <tr><td>6:</td><td>8.4</td><td>↘</td></tr> <tr><td>7:</td><td>9.4</td><td>→</td></tr> <tr><td>8:</td><td>8.9</td><td>↘</td></tr> <tr><td>9:</td><td>10.3</td><td>↘</td></tr> <tr><td>10:</td><td>9.6</td><td>↑</td></tr> <tr><td colspan="2">Series</td><td>88 (0x)</td></tr> <tr><td colspan="2"></td><td>0 (0x)</td></tr> </table>	1:	9.0	↗	2:	9.8	↗	3:	8.8	→	4:	9.4	↘	5:	9.9	→	6:	8.4	↘	7:	9.4	→	8:	8.9	↘	9:	10.3	↘	10:	9.6	↑	Series		88 (0x)			0 (0x)	<p>60 Shots</p>  <table border="1" style="width:100%; border-collapse: collapse;"> <tr><td>1:</td><td>9.7</td><td>→</td></tr> <tr><td>2:</td><td>9.7</td><td>↗</td></tr> <tr><td>3:</td><td>9.4</td><td>↘</td></tr> <tr><td>4:</td><td>9.6</td><td>→</td></tr> <tr><td>5:</td><td>9.5</td><td>↑</td></tr> <tr><td>6:</td><td>9.8</td><td>↗</td></tr> <tr><td>7:</td><td>9.1</td><td>↗</td></tr> <tr><td>8:</td><td>9.3</td><td>↗</td></tr> <tr><td>9:</td><td>9.3</td><td>↖</td></tr> <tr><td>10:</td><td>9.9</td><td>↗</td></tr> <tr><td colspan="2">Series</td><td>90 (0x)</td></tr> <tr><td colspan="2"></td><td>90 (0x)</td></tr> </table>	1:	9.7	→	2:	9.7	↗	3:	9.4	↘	4:	9.6	→	5:	9.5	↑	6:	9.8	↗	7:	9.1	↗	8:	9.3	↗	9:	9.3	↖	10:	9.9	↗	Series		90 (0x)			90 (0x)
1:	9.0	↗																																																																								
2:	9.8	↗																																																																								
3:	8.8	→																																																																								
4:	9.4	↘																																																																								
5:	9.9	→																																																																								
6:	8.4	↘																																																																								
7:	9.4	→																																																																								
8:	8.9	↘																																																																								
9:	10.3	↘																																																																								
10:	9.6	↑																																																																								
Series		88 (0x)																																																																								
		0 (0x)																																																																								
1:	9.7	→																																																																								
2:	9.7	↗																																																																								
3:	9.4	↘																																																																								
4:	9.6	→																																																																								
5:	9.5	↑																																																																								
6:	9.8	↗																																																																								
7:	9.1	↗																																																																								
8:	9.3	↗																																																																								
9:	9.3	↖																																																																								
10:	9.9	↗																																																																								
Series		90 (0x)																																																																								
		90 (0x)																																																																								
<p>60 Shots</p> 	<table border="1" style="width:100%; border-collapse: collapse;"> <tr><td>11:</td><td>9.5</td><td>↓</td></tr> <tr><td>12:</td><td>9.8</td><td>→</td></tr> <tr><td>13:</td><td>9.2</td><td>↑</td></tr> <tr><td>14:</td><td>10.2</td><td>↑</td></tr> <tr><td>15:</td><td>9.6</td><td>↖</td></tr> <tr><td>16:</td><td>9.6</td><td>↗</td></tr> <tr><td>17:</td><td>10.1</td><td>↑</td></tr> <tr><td>18:</td><td>9.1</td><td>↖</td></tr> <tr><td>19:</td><td>10.2</td><td>↘</td></tr> <tr><td>20:</td><td>8.3</td><td>↗</td></tr> <tr><td colspan="2">Series</td><td>92 (0x)</td></tr> <tr><td colspan="2"></td><td>182 (0x)</td></tr> </table>	11:	9.5	↓	12:	9.8	→	13:	9.2	↑	14:	10.2	↑	15:	9.6	↖	16:	9.6	↗	17:	10.1	↑	18:	9.1	↖	19:	10.2	↘	20:	8.3	↗	Series		92 (0x)			182 (0x)	<p>60 Shots</p>  <table border="1" style="width:100%; border-collapse: collapse;"> <tr><td>21:</td><td>9.2</td><td>↑</td></tr> <tr><td>22:</td><td>10.5x</td><td>↗</td></tr> <tr><td>23:</td><td>9.8</td><td>→</td></tr> <tr><td>24:</td><td>9.0</td><td>↖</td></tr> <tr><td>25:</td><td>9.8</td><td>↖</td></tr> <tr><td>26:</td><td>10.1</td><td>↗</td></tr> <tr><td>27:</td><td>9.9</td><td>↑</td></tr> <tr><td>28:</td><td>8.3</td><td>↗</td></tr> <tr><td>29:</td><td>8.8</td><td>↑</td></tr> <tr><td>30:</td><td>9.1</td><td>↖</td></tr> <tr><td colspan="2">Series</td><td>90 (1x)</td></tr> <tr><td colspan="2"></td><td>272 (1x)</td></tr> </table>	21:	9.2	↑	22:	10.5x	↗	23:	9.8	→	24:	9.0	↖	25:	9.8	↖	26:	10.1	↗	27:	9.9	↑	28:	8.3	↗	29:	8.8	↑	30:	9.1	↖	Series		90 (1x)			272 (1x)
11:	9.5	↓																																																																								
12:	9.8	→																																																																								
13:	9.2	↑																																																																								
14:	10.2	↑																																																																								
15:	9.6	↖																																																																								
16:	9.6	↗																																																																								
17:	10.1	↑																																																																								
18:	9.1	↖																																																																								
19:	10.2	↘																																																																								
20:	8.3	↗																																																																								
Series		92 (0x)																																																																								
		182 (0x)																																																																								
21:	9.2	↑																																																																								
22:	10.5x	↗																																																																								
23:	9.8	→																																																																								
24:	9.0	↖																																																																								
25:	9.8	↖																																																																								
26:	10.1	↗																																																																								
27:	9.9	↑																																																																								
28:	8.3	↗																																																																								
29:	8.8	↑																																																																								
30:	9.1	↖																																																																								
Series		90 (1x)																																																																								
		272 (1x)																																																																								
<p>60 Shots</p> 	<table border="1" style="width:100%; border-collapse: collapse;"> <tr><td>31:</td><td>8.2</td><td>↖</td></tr> <tr><td>32:</td><td>9.8</td><td>↖</td></tr> <tr><td>33:</td><td>10.3</td><td>↖</td></tr> <tr><td>34:</td><td>9.5</td><td>↖</td></tr> <tr><td>35:</td><td>7.8</td><td>↖</td></tr> <tr><td>36:</td><td>10.0</td><td>→</td></tr> <tr><td>37:</td><td>9.0</td><td>↗</td></tr> <tr><td>38:</td><td>10.0</td><td>↗</td></tr> <tr><td>39:</td><td>9.3</td><td>→</td></tr> <tr><td>40:</td><td>9.6</td><td>↓</td></tr> <tr><td colspan="2">Series</td><td>90 (0x)</td></tr> <tr><td colspan="2"></td><td>362 (1x)</td></tr> </table>	31:	8.2	↖	32:	9.8	↖	33:	10.3	↖	34:	9.5	↖	35:	7.8	↖	36:	10.0	→	37:	9.0	↗	38:	10.0	↗	39:	9.3	→	40:	9.6	↓	Series		90 (0x)			362 (1x)	<p>60 Shots</p>  <table border="1" style="width:100%; border-collapse: collapse;"> <tr><td>41:</td><td>9.3</td><td>↑</td></tr> <tr><td>42:</td><td>10.6x</td><td>↘</td></tr> <tr><td>43:</td><td>9.1</td><td>↗</td></tr> <tr><td>44:</td><td>9.6</td><td>↖</td></tr> <tr><td>45:</td><td>10.1</td><td>↘</td></tr> <tr><td>46:</td><td>9.2</td><td>↖</td></tr> <tr><td>47:</td><td>10.0</td><td>↖</td></tr> <tr><td>48:</td><td>9.7</td><td>→</td></tr> <tr><td>49:</td><td>8.8</td><td>↗</td></tr> <tr><td>50:</td><td>8.2</td><td>↘</td></tr> <tr><td colspan="2">Series</td><td>91 (1x)</td></tr> <tr><td colspan="2"></td><td>453 (2x)</td></tr> </table>	41:	9.3	↑	42:	10.6x	↘	43:	9.1	↗	44:	9.6	↖	45:	10.1	↘	46:	9.2	↖	47:	10.0	↖	48:	9.7	→	49:	8.8	↗	50:	8.2	↘	Series		91 (1x)			453 (2x)
31:	8.2	↖																																																																								
32:	9.8	↖																																																																								
33:	10.3	↖																																																																								
34:	9.5	↖																																																																								
35:	7.8	↖																																																																								
36:	10.0	→																																																																								
37:	9.0	↗																																																																								
38:	10.0	↗																																																																								
39:	9.3	→																																																																								
40:	9.6	↓																																																																								
Series		90 (0x)																																																																								
		362 (1x)																																																																								
41:	9.3	↑																																																																								
42:	10.6x	↘																																																																								
43:	9.1	↗																																																																								
44:	9.6	↖																																																																								
45:	10.1	↘																																																																								
46:	9.2	↖																																																																								
47:	10.0	↖																																																																								
48:	9.7	→																																																																								
49:	8.8	↗																																																																								
50:	8.2	↘																																																																								
Series		91 (1x)																																																																								
		453 (2x)																																																																								
<p>60 Shots</p> 	<table border="1" style="width:100%; border-collapse: collapse;"> <tr><td>51:</td><td>10.6x</td><td>↖</td></tr> <tr><td>52:</td><td>10.6x</td><td>↘</td></tr> <tr><td>53:</td><td>9.5</td><td>↖</td></tr> <tr><td>54:</td><td>8.7</td><td>↖</td></tr> <tr><td>55:</td><td>9.2</td><td>↖</td></tr> <tr><td>56:</td><td>8.8</td><td>↖</td></tr> <tr><td>57:</td><td>9.4</td><td>↖</td></tr> <tr><td>58:</td><td>8.9</td><td>↗</td></tr> <tr><td>59:</td><td>10.5x</td><td>↗</td></tr> <tr><td>60:</td><td>9.2</td><td>↖</td></tr> <tr><td colspan="2">Series</td><td>90 (3x)</td></tr> <tr><td colspan="2"></td><td>543 (5x)</td></tr> </table>	51:	10.6x	↖	52:	10.6x	↘	53:	9.5	↖	54:	8.7	↖	55:	9.2	↖	56:	8.8	↖	57:	9.4	↖	58:	8.9	↗	59:	10.5x	↗	60:	9.2	↖	Series		90 (3x)			543 (5x)																																					
51:	10.6x	↖																																																																								
52:	10.6x	↘																																																																								
53:	9.5	↖																																																																								
54:	8.7	↖																																																																								
55:	9.2	↖																																																																								
56:	8.8	↖																																																																								
57:	9.4	↖																																																																								
58:	8.9	↗																																																																								
59:	10.5x	↗																																																																								
60:	9.2	↖																																																																								
Series		90 (3x)																																																																								
		543 (5x)																																																																								

Relay 1	Lane 10	EK Nils
-------------------	-------------------	----------------

2023 SFC Pistol Nationals	QC	EX	MP
---------------------------	----	----	----

15.07.2023	PN23AP-Q-1	Alberta Handgun Association
------------	------------	-----------------------------

Comment	Signature
---------	-----------

<p>Sight</p>	<table style="width:100%; border-collapse: collapse;"> <tr><td>1:</td><td>8.1</td><td>↙</td></tr> <tr><td>2:</td><td>8.5</td><td>↙</td></tr> <tr><td>3:</td><td>9.7</td><td>→</td></tr> <tr><td>4:</td><td>9.4</td><td>←</td></tr> <tr><td>5:</td><td>10.8x</td><td>↑</td></tr> <tr><td>6:</td><td>9.0</td><td>↖</td></tr> <tr><td>7:</td><td>7.2</td><td>↑</td></tr> <tr><td>8:</td><td>9.7</td><td>↖</td></tr> <tr><td>9:</td><td>8.5</td><td>↗</td></tr> <tr><td>10:</td><td>8.1</td><td>↓</td></tr> <tr><td colspan="2">Series</td><td>85 (1x)</td></tr> <tr><td colspan="2"></td><td>0 (0x)</td></tr> </table>	1:	8.1	↙	2:	8.5	↙	3:	9.7	→	4:	9.4	←	5:	10.8x	↑	6:	9.0	↖	7:	7.2	↑	8:	9.7	↖	9:	8.5	↗	10:	8.1	↓	Series		85 (1x)			0 (0x)	<p>Sight</p>	<table style="width:100%; border-collapse: collapse;"> <tr><td>11:</td><td>7.8</td><td>↗</td></tr> <tr><td>12:</td><td>4.9</td><td>→</td></tr> <tr><td>13:</td><td>6.6</td><td>→</td></tr> <tr><td colspan="2">Series</td><td>17 (0x)</td></tr> <tr><td colspan="2"></td><td>0 (0x)</td></tr> </table>	11:	7.8	↗	12:	4.9	→	13:	6.6	→	Series		17 (0x)			0 (0x)																					
1:	8.1	↙																																																																									
2:	8.5	↙																																																																									
3:	9.7	→																																																																									
4:	9.4	←																																																																									
5:	10.8x	↑																																																																									
6:	9.0	↖																																																																									
7:	7.2	↑																																																																									
8:	9.7	↖																																																																									
9:	8.5	↗																																																																									
10:	8.1	↓																																																																									
Series		85 (1x)																																																																									
		0 (0x)																																																																									
11:	7.8	↗																																																																									
12:	4.9	→																																																																									
13:	6.6	→																																																																									
Series		17 (0x)																																																																									
		0 (0x)																																																																									
<p>60 Shots</p>	<table style="width:100%; border-collapse: collapse;"> <tr><td>1:</td><td>8.9</td><td>↙</td></tr> <tr><td>2:</td><td>8.3</td><td>↗</td></tr> <tr><td>3:</td><td>10.0</td><td>←</td></tr> <tr><td>4:</td><td>7.9</td><td>↗</td></tr> <tr><td>5:</td><td>8.9</td><td>↗</td></tr> <tr><td>6:</td><td>9.2</td><td>↖</td></tr> <tr><td>7:</td><td>5.3</td><td>↗</td></tr> <tr><td>8:</td><td>10.1</td><td>→</td></tr> <tr><td>9:</td><td>8.6</td><td>↗</td></tr> <tr><td>10:</td><td>9.4</td><td>↗</td></tr> <tr><td colspan="2">Series</td><td>82 (0x)</td></tr> <tr><td colspan="2"></td><td>82 (0x)</td></tr> </table>	1:	8.9	↙	2:	8.3	↗	3:	10.0	←	4:	7.9	↗	5:	8.9	↗	6:	9.2	↖	7:	5.3	↗	8:	10.1	→	9:	8.6	↗	10:	9.4	↗	Series		82 (0x)			82 (0x)	<p>60 Shots</p>	<table style="width:100%; border-collapse: collapse;"> <tr><td>11:</td><td>8.2</td><td>↑</td></tr> <tr><td>12:</td><td>9.4</td><td>↗</td></tr> <tr><td>13:</td><td>7.3</td><td>↗</td></tr> <tr><td>14:</td><td>8.1</td><td>→</td></tr> <tr><td>15:</td><td>8.6</td><td>↑</td></tr> <tr><td>16:</td><td>9.6</td><td>↗</td></tr> <tr><td>17:</td><td>10.3</td><td>←</td></tr> <tr><td>18:</td><td>4.9</td><td>↗</td></tr> <tr><td>19:</td><td>9.8</td><td>→</td></tr> <tr><td>20:</td><td>9.5</td><td>↑</td></tr> <tr><td colspan="2">Series</td><td>81 (0x)</td></tr> <tr><td colspan="2"></td><td>163 (0x)</td></tr> </table>	11:	8.2	↑	12:	9.4	↗	13:	7.3	↗	14:	8.1	→	15:	8.6	↑	16:	9.6	↗	17:	10.3	←	18:	4.9	↗	19:	9.8	→	20:	9.5	↑	Series		81 (0x)			163 (0x)
1:	8.9	↙																																																																									
2:	8.3	↗																																																																									
3:	10.0	←																																																																									
4:	7.9	↗																																																																									
5:	8.9	↗																																																																									
6:	9.2	↖																																																																									
7:	5.3	↗																																																																									
8:	10.1	→																																																																									
9:	8.6	↗																																																																									
10:	9.4	↗																																																																									
Series		82 (0x)																																																																									
		82 (0x)																																																																									
11:	8.2	↑																																																																									
12:	9.4	↗																																																																									
13:	7.3	↗																																																																									
14:	8.1	→																																																																									
15:	8.6	↑																																																																									
16:	9.6	↗																																																																									
17:	10.3	←																																																																									
18:	4.9	↗																																																																									
19:	9.8	→																																																																									
20:	9.5	↑																																																																									
Series		81 (0x)																																																																									
		163 (0x)																																																																									
<p>60 Shots</p>	<table style="width:100%; border-collapse: collapse;"> <tr><td>21:</td><td>8.8</td><td>↑</td></tr> <tr><td>22:</td><td>8.5</td><td>↑</td></tr> <tr><td>23:</td><td>8.4</td><td>←</td></tr> <tr><td>24:</td><td>8.9</td><td>↑</td></tr> <tr><td>25:</td><td>9.1</td><td>←</td></tr> <tr><td>26:</td><td>8.5</td><td>→</td></tr> <tr><td>27:</td><td>9.4</td><td>↗</td></tr> <tr><td>28:</td><td>8.7</td><td>↑</td></tr> <tr><td>29:</td><td>7.8</td><td>↓</td></tr> <tr><td>30:</td><td>8.9</td><td>↗</td></tr> <tr><td colspan="2">Series</td><td>81 (0x)</td></tr> <tr><td colspan="2"></td><td>244 (0x)</td></tr> </table>	21:	8.8	↑	22:	8.5	↑	23:	8.4	←	24:	8.9	↑	25:	9.1	←	26:	8.5	→	27:	9.4	↗	28:	8.7	↑	29:	7.8	↓	30:	8.9	↗	Series		81 (0x)			244 (0x)	<p>60 Shots</p>	<table style="width:100%; border-collapse: collapse;"> <tr><td>31:</td><td>9.3</td><td>↗</td></tr> <tr><td>32:</td><td>8.4</td><td>←</td></tr> <tr><td>33:</td><td>10.1</td><td>↑</td></tr> <tr><td>34:</td><td>7.6</td><td>→</td></tr> <tr><td>35:</td><td>10.3</td><td>↖</td></tr> <tr><td>36:</td><td>10.1</td><td>←</td></tr> <tr><td>37:</td><td>9.2</td><td>←</td></tr> <tr><td>38:</td><td>10.2</td><td>↗</td></tr> <tr><td>39:</td><td>6.9</td><td>↘</td></tr> <tr><td>40:</td><td>9.7</td><td>↑</td></tr> <tr><td colspan="2">Series</td><td>88 (0x)</td></tr> <tr><td colspan="2"></td><td>332 (0x)</td></tr> </table>	31:	9.3	↗	32:	8.4	←	33:	10.1	↑	34:	7.6	→	35:	10.3	↖	36:	10.1	←	37:	9.2	←	38:	10.2	↗	39:	6.9	↘	40:	9.7	↑	Series		88 (0x)			332 (0x)
21:	8.8	↑																																																																									
22:	8.5	↑																																																																									
23:	8.4	←																																																																									
24:	8.9	↑																																																																									
25:	9.1	←																																																																									
26:	8.5	→																																																																									
27:	9.4	↗																																																																									
28:	8.7	↑																																																																									
29:	7.8	↓																																																																									
30:	8.9	↗																																																																									
Series		81 (0x)																																																																									
		244 (0x)																																																																									
31:	9.3	↗																																																																									
32:	8.4	←																																																																									
33:	10.1	↑																																																																									
34:	7.6	→																																																																									
35:	10.3	↖																																																																									
36:	10.1	←																																																																									
37:	9.2	←																																																																									
38:	10.2	↗																																																																									
39:	6.9	↘																																																																									
40:	9.7	↑																																																																									
Series		88 (0x)																																																																									
		332 (0x)																																																																									
<p>60 Shots</p>	<table style="width:100%; border-collapse: collapse;"> <tr><td>41:</td><td>7.8</td><td>↗</td></tr> <tr><td>42:</td><td>9.5</td><td>↗</td></tr> <tr><td>43:</td><td>8.2</td><td>→</td></tr> <tr><td>44:</td><td>10.4x</td><td>←</td></tr> <tr><td>45:</td><td>9.9</td><td>↓</td></tr> <tr><td>46:</td><td>7.8</td><td>↖</td></tr> <tr><td>47:</td><td>9.2</td><td>↘</td></tr> <tr><td>48:</td><td>9.9</td><td>↑</td></tr> <tr><td>49:</td><td>9.3</td><td>↖</td></tr> <tr><td>50:</td><td>8.8</td><td>←</td></tr> <tr><td colspan="2">Series</td><td>85 (1x)</td></tr> <tr><td colspan="2"></td><td>417 (1x)</td></tr> </table>	41:	7.8	↗	42:	9.5	↗	43:	8.2	→	44:	10.4x	←	45:	9.9	↓	46:	7.8	↖	47:	9.2	↘	48:	9.9	↑	49:	9.3	↖	50:	8.8	←	Series		85 (1x)			417 (1x)	<p>60 Shots</p>	<table style="width:100%; border-collapse: collapse;"> <tr><td>51:</td><td>10.1</td><td>→</td></tr> <tr><td>52:</td><td>8.7</td><td>↖</td></tr> <tr><td>53:</td><td>8.8</td><td>↗</td></tr> <tr><td>54:</td><td>7.0</td><td>←</td></tr> <tr><td>55:</td><td>9.7</td><td>↖</td></tr> <tr><td>56:</td><td>8.8</td><td>→</td></tr> <tr><td>57:</td><td>9.1</td><td>→</td></tr> <tr><td>58:</td><td>8.8</td><td>←</td></tr> <tr><td>59:</td><td>9.4</td><td>↓</td></tr> <tr><td>60:</td><td>8.5</td><td>→</td></tr> <tr><td colspan="2">Series</td><td>84 (0x)</td></tr> <tr><td colspan="2"></td><td>501 (1x)</td></tr> </table>	51:	10.1	→	52:	8.7	↖	53:	8.8	↗	54:	7.0	←	55:	9.7	↖	56:	8.8	→	57:	9.1	→	58:	8.8	←	59:	9.4	↓	60:	8.5	→	Series		84 (0x)			501 (1x)
41:	7.8	↗																																																																									
42:	9.5	↗																																																																									
43:	8.2	→																																																																									
44:	10.4x	←																																																																									
45:	9.9	↓																																																																									
46:	7.8	↖																																																																									
47:	9.2	↘																																																																									
48:	9.9	↑																																																																									
49:	9.3	↖																																																																									
50:	8.8	←																																																																									
Series		85 (1x)																																																																									
		417 (1x)																																																																									
51:	10.1	→																																																																									
52:	8.7	↖																																																																									
53:	8.8	↗																																																																									
54:	7.0	←																																																																									
55:	9.7	↖																																																																									
56:	8.8	→																																																																									
57:	9.1	→																																																																									
58:	8.8	←																																																																									
59:	9.4	↓																																																																									
60:	8.5	→																																																																									
Series		84 (0x)																																																																									
		501 (1x)																																																																									

Comment	Signature
---------	-----------

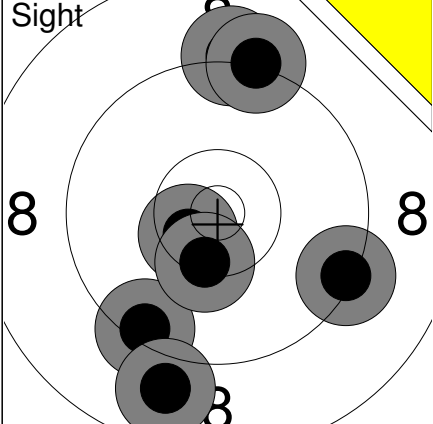
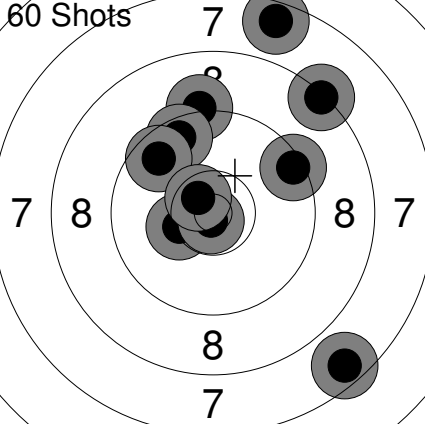
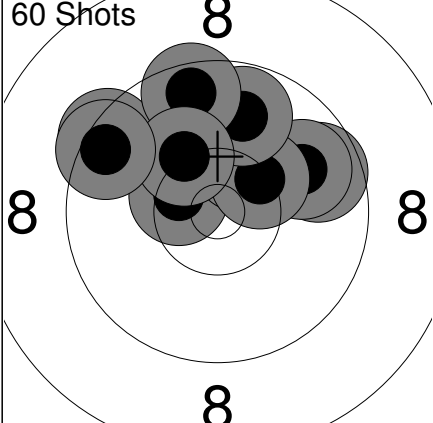
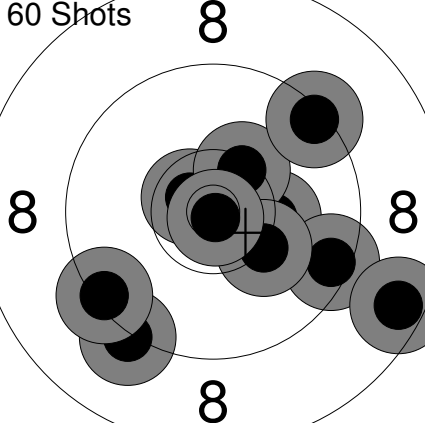
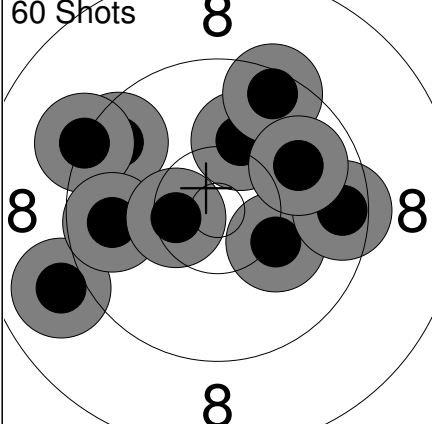
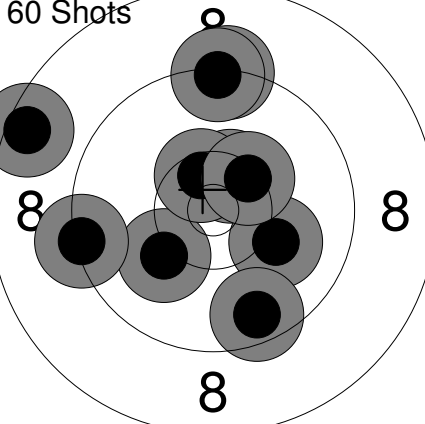
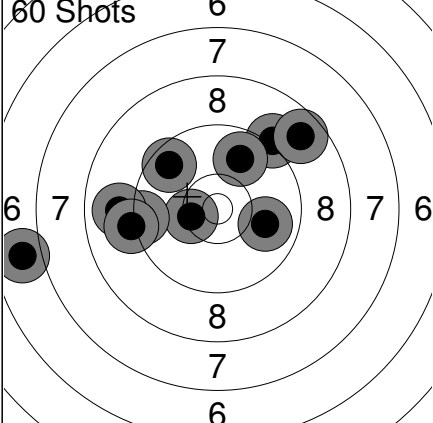
<p>Sight</p> 	<p>60 Shots</p> 	<p>1: 9.4 ↘ 2: 10.5x ← 3: 9.2 ↑ 4: 9.3 → 5: 8.9 ↓ 6: 10.4x ↓ 7: 9.2 ↑</p> <p>Series 64 (2x) 0 (0x)</p>	<p>1: 8.3 ↗ 2: 10.3 ← 3: 7.6 ↓ 4: 9.4 → 5: 9.2 ↑ 6: 10.8x ↓ 7: 9.6 ↑ 8: 9.7 ↗ 9: 7.5 ↑ 10: 10.6x ↖</p> <p>Series 88 (2x) 88 (2x)</p>
<p>60 Shots</p> 	<p>60 Shots</p> 	<p>11: 9.7 → 12: 10.5x ↖ 13: 9.4 ↗ 14: 9.9 → 15: 10.3 ↑ 16: 10.3 ↗ 17: 9.8 ↑ 18: 9.6 ↑ 19: 10.2 ↑ 20: 9.5 ↖</p> <p>Series 94 (1x) 182 (3x)</p>	<p>21: 9.2 ↓ 22: 10.6x ↖ 23: 10.3 → 24: 9.5 → 25: 10.4x ↑ 26: 9.4 ↗ 27: 10.2 ↘ 28: 10.9x ↓ 29: 9.3 ↙ 30: 8.5 ↘</p> <p>Series 94 (3x) 276 (6x)</p>
<p>60 Shots</p> 	<p>60 Shots</p> 	<p>31: 10.2 → 32: 9.6 ↗ 33: 9.3 ↗ 34: 9.0 ← 35: 9.7 ← 36: 10.1 ↑ 37: 10.5x ← 38: 9.5 ↑ 39: 9.5 → 40: 9.9 →</p> <p>Series 93 (1x) 369 (7x)</p>	<p>41: 10.5x ↑ 42: 9.3 ↑ 43: 10.1 → 44: 9.6 ↓ 45: 10.1 ↙ 46: 9.3 ↑ 47: 9.3 ← 48: 10.5x ↑ 49: 10.4x ↗ 50: 8.5 ↖</p> <p>Series 94 (3x) 463 (10x)</p>
<p>60 Shots</p> 		<p>51: 9.2 ↗ 52: 10.4x ← 53: 9.6 ↗ 54: 9.8 ↑ 55: 9.4 ← 56: 8.9 ← 57: 9.9 → 58: 6.8 ← 59: 8.7 ↗ 60: 9.1 ←</p> <p>Series 86 (1x) 549 (11x)</p>	

Relay 1	Lane 13	BURNS Stuart
-------------------	-------------------	---------------------

2023 SFC Pistol Nationals	ON	EX	MP
---------------------------	----	----	----

15.07.2023	PN23AP-Q-1	Alberta Handgun Association
------------	------------	-----------------------------

Comment	Signature
---------	-----------

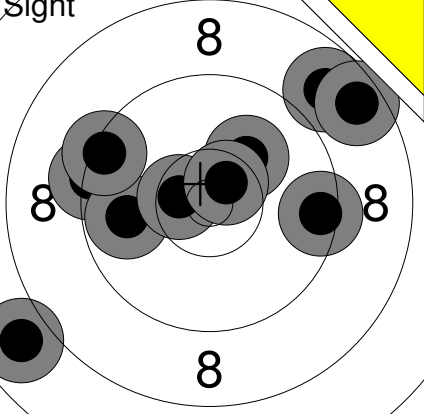
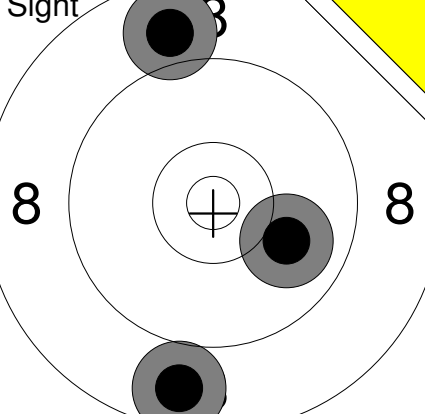
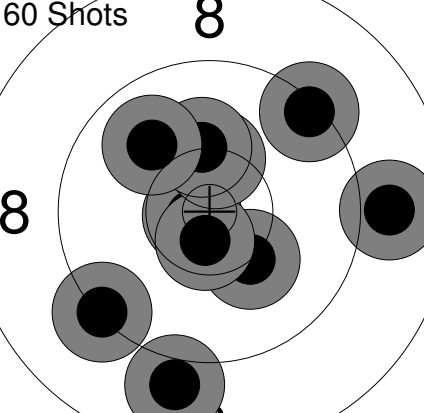
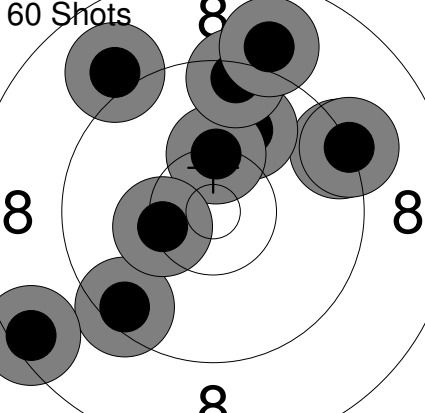
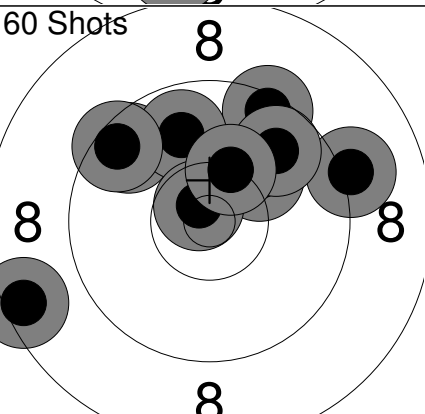
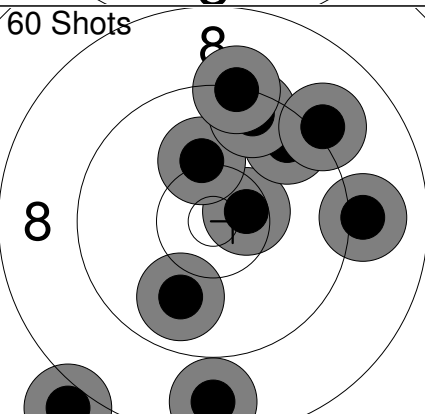
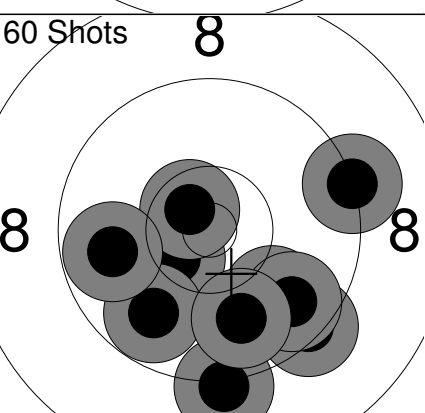
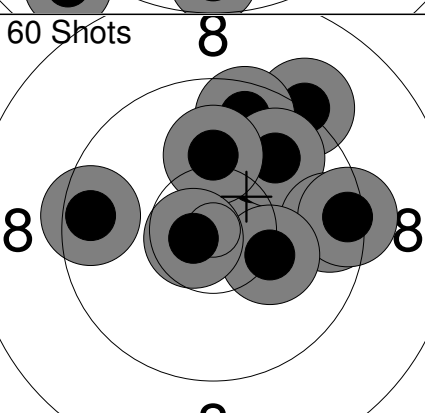
<p>Sight</p> 	<table border="1" style="width:100%; border-collapse: collapse;"> <tr><td>1:</td><td>10.2</td><td>↗</td></tr> <tr><td>2:</td><td>9.3</td><td>←</td></tr> <tr><td>3:</td><td>9.8</td><td>←</td></tr> <tr><td>4:</td><td>7.8</td><td>←</td></tr> <tr><td>5:</td><td>9.4</td><td>↖</td></tr> <tr><td>6:</td><td>8.8</td><td>↗</td></tr> <tr><td>7:</td><td>10.5x</td><td>←</td></tr> <tr><td>8:</td><td>10.6x</td><td>↗</td></tr> <tr><td>9:</td><td>8.6</td><td>↗</td></tr> <tr><td>10:</td><td>9.5</td><td>→</td></tr> <tr><td colspan="2">Series</td><td>89 (2x)</td></tr> <tr><td colspan="2"></td><td>0 (0x)</td></tr> </table>	1:	10.2	↗	2:	9.3	←	3:	9.8	←	4:	7.8	←	5:	9.4	↖	6:	8.8	↗	7:	10.5x	←	8:	10.6x	↗	9:	8.6	↗	10:	9.5	→	Series		89 (2x)			0 (0x)	<p>Sight</p> 	<table border="1" style="width:100%; border-collapse: collapse;"> <tr><td>11:</td><td>8.9</td><td>↖</td></tr> <tr><td>12:</td><td>8.7</td><td>↓</td></tr> <tr><td>13:</td><td>10.0</td><td>↘</td></tr> <tr><td colspan="2">Series</td><td>26 (0x)</td></tr> <tr><td colspan="2"></td><td>0 (0x)</td></tr> </table>	11:	8.9	↖	12:	8.7	↓	13:	10.0	↘	Series		26 (0x)			0 (0x)																					
1:	10.2	↗																																																																									
2:	9.3	←																																																																									
3:	9.8	←																																																																									
4:	7.8	←																																																																									
5:	9.4	↖																																																																									
6:	8.8	↗																																																																									
7:	10.5x	←																																																																									
8:	10.6x	↗																																																																									
9:	8.6	↗																																																																									
10:	9.5	→																																																																									
Series		89 (2x)																																																																									
		0 (0x)																																																																									
11:	8.9	↖																																																																									
12:	8.7	↓																																																																									
13:	10.0	↘																																																																									
Series		26 (0x)																																																																									
		0 (0x)																																																																									
<p>60 Shots</p> 	<table border="1" style="width:100%; border-collapse: collapse;"> <tr><td>1:</td><td>10.2</td><td>↘</td></tr> <tr><td>2:</td><td>9.3</td><td>←</td></tr> <tr><td>3:</td><td>10.7x</td><td>←</td></tr> <tr><td>4:</td><td>8.9</td><td>→</td></tr> <tr><td>5:</td><td>10.6x</td><td>↓</td></tr> <tr><td>6:</td><td>9.3</td><td>↗</td></tr> <tr><td>7:</td><td>10.3</td><td>↑</td></tr> <tr><td>8:</td><td>8.9</td><td>↓</td></tr> <tr><td>9:</td><td>10.2</td><td>↑</td></tr> <tr><td>10:</td><td>10.0</td><td>↖</td></tr> <tr><td colspan="2">Series</td><td>94 (2x)</td></tr> <tr><td colspan="2"></td><td>94 (2x)</td></tr> </table>	1:	10.2	↘	2:	9.3	←	3:	10.7x	←	4:	8.9	→	5:	10.6x	↓	6:	9.3	↗	7:	10.3	↑	8:	8.9	↓	9:	10.2	↑	10:	10.0	↖	Series		94 (2x)			94 (2x)	<p>60 Shots</p> 	<table border="1" style="width:100%; border-collapse: collapse;"> <tr><td>11:</td><td>9.4</td><td>↗</td></tr> <tr><td>12:</td><td>9.0</td><td>↖</td></tr> <tr><td>13:</td><td>9.5</td><td>↘</td></tr> <tr><td>14:</td><td>8.4</td><td>←</td></tr> <tr><td>15:</td><td>9.9</td><td>↑</td></tr> <tr><td>16:</td><td>10.3</td><td>↑</td></tr> <tr><td>17:</td><td>9.4</td><td>↑</td></tr> <tr><td>18:</td><td>9.0</td><td>↑</td></tr> <tr><td>19:</td><td>10.4</td><td>←</td></tr> <tr><td>20:</td><td>9.2</td><td>↗</td></tr> <tr><td colspan="2">Series</td><td>91 (0x)</td></tr> <tr><td colspan="2"></td><td>185 (2x)</td></tr> </table>	11:	9.4	↗	12:	9.0	↖	13:	9.5	↘	14:	8.4	←	15:	9.9	↑	16:	10.3	↑	17:	9.4	↑	18:	9.0	↑	19:	10.4	←	20:	9.2	↗	Series		91 (0x)			185 (2x)
1:	10.2	↘																																																																									
2:	9.3	←																																																																									
3:	10.7x	←																																																																									
4:	8.9	→																																																																									
5:	10.6x	↓																																																																									
6:	9.3	↗																																																																									
7:	10.3	↑																																																																									
8:	8.9	↓																																																																									
9:	10.2	↑																																																																									
10:	10.0	↖																																																																									
Series		94 (2x)																																																																									
		94 (2x)																																																																									
11:	9.4	↗																																																																									
12:	9.0	↖																																																																									
13:	9.5	↘																																																																									
14:	8.4	←																																																																									
15:	9.9	↑																																																																									
16:	10.3	↑																																																																									
17:	9.4	↑																																																																									
18:	9.0	↑																																																																									
19:	10.4	←																																																																									
20:	9.2	↗																																																																									
Series		91 (0x)																																																																									
		185 (2x)																																																																									
<p>60 Shots</p> 	<table border="1" style="width:100%; border-collapse: collapse;"> <tr><td>21:</td><td>9.6</td><td>↖</td></tr> <tr><td>22:</td><td>9.1</td><td>→</td></tr> <tr><td>23:</td><td>9.4</td><td>↗</td></tr> <tr><td>24:</td><td>10.1</td><td>↗</td></tr> <tr><td>25:</td><td>9.8</td><td>↖</td></tr> <tr><td>26:</td><td>8.5</td><td>←</td></tr> <tr><td>27:</td><td>9.5</td><td>↗</td></tr> <tr><td>28:</td><td>9.8</td><td>↗</td></tr> <tr><td>29:</td><td>10.7x</td><td>↗</td></tr> <tr><td>30:</td><td>10.3</td><td>↗</td></tr> <tr><td colspan="2">Series</td><td>92 (1x)</td></tr> <tr><td colspan="2"></td><td>277 (3x)</td></tr> </table>	21:	9.6	↖	22:	9.1	→	23:	9.4	↗	24:	10.1	↗	25:	9.8	↖	26:	8.5	←	27:	9.5	↗	28:	9.8	↗	29:	10.7x	↗	30:	10.3	↗	Series		92 (1x)			277 (3x)	<p>60 Shots</p> 	<table border="1" style="width:100%; border-collapse: collapse;"> <tr><td>31:</td><td>9.1</td><td>→</td></tr> <tr><td>32:</td><td>8.7</td><td>↓</td></tr> <tr><td>33:</td><td>10.5x</td><td>→</td></tr> <tr><td>34:</td><td>10.2</td><td>↑</td></tr> <tr><td>35:</td><td>9.6</td><td>↗</td></tr> <tr><td>36:</td><td>9.9</td><td>↓</td></tr> <tr><td>37:</td><td>8.0</td><td>↘</td></tr> <tr><td>38:</td><td>9.5</td><td>↑</td></tr> <tr><td>39:</td><td>9.1</td><td>↗</td></tr> <tr><td>40:</td><td>9.3</td><td>↑</td></tr> <tr><td colspan="2">Series</td><td>90 (1x)</td></tr> <tr><td colspan="2"></td><td>367 (4x)</td></tr> </table>	31:	9.1	→	32:	8.7	↓	33:	10.5x	→	34:	10.2	↑	35:	9.6	↗	36:	9.9	↓	37:	8.0	↘	38:	9.5	↑	39:	9.1	↗	40:	9.3	↑	Series		90 (1x)			367 (4x)
21:	9.6	↖																																																																									
22:	9.1	→																																																																									
23:	9.4	↗																																																																									
24:	10.1	↗																																																																									
25:	9.8	↖																																																																									
26:	8.5	←																																																																									
27:	9.5	↗																																																																									
28:	9.8	↗																																																																									
29:	10.7x	↗																																																																									
30:	10.3	↗																																																																									
Series		92 (1x)																																																																									
		277 (3x)																																																																									
31:	9.1	→																																																																									
32:	8.7	↓																																																																									
33:	10.5x	→																																																																									
34:	10.2	↑																																																																									
35:	9.6	↗																																																																									
36:	9.9	↓																																																																									
37:	8.0	↘																																																																									
38:	9.5	↑																																																																									
39:	9.1	↗																																																																									
40:	9.3	↑																																																																									
Series		90 (1x)																																																																									
		367 (4x)																																																																									
<p>60 Shots</p> 	<table border="1" style="width:100%; border-collapse: collapse;"> <tr><td>41:</td><td>9.9</td><td>↘</td></tr> <tr><td>42:</td><td>10.4x</td><td>←</td></tr> <tr><td>43:</td><td>9.2</td><td>↓</td></tr> <tr><td>44:</td><td>9.2</td><td>→</td></tr> <tr><td>45:</td><td>10.6x</td><td>↗</td></tr> <tr><td>46:</td><td>9.4</td><td>↘</td></tr> <tr><td>47:</td><td>9.8</td><td>↘</td></tr> <tr><td>48:</td><td>9.7</td><td>↘</td></tr> <tr><td>49:</td><td>9.9</td><td>↓</td></tr> <tr><td>50:</td><td>9.8</td><td>←</td></tr> <tr><td colspan="2">Series</td><td>92 (2x)</td></tr> <tr><td colspan="2"></td><td>459 (6x)</td></tr> </table>	41:	9.9	↘	42:	10.4x	←	43:	9.2	↓	44:	9.2	→	45:	10.6x	↗	46:	9.4	↘	47:	9.8	↘	48:	9.7	↘	49:	9.9	↓	50:	9.8	←	Series		92 (2x)			459 (6x)	<p>60 Shots</p> 	<table border="1" style="width:100%; border-collapse: collapse;"> <tr><td>51:</td><td>9.2</td><td>↗</td></tr> <tr><td>52:</td><td>9.6</td><td>←</td></tr> <tr><td>53:</td><td>10.2</td><td>↗</td></tr> <tr><td>54:</td><td>9.6</td><td>↑</td></tr> <tr><td>55:</td><td>9.9</td><td>↗</td></tr> <tr><td>56:</td><td>10.1</td><td>↑</td></tr> <tr><td>57:</td><td>9.6</td><td>→</td></tr> <tr><td>58:</td><td>9.4</td><td>→</td></tr> <tr><td>59:</td><td>10.2</td><td>↘</td></tr> <tr><td>60:</td><td>10.7x</td><td>←</td></tr> <tr><td colspan="2">Series</td><td>94 (1x)</td></tr> <tr><td colspan="2"></td><td>553 (7x)</td></tr> </table>	51:	9.2	↗	52:	9.6	←	53:	10.2	↗	54:	9.6	↑	55:	9.9	↗	56:	10.1	↑	57:	9.6	→	58:	9.4	→	59:	10.2	↘	60:	10.7x	←	Series		94 (1x)			553 (7x)
41:	9.9	↘																																																																									
42:	10.4x	←																																																																									
43:	9.2	↓																																																																									
44:	9.2	→																																																																									
45:	10.6x	↗																																																																									
46:	9.4	↘																																																																									
47:	9.8	↘																																																																									
48:	9.7	↘																																																																									
49:	9.9	↓																																																																									
50:	9.8	←																																																																									
Series		92 (2x)																																																																									
		459 (6x)																																																																									
51:	9.2	↗																																																																									
52:	9.6	←																																																																									
53:	10.2	↗																																																																									
54:	9.6	↑																																																																									
55:	9.9	↗																																																																									
56:	10.1	↑																																																																									
57:	9.6	→																																																																									
58:	9.4	→																																																																									
59:	10.2	↘																																																																									
60:	10.7x	←																																																																									
Series		94 (1x)																																																																									
		553 (7x)																																																																									

Relay **1** Lane **14** **PADDA Davinderjit (dave)**

2023 SFC Pistol Nationals BC EX MP

15.07.2023 PN23AP-Q-1 Alberta Handgun Association

Comment Signature

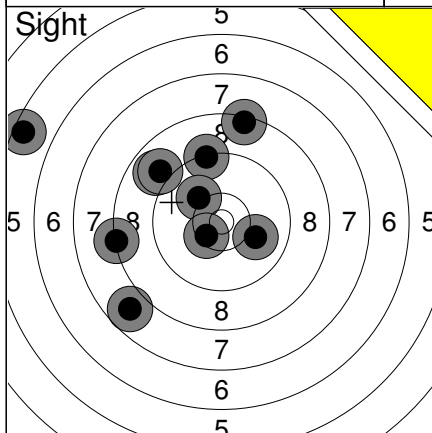

1:	9.3	↑
2:	10.1	↗
3:	10.0	→
4:	8.9	↗
5:	5.5	↖
6:	10.4x	↖
7:	8.4	↑
8:	7.8	↖
9:	8.3	←
10:	8.9	↖
Series	83 (1x)	
	0 (0x)	

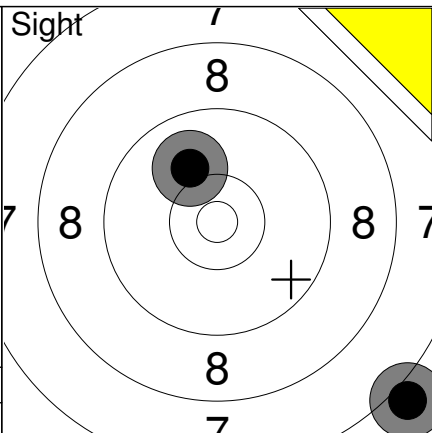

11:	10.0	↖
12:	7.0	↘
Series	17 (0x)	
	0 (0x)	

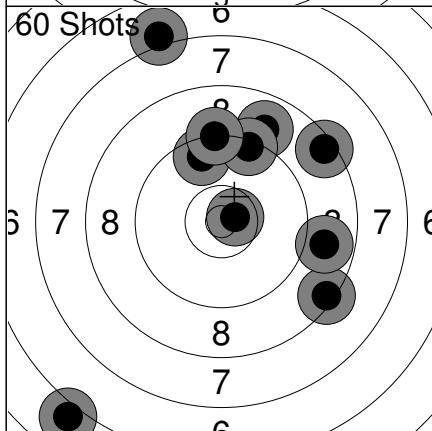

1:	8.9	↑
2:	9.6	↑
3:	9.4	↑
4:	10.7x	→
5:	8.4	↗
6:	7.0	↑
7:	9.2	↑
8:	8.4	↘
9:	6.0	↘
10:	8.8	→
Series	82 (1x)	
	82 (1x)	

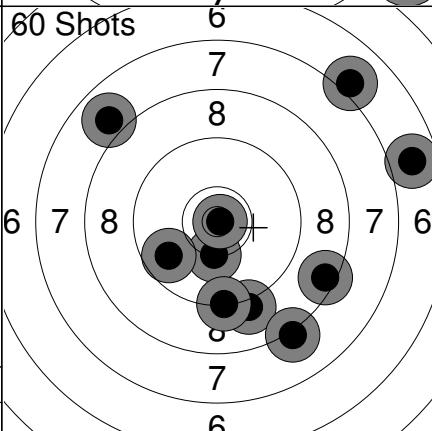

11:	9.1	↘
12:	10.3	↘
13:	6.8	→
14:	8.2	↘
15:	7.9	↗
16:	9.7	↖
17:	10.9x	→
18:	7.0	↗
19:	9.3	↘
20:	8.5	↘
Series	83 (1x)	
	165 (2x)	

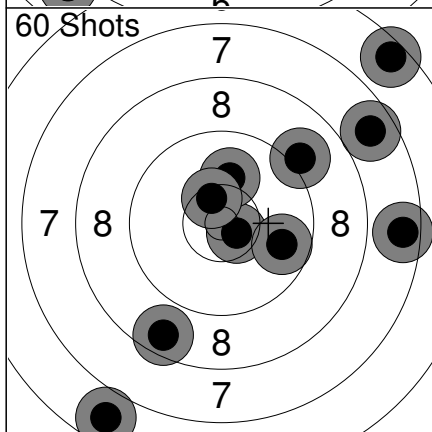

21:	8.6	↘
22:	6.5	↗
23:	10.6x	↘
24:	6.7	↘
25:	7.6	→
26:	9.8	→
27:	7.7	↗
28:	10.1	↑
29:	9.0	↗
30:	10.4x	↑
Series	82 (2x)	
	247 (4x)	

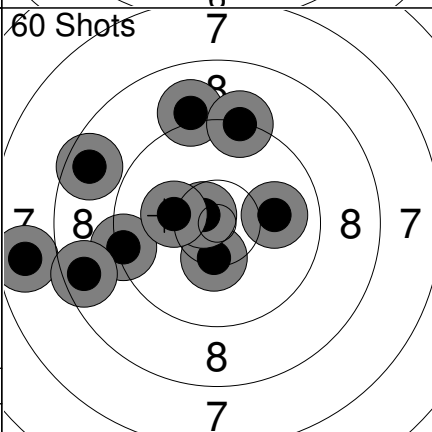

31:	9.1	↑
32:	10.4x	↘
33:	10.0	→
34:	7.7	←
35:	8.6	←
36:	10.7x	↖
37:	9.3	←
38:	9.3	↑
39:	10.2	←
40:	8.6	←
Series	90 (2x)	
	337 (6x)	

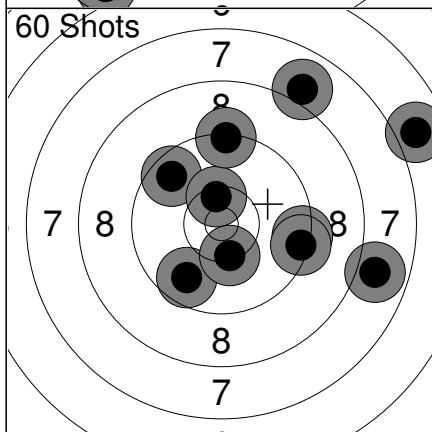

41:	9.6	↖
42:	10.4x	↑
43:	8.0	↑
44:	7.9	→
45:	9.7	↖
46:	6.9	↗
47:	9.4	→
48:	10.3	↘
49:	9.3	↑
50:	9.4	→
Series	86 (1x)	
	423 (7x)	

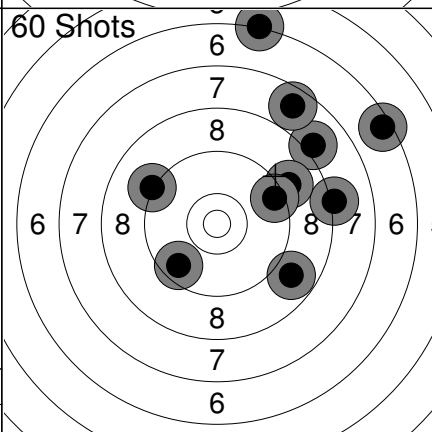

51:	8.1	→
52:	9.6	↘
53:	6.4	↗
54:	9.2	↖
55:	8.0	↗
56:	8.8	↘
57:	9.0	↗
58:	6.2	↑
59:	7.7	↗
60:	9.5	↗
Series	79 (0x)	
	502 (7x)	

Relay **1** Lane **15** **PADDA Kulwinderjit**

2023 SFC Pistol Nationals BC EX MP

15.07.2023 PN23AP-Q-1 Alberta Handgun Association

Comment Signature

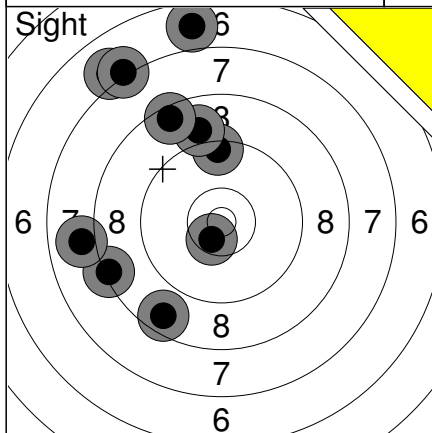

1:	9.4	↑
2:	8.6	↓
3:	7.0	↗
4:	9.0	↑
5:	8.3	←
6:	6.7	↑
7:	10.5x	↓
8:	7.1	↗
9:	8.5	↑
10:	7.9	←
Series	79 (1x)	
	0 (0x)	

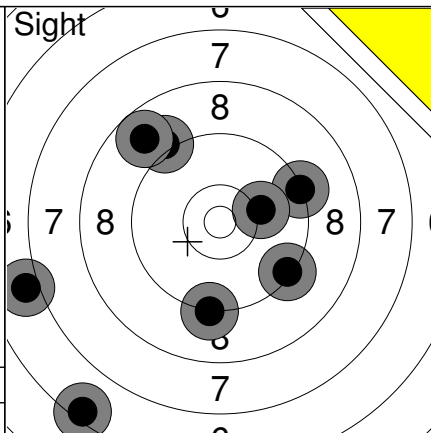

11:	7.0	←
12:	9.3	↗
13:	10.1	→
14:	6.4	↓
15:	9.3	↘
16:	9.1	↗
17:	8.8	↗
18:	9.2	↓
Series	67 (0x)	
	0 (0x)	

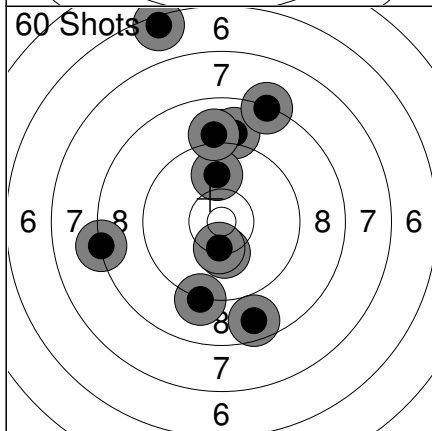

1:	8.7	↓
2:	9.0	↑
3:	8.3	←
4:	9.2	↓
5:	6.4	↑
6:	10.3	↓
7:	9.9	↑
8:	10.4x	↓
9:	8.3	↗
10:	9.0	↑
Series	86 (1x)	
	86 (1x)	

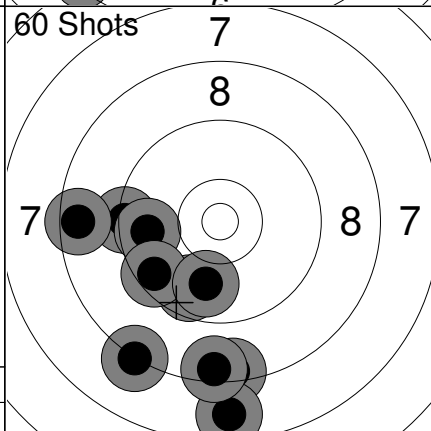

11:	8.4	↓
12:	9.7	↓
13:	7.7	↓
14:	9.3	←
15:	9.7	←
16:	8.5	←
17:	9.5	↙
18:	8.2	↓
19:	8.4	↓
20:	9.9	↓
Series	84 (0x)	
	170 (1x)	

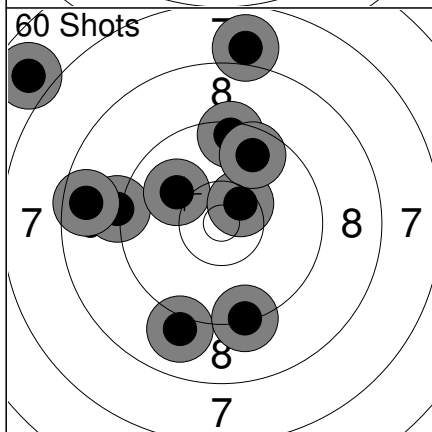

21:	9.2	←
22:	7.9	↑
23:	6.8	↗
24:	10.0	↗
25:	10.5x	↗
26:	9.4	↑
27:	9.0	↓
28:	8.6	←
29:	9.7	↑
30:	9.3	↓
Series	86 (1x)	
	256 (2x)	

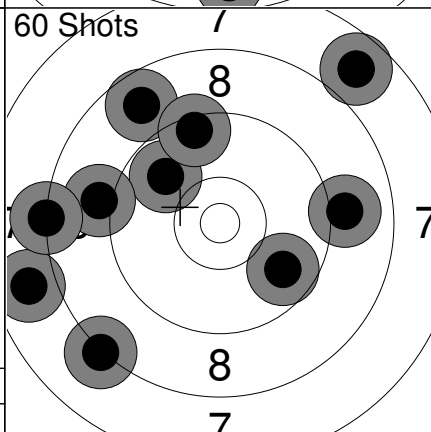

31:	9.8	↗
32:	8.2	↙
33:	9.0	←
34:	8.7	↗
35:	9.0	→
36:	9.7	↘
37:	7.8	←
38:	9.4	↑
39:	8.2	←
40:	7.7	↗
Series	83 (0x)	
	339 (2x)	

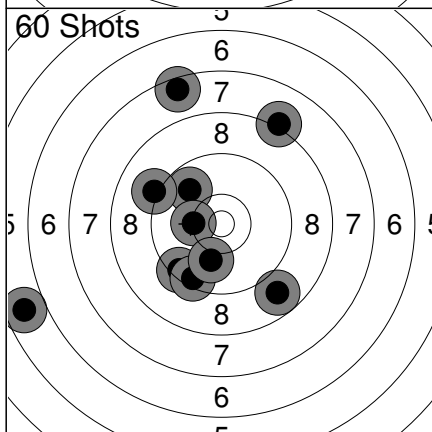

41:	9.4	↙
42:	8.1	↗
43:	9.4	↓
44:	8.8	↓
45:	9.8	↗
46:	5.7	←
47:	10.3	←
48:	7.5	↑
49:	9.1	↖
50:	10.0	↓
Series	84 (0x)	
	423 (2x)	

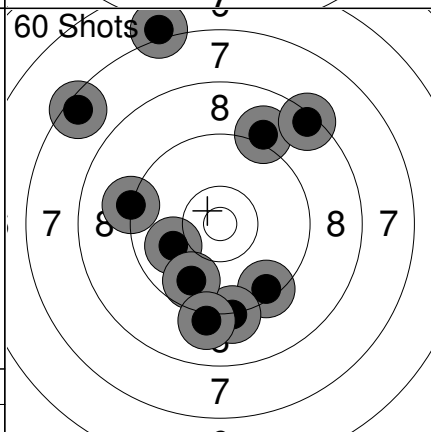

51:	7.1	↑
52:	9.1	↗
53:	8.4	↗
54:	9.2	←
55:	9.4	↓
56:	10.0	←
57:	9.2	↓
58:	9.7	↓
59:	7.5	↖
60:	9.1	↓
Series	86 (0x)	
	509 (2x)	

Relay **1** Lane **16** **KELLY Michael**

2023 SFC Pistol Nationals NS EX MP

15.07.2023 PN23AP-Q-1 Alberta Handgun Association

Comment Signature

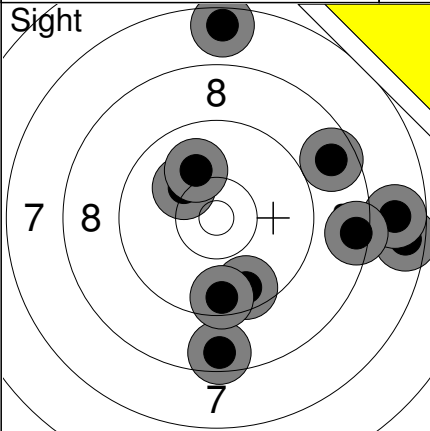
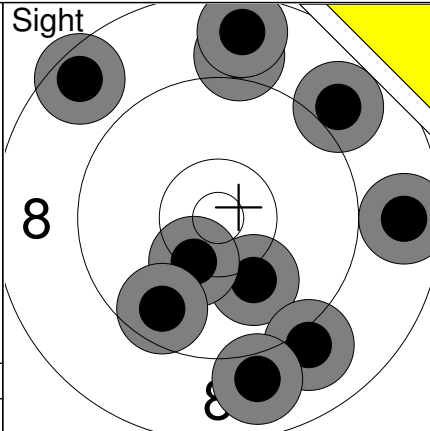
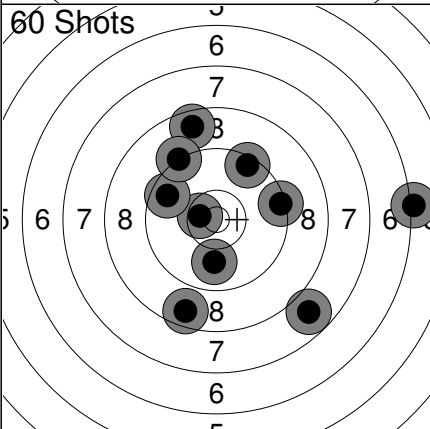
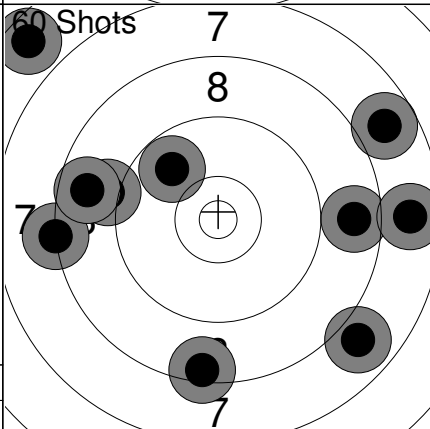
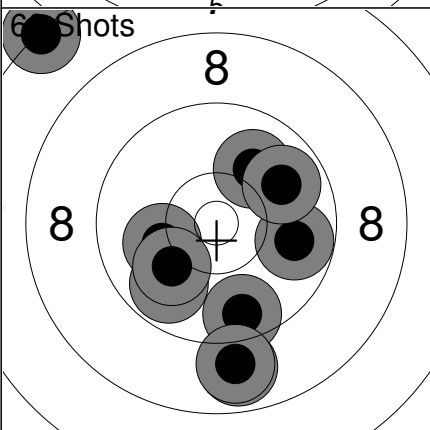
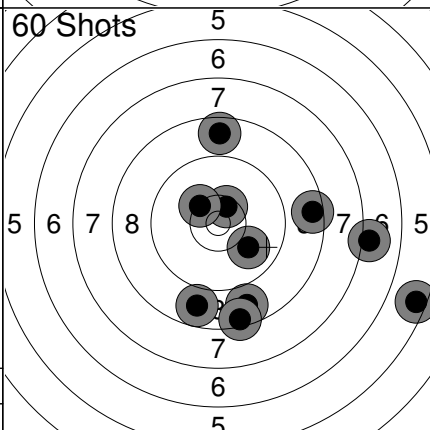
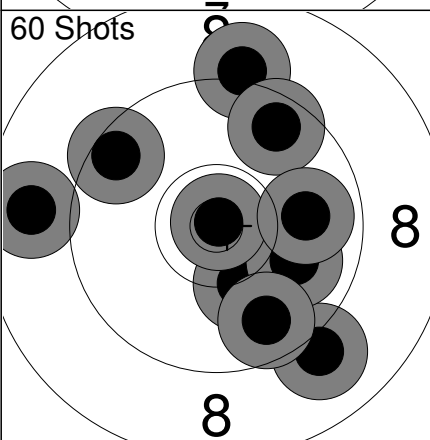
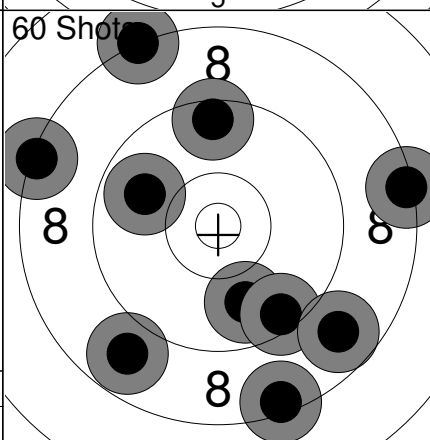
	<p>1: 10.2 ↗ 2: 10.0 ↗ 3: 7.6 → 4: 9.6 ↘ 5: 7.8 → 6: 8.6 ↘ 7: 8.7 → 8: 7.5 ↑ 9: 8.5 → 10: 9.5 ↓</p> <p>Series 83 (0x) 0 (0x)</p>		<p>11: 10.1 ↓ 12: 8.6 ↗ 13: 8.9 ↑ 14: 10.3 ↘ 15: 8.7 ↑ 16: 9.0 ↘ 17: 8.7 → 18: 8.9 ↘ 19: 9.0 ↗ 20: 9.6 ↓</p> <p>Series 87 (0x) 0 (0x)</p>
	<p>1: 9.3 → 2: 8.6 ↗ 3: 7.8 ↘ 4: 9.9 ↘ 5: 10.5x ← 6: 6.1 → 7: 9.6 ↗ 8: 9.4 ↗ 9: 9.2 ↗ 10: 8.6 ↓</p> <p>Series 84 (1x) 84 (1x)</p>		<p>11: 8.7 → 12: 7.9 ↘ 13: 9.1 ← 14: 6.6 ↗ 15: 8.4 ↘ 16: 7.8 ↗ 17: 8.2 ← 18: 7.7 → 19: 8.7 ← 20: 9.8 ↗</p> <p>Series 77 (0x) 161 (1x)</p>
	<p>21: 9.8 → 22: 10.0 ↗ 23: 9.9 → 24: 8.9 ↘ 25: 9.9 ↘ 26: 10.1 ← 27: 9.6 ↘ 28: 8.9 ↘ 29: 7.3 ↗ 30: 10.1 ↘</p> <p>Series 89 (0x) 250 (1x)</p>		<p>31: 10.0 ↘ 32: 8.6 ↑ 33: 8.5 → 34: 8.7 ↘ 35: 10.5x ↗ 36: 7.0 → 37: 8.8 ↘ 38: 8.4 ↘ 39: 10.3 ↗ 40: 5.5 →</p> <p>Series 82 (1x) 332 (2x)</p>
	<p>41: 10.2 ↓ 42: 9.1 ↑ 43: 9.6 ↗ 44: 9.0 ↘ 45: 9.9 ↘ 46: 9.7 ↘ 47: 9.5 ↗ 48: 10.9x ↗ 49: 9.9 → 50: 8.8 ←</p> <p>Series 91 (1x) 423 (3x)</p>		<p>51: 9.8 ↓ 52: 8.2 ↗ 53: 8.3 ↗ 54: 8.3 → 55: 9.5 ↘ 56: 8.8 ↘ 57: 9.9 ↗ 58: 9.5 ↑ 59: 8.4 ↘ 60: 8.8 ↘</p> <p>Series 84 (0x) 507 (3x)</p>

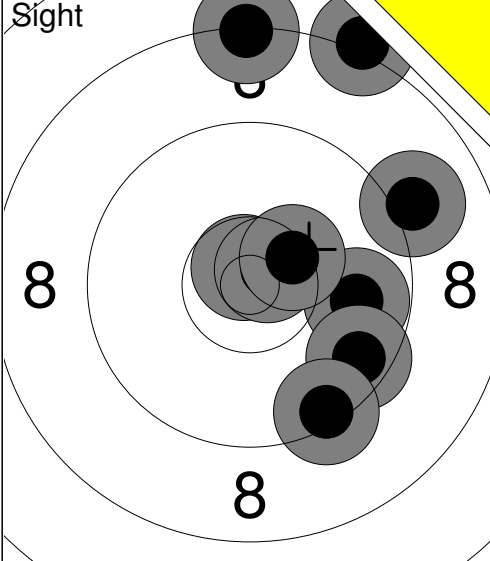
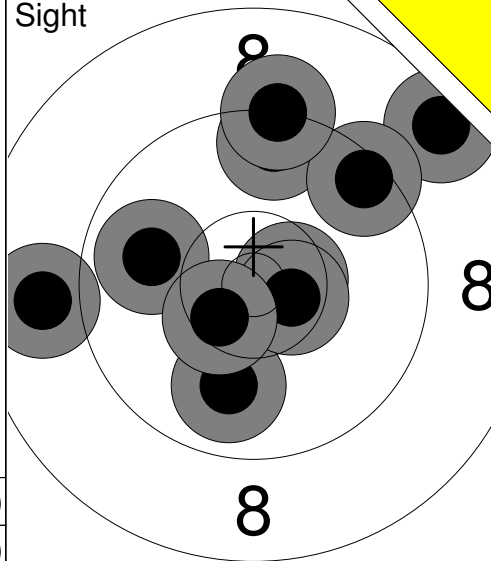
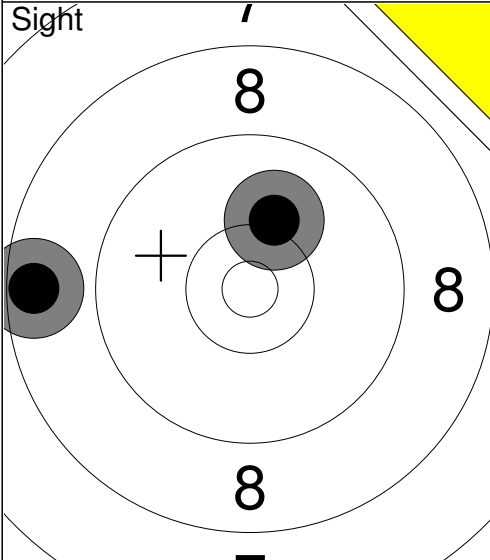
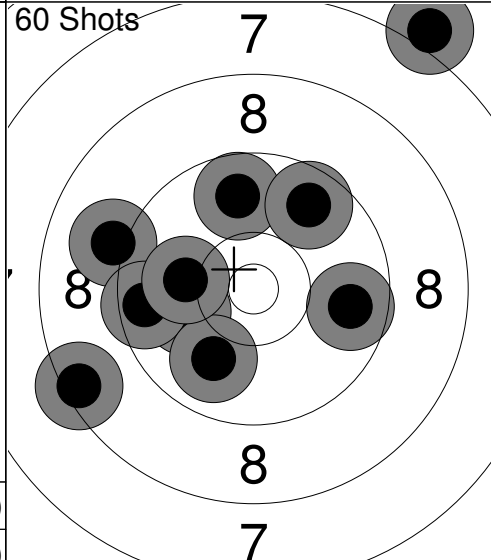
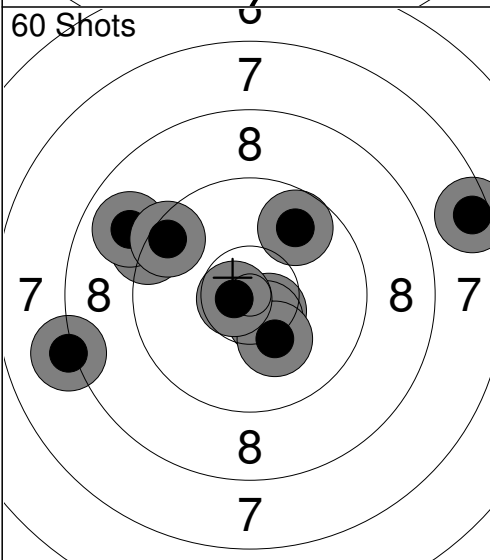
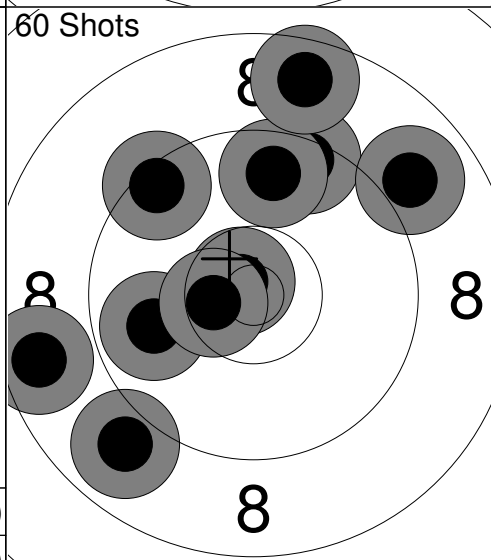
<p>Sight</p>  <p style="text-align: center;">8</p>	<p>1: 8.3 ↑</p> <p>2: 9.0 →</p> <p>3: 10.8x ↑</p> <p>5: 8.1 ↑</p> <p>6: 9.8 →</p> <p>7: 10.7x →</p> <p>8: 9.6 →</p> <p>9: 9.4 ↓</p> <p>10: 10.4x →</p> <hr/> <p>Series 82 (3x)</p> <p style="text-align: center;">0 (0x)</p>	<p>Sight</p>  <p style="text-align: center;">8</p>	<p>11: 9.9 ↓</p> <p>12: 8.5 →</p> <p>13: 9.5 ↑</p> <p>14: 10.6x →</p> <p>15: 9.4 →</p> <p>16: 10.6x →</p> <p>17: 8.9 ←</p> <p>18: 9.9 ←</p> <p>19: 10.5x ↙</p> <p>20: 9.2 ↑</p> <hr/> <p>Series 91 (3x)</p> <p style="text-align: center;">0 (0x)</p>
<p>Sight</p>  <p style="text-align: center;">8</p>	<p>21: 8.5 ←</p> <p>22: 10.1 ↑</p> <hr/> <p>Series 18 (0x)</p> <p style="text-align: center;">0 (0x)</p>	<p>60 Shots</p>  <p style="text-align: center;">8</p>	<p>1: 9.1 ←</p> <p>2: 10.1 ←</p> <p>3: 9.8 ↑</p> <p>4: 7.0 →</p> <p>5: 9.6 ←</p> <p>6: 9.9 ↓</p> <p>7: 9.7 →</p> <p>8: 9.7 ↑</p> <p>9: 10.1 ←</p> <p>10: 8.4 ←</p> <hr/> <p>Series 89 (0x)</p> <p style="text-align: center;">89 (0x)</p>
<p>60 Shots</p>  <p style="text-align: center;">8</p>	<p>11: 9.3 ←</p> <p>12: 10.6x ↘</p> <p>13: 8.2 ←</p> <p>14: 10.5x ↘</p> <p>15: 7.5 →</p> <p>16: 8.9 ←</p> <p>17: 10.2 ↓</p> <p>18: 9.5 →</p> <p>19: 9.8 ↑</p> <p>20: 10.7x ←</p> <hr/> <p>Series 90 (3x)</p> <p style="text-align: center;">179 (3x)</p>	<p>60 Shots</p>  <p style="text-align: center;">8</p>	<p>21: 9.4 ↑</p> <p>22: 10.8x ↖</p> <p>23: 8.9 →</p> <p>24: 9.9 ←</p> <p>25: 9.7 ↑</p> <p>26: 9.4 ↖</p> <p>27: 10.5x ←</p> <p>28: 8.6 ←</p> <p>29: 8.9 ↙</p> <p>30: 8.6 ↑</p> <hr/> <p>Series 88 (2x)</p> <p style="text-align: center;">267 (5x)</p>

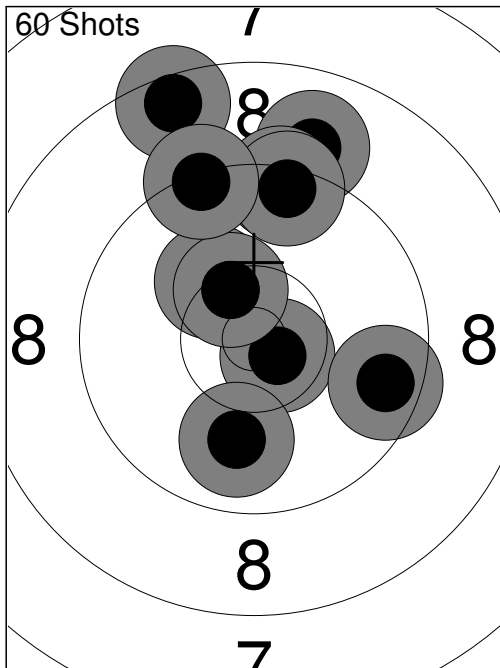

31:	10.3	↖
32:	10.7x	↘
33:	10.4x	↖
34:	9.6	→
35:	9.0	↑
36:	8.5	↑
37:	9.9	↓
38:	9.4	↑
39:	9.4	↑
40:	9.3	↑
Series	92 (2x)	
	359 (7x)	

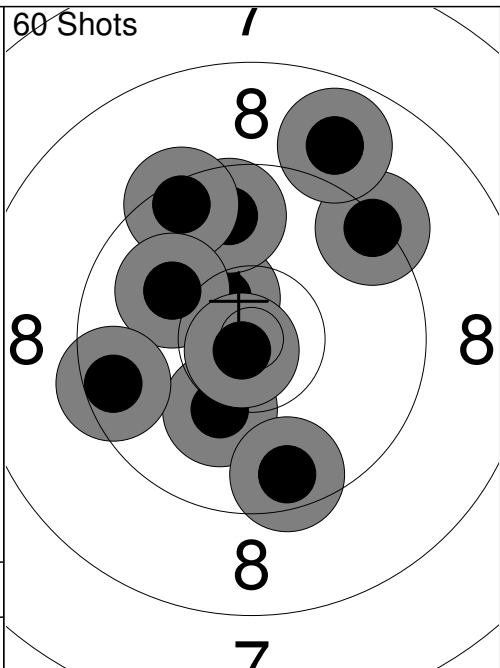

41:	10.5x	↖
42:	9.3	↗
43:	8.9	↑
44:	9.7	↑
45:	9.5	↖
46:	10.2	↘
47:	9.6	↓
48:	10.0	↖
49:	10.8x	↘
50:	9.5	←
Series	93 (2x)	
	452 (9x)	

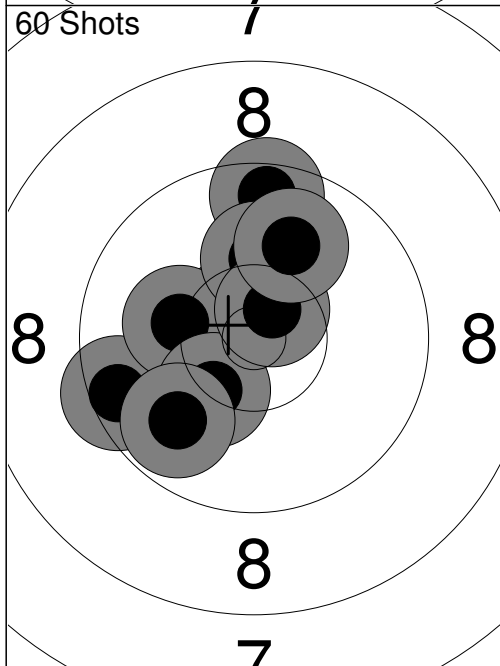

51:	10.6x	↖
52:	9.5	←
53:	9.5	↑
54:	10.4	←
55:	10.2	←
56:	10.3	↘
57:	10.2	↑
58:	10.6x	↗
59:	9.8	↘
60:	10.0	↑
Series	97 (2x)	
	549 (11x)	

Relay 1	Lane 18	OLSEN Jesse
-------------------	-------------------	--------------------

2023 SFC Pistol Nationals	SK	EX	MP
---------------------------	----	----	----

15.07.2023	PN23AP-Q-1	Alberta Handgun Association
------------	------------	-----------------------------

Comment	Signature
---------	-----------

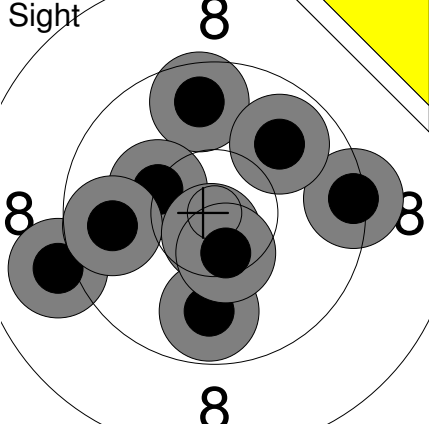
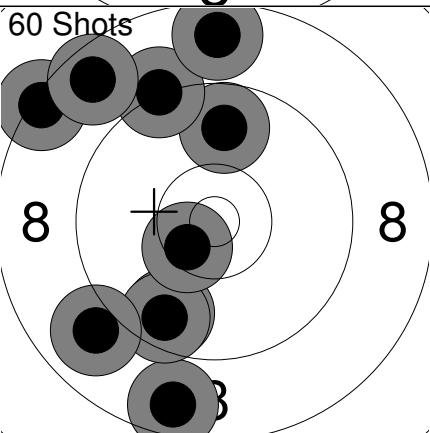
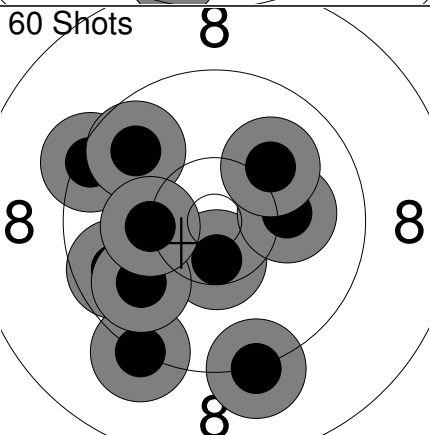
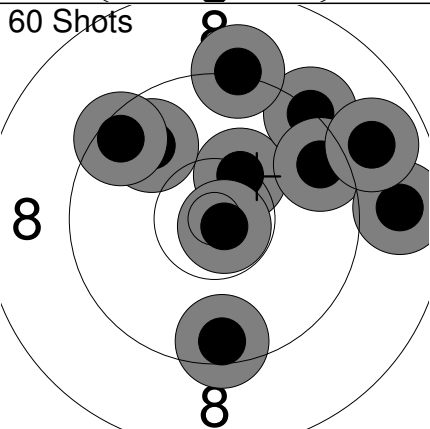
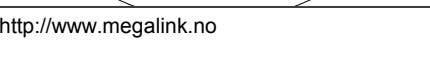
<p>Sight</p> 	<table border="1" style="width:100%; border-collapse: collapse;"> <tr><td>1:</td><td>9.7</td><td>↑</td></tr> <tr><td>2:</td><td>9.1</td><td>←</td></tr> <tr><td>3:</td><td>10.3</td><td>↖</td></tr> <tr><td>4:</td><td>9.8</td><td>←</td></tr> <tr><td>5:</td><td>10.7x</td><td>↓</td></tr> <tr><td>6:</td><td>9.8</td><td>↓</td></tr> <tr><td>7:</td><td>9.4</td><td>→</td></tr> <tr><td>8:</td><td>9.9</td><td>↗</td></tr> <tr><td>9:</td><td>10.5x</td><td>↓</td></tr> <tr><td colspan="2">Series</td><td>84 (2x)</td></tr> <tr><td colspan="2"></td><td>0 (0x)</td></tr> </table>	1:	9.7	↑	2:	9.1	←	3:	10.3	↖	4:	9.8	←	5:	10.7x	↓	6:	9.8	↓	7:	9.4	→	8:	9.9	↗	9:	10.5x	↓	Series		84 (2x)			0 (0x)	<p>60 Shots</p> 	<table border="1" style="width:100%; border-collapse: collapse;"> <tr><td>1:</td><td>9.4</td><td>↑</td></tr> <tr><td>2:</td><td>10.3</td><td>→</td></tr> <tr><td>3:</td><td>9.8</td><td>↓</td></tr> <tr><td>4:</td><td>10.1</td><td>↑</td></tr> <tr><td>5:</td><td>9.0</td><td>↑</td></tr> <tr><td>6:</td><td>8.7</td><td>↗</td></tr> <tr><td>7:</td><td>9.9</td><td>↙</td></tr> <tr><td>8:</td><td>10.7x</td><td>↓</td></tr> <tr><td>9:</td><td>10.6x</td><td>↓</td></tr> <tr><td>10:</td><td>9.1</td><td>↗</td></tr> <tr><td colspan="2">Series</td><td>93 (2x)</td></tr> <tr><td colspan="2"></td><td>93 (2x)</td></tr> </table>	1:	9.4	↑	2:	10.3	→	3:	9.8	↓	4:	10.1	↑	5:	9.0	↑	6:	8.7	↗	7:	9.9	↙	8:	10.7x	↓	9:	10.6x	↓	10:	9.1	↗	Series		93 (2x)			93 (2x)			
1:	9.7	↑																																																																									
2:	9.1	←																																																																									
3:	10.3	↖																																																																									
4:	9.8	←																																																																									
5:	10.7x	↓																																																																									
6:	9.8	↓																																																																									
7:	9.4	→																																																																									
8:	9.9	↗																																																																									
9:	10.5x	↓																																																																									
Series		84 (2x)																																																																									
		0 (0x)																																																																									
1:	9.4	↑																																																																									
2:	10.3	→																																																																									
3:	9.8	↓																																																																									
4:	10.1	↑																																																																									
5:	9.0	↑																																																																									
6:	8.7	↗																																																																									
7:	9.9	↙																																																																									
8:	10.7x	↓																																																																									
9:	10.6x	↓																																																																									
10:	9.1	↗																																																																									
Series		93 (2x)																																																																									
		93 (2x)																																																																									
<p>60 Shots</p> 	<table border="1" style="width:100%; border-collapse: collapse;"> <tr><td>11:</td><td>9.8</td><td>↑</td></tr> <tr><td>12:</td><td>9.7</td><td>↓</td></tr> <tr><td>13:</td><td>8.6</td><td>↓</td></tr> <tr><td>14:</td><td>8.4</td><td>↖</td></tr> <tr><td>15:</td><td>9.2</td><td>↗</td></tr> <tr><td>16:</td><td>8.6</td><td>↗</td></tr> <tr><td>17:</td><td>8.6</td><td>↑</td></tr> <tr><td>18:</td><td>9.6</td><td>↓</td></tr> <tr><td>19:</td><td>10.5x</td><td>↙</td></tr> <tr><td>20:</td><td>8.9</td><td>↙</td></tr> <tr><td colspan="2">Series</td><td>86 (1x)</td></tr> <tr><td colspan="2"></td><td>179 (3x)</td></tr> </table>	11:	9.8	↑	12:	9.7	↓	13:	8.6	↓	14:	8.4	↖	15:	9.2	↗	16:	8.6	↗	17:	8.6	↑	18:	9.6	↓	19:	10.5x	↙	20:	8.9	↙	Series		86 (1x)			179 (3x)	<p>60 Shots</p> 	<table border="1" style="width:100%; border-collapse: collapse;"> <tr><td>21:</td><td>10.1</td><td>→</td></tr> <tr><td>22:</td><td>9.1</td><td>←</td></tr> <tr><td>23:</td><td>9.3</td><td>↑</td></tr> <tr><td>24:</td><td>10.1</td><td>←</td></tr> <tr><td>25:</td><td>10.7x</td><td>↑</td></tr> <tr><td>26:</td><td>9.6</td><td>↙</td></tr> <tr><td>27:</td><td>10.3</td><td>→</td></tr> <tr><td>28:</td><td>9.6</td><td>↓</td></tr> <tr><td>29:</td><td>10.4x</td><td>↑</td></tr> <tr><td>30:</td><td>9.1</td><td>→</td></tr> <tr><td colspan="2">Series</td><td>95 (2x)</td></tr> <tr><td colspan="2"></td><td>274 (5x)</td></tr> </table>	21:	10.1	→	22:	9.1	←	23:	9.3	↑	24:	10.1	←	25:	10.7x	↑	26:	9.6	↙	27:	10.3	→	28:	9.6	↓	29:	10.4x	↑	30:	9.1	→	Series		95 (2x)			274 (5x)
11:	9.8	↑																																																																									
12:	9.7	↓																																																																									
13:	8.6	↓																																																																									
14:	8.4	↖																																																																									
15:	9.2	↗																																																																									
16:	8.6	↗																																																																									
17:	8.6	↑																																																																									
18:	9.6	↓																																																																									
19:	10.5x	↙																																																																									
20:	8.9	↙																																																																									
Series		86 (1x)																																																																									
		179 (3x)																																																																									
21:	10.1	→																																																																									
22:	9.1	←																																																																									
23:	9.3	↑																																																																									
24:	10.1	←																																																																									
25:	10.7x	↑																																																																									
26:	9.6	↙																																																																									
27:	10.3	→																																																																									
28:	9.6	↓																																																																									
29:	10.4x	↑																																																																									
30:	9.1	→																																																																									
Series		95 (2x)																																																																									
		274 (5x)																																																																									
<p>60 Shots</p> 	<table border="1" style="width:100%; border-collapse: collapse;"> <tr><td>31:</td><td>9.4</td><td>←</td></tr> <tr><td>32:</td><td>9.8</td><td>↗</td></tr> <tr><td>33:</td><td>9.2</td><td>↓</td></tr> <tr><td>34:</td><td>10.5x</td><td>↓</td></tr> <tr><td>35:</td><td>9.7</td><td>←</td></tr> <tr><td>36:</td><td>9.2</td><td>↓</td></tr> <tr><td>37:</td><td>9.9</td><td>↙</td></tr> <tr><td>38:</td><td>10.2</td><td>←</td></tr> <tr><td>39:</td><td>10.1</td><td>→</td></tr> <tr><td>40:</td><td>10.1</td><td>↗</td></tr> <tr><td colspan="2">Series</td><td>94 (1x)</td></tr> <tr><td colspan="2"></td><td>368 (6x)</td></tr> </table>	31:	9.4	←	32:	9.8	↗	33:	9.2	↓	34:	10.5x	↓	35:	9.7	←	36:	9.2	↓	37:	9.9	↙	38:	10.2	←	39:	10.1	→	40:	10.1	↗	Series		94 (1x)			368 (6x)	<p>60 Shots</p>	<table border="1" style="width:100%; border-collapse: collapse;"> <tr><td>41:</td><td>9.9</td><td>↑</td></tr> <tr><td>42:</td><td>10.4x</td><td>↑</td></tr> <tr><td>43:</td><td>10.1</td><td>←</td></tr> <tr><td>44:</td><td>9.4</td><td>→</td></tr> <tr><td>45:</td><td>8.7</td><td>→</td></tr> <tr><td>46:</td><td>9.2</td><td>→</td></tr> <tr><td>47:</td><td>10.2</td><td>↙</td></tr> <tr><td>48:</td><td>9.9</td><td>←</td></tr> <tr><td>49:</td><td>10.2</td><td>↗</td></tr> <tr><td>50:</td><td>10.0</td><td>↓</td></tr> <tr><td colspan="2">Series</td><td>94 (1x)</td></tr> <tr><td colspan="2"></td><td>462 (7x)</td></tr> </table>	41:	9.9	↑	42:	10.4x	↑	43:	10.1	←	44:	9.4	→	45:	8.7	→	46:	9.2	→	47:	10.2	↙	48:	9.9	←	49:	10.2	↗	50:	10.0	↓	Series		94 (1x)			462 (7x)
31:	9.4	←																																																																									
32:	9.8	↗																																																																									
33:	9.2	↓																																																																									
34:	10.5x	↓																																																																									
35:	9.7	←																																																																									
36:	9.2	↓																																																																									
37:	9.9	↙																																																																									
38:	10.2	←																																																																									
39:	10.1	→																																																																									
40:	10.1	↗																																																																									
Series		94 (1x)																																																																									
		368 (6x)																																																																									
41:	9.9	↑																																																																									
42:	10.4x	↑																																																																									
43:	10.1	←																																																																									
44:	9.4	→																																																																									
45:	8.7	→																																																																									
46:	9.2	→																																																																									
47:	10.2	↙																																																																									
48:	9.9	←																																																																									
49:	10.2	↗																																																																									
50:	10.0	↓																																																																									
Series		94 (1x)																																																																									
		462 (7x)																																																																									
<p>60 Shots</p>	<table border="1" style="width:100%; border-collapse: collapse;"> <tr><td>51:</td><td>9.5</td><td>↓</td></tr> <tr><td>52:</td><td>10.3</td><td>↗</td></tr> <tr><td>53:</td><td>9.3</td><td>↗</td></tr> <tr><td>54:</td><td>9.8</td><td>↗</td></tr> <tr><td>55:</td><td>9.5</td><td>→</td></tr> <tr><td>56:</td><td>9.2</td><td>↑</td></tr> <tr><td>57:</td><td>9.5</td><td>↗</td></tr> <tr><td>58:</td><td>8.8</td><td>→</td></tr> <tr><td>59:</td><td>8.9</td><td>→</td></tr> <tr><td>60:</td><td>10.8x</td><td>↓</td></tr> <tr><td colspan="2">Series</td><td>90 (1x)</td></tr> <tr><td colspan="2"></td><td>552 (8x)</td></tr> </table>	51:	9.5	↓	52:	10.3	↗	53:	9.3	↗	54:	9.8	↗	55:	9.5	→	56:	9.2	↑	57:	9.5	↗	58:	8.8	→	59:	8.9	→	60:	10.8x	↓	Series		90 (1x)			552 (8x)																																						
51:	9.5	↓																																																																									
52:	10.3	↗																																																																									
53:	9.3	↗																																																																									
54:	9.8	↗																																																																									
55:	9.5	→																																																																									
56:	9.2	↑																																																																									
57:	9.5	↗																																																																									
58:	8.8	→																																																																									
59:	8.9	→																																																																									
60:	10.8x	↓																																																																									
Series		90 (1x)																																																																									
		552 (8x)																																																																									

Relay **1** Lane **19** **LE SIEUR Francis**

2023 SFC Pistol Nationals QC EX MP

15.07.2023 PN23AP-Q-1 Alberta Handgun Association

Comment Signature

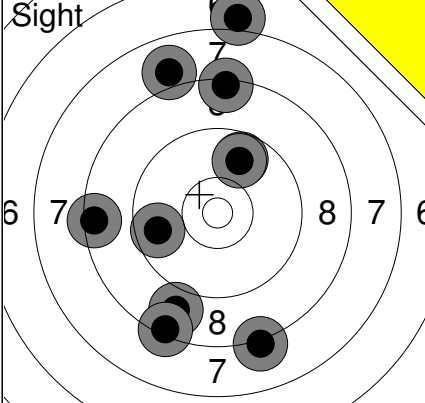
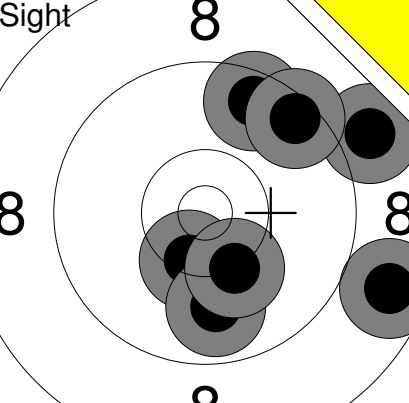
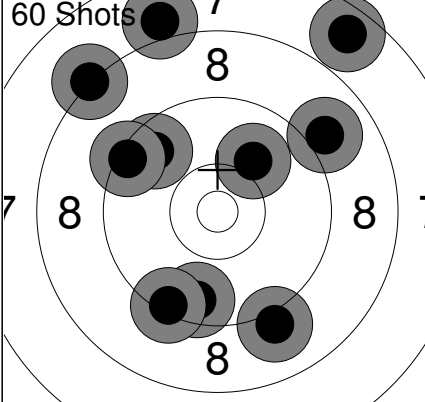
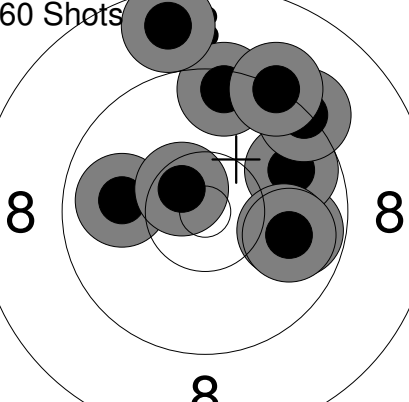
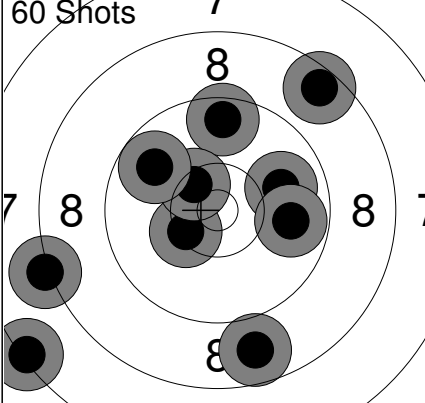
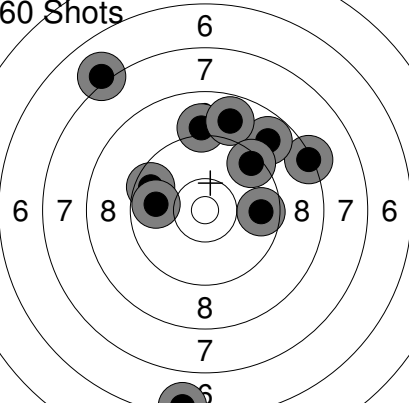
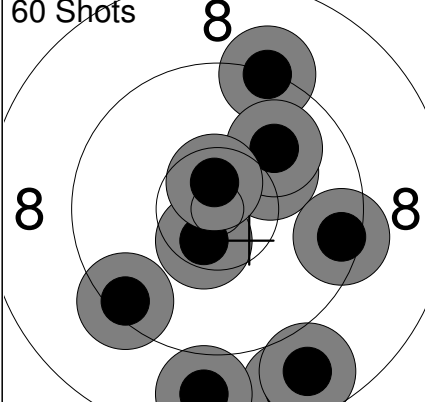
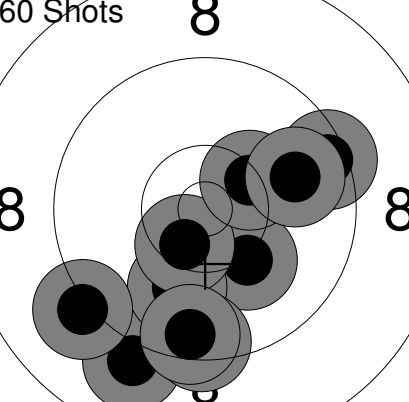
	<p>1: 8.8 ↓ 2: 9.8 ↑ 3: 7.0 ↑ 4: 8.4 ↓ 5: 8.4 ↑ 6: 9.7 ← 7: 9.8 ↑ 8: 8.4 ← 9: 7.9 ↑ 10: 8.2 ↓</p> <p>Series 81 (0x) 0 (0x)</p>		<p>11: 8.9 → 12: 10.4x ↓ 13: 9.6 ↑ 14: 9.9 ↓ 15: 9.5 → 16: 8.7 → 17: 10.2 ↓</p> <p>Series 63 (1x) 0 (0x)</p>
	<p>1: 7.6 ↑ 2: 9.6 ↑ 3: 9.6 ↓ 4: 8.0 ↑ 5: 8.2 ↑ 6: 9.4 ↓ 7: 9.0 ↓ 8: 9.0 → 9: 9.4 ← 10: 10.0 ↑</p> <p>Series 87 (0x) 87 (0x)</p>		<p>11: 9.8 → 12: 9.5 ↑ 13: 8.7 ↑ 14: 9.8 → 15: 9.3 → 16: 9.9 ← 17: 9.2 ↑ 18: 10.6x ↑ 19: 10.0 → 20: 9.9 →</p> <p>Series 91 (1x) 178 (1x)</p>
	<p>21: 7.3 ← 22: 9.6 ↑ 23: 10.4x ← 24: 8.7 ↓ 25: 9.9 → 26: 10.4x ↑ 27: 8.5 ↑ 28: 9.8 ↑ 29: 9.8 → 30: 8.2 ←</p> <p>Series 87 (2x) 265 (3x)</p>		<p>31: 8.3 → 32: 6.4 ↓ 33: 7.1 ↑ 34: 9.1 ↑ 35: 9.6 ← 36: 9.7 → 37: 8.8 → 38: 9.8 ← 39: 8.8 ↑ 40: 9.4 →</p> <p>Series 82 (0x) 347 (3x)</p>
	<p>41: 9.4 ← 42: 9.3 ↑ 43: 10.2 → 44: 9.4 → 45: 10.0 ↑ 46: 8.7 ↓ 47: 10.5x ↓ 48: 8.8 ↓ 49: 10.6x ↑ 50: 8.8 ↓</p> <p>Series 91 (2x) 438 (5x)</p>		<p>51: 10.2 ↓ 52: 9.0 ↓ 53: 10.0 ↓ 54: 9.1 ← 55: 10.5x ↓ 56: 9.4 ↓ 57: 9.5 ↓ 58: 10.3 → 59: 9.4 → 60: 9.9 →</p> <p>Series 94 (1x) 532 (6x)</p>

Relay **1** Lane **20** **MARKEWICZ Alan**

2023 SFC Pistol Nationals AB EX MP

15.07.2023 PN23AP-Q-1 Alberta Handgun Association

Comment Signature

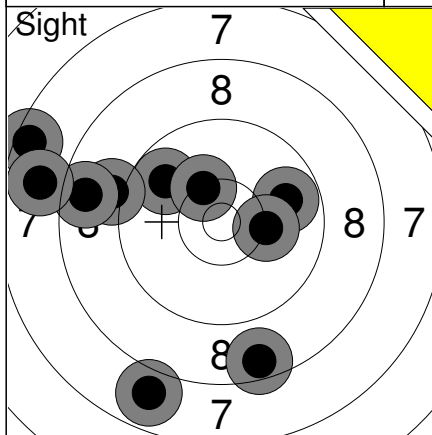

1:	8.5	↓
2:	7.8	↓
3:	9.8	↗
4:	9.8	→
5:	7.5	↗
6:	10.3	↗
7:	9.1	↖
8:	10.2	→
9:	8.6	↖
10:	7.8	↖
Series	84 (0x)	
	0 (0x)	

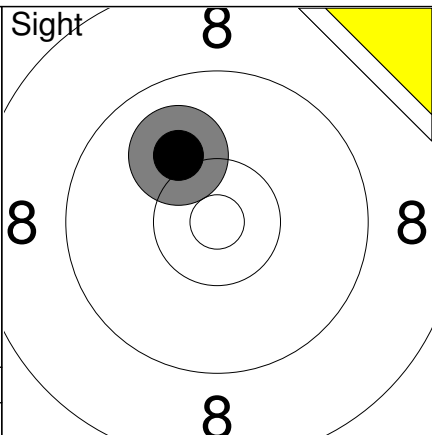

11:	10.1	↗
Series	10 (0x)	
	0 (0x)	

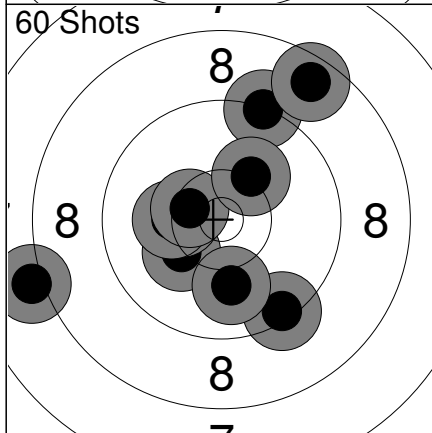

1:	10.2	↖
2:	10.4x	↖
3:	10.2	↖
4:	10.5x	↖
5:	9.4	↓
6:	9.3	↗
7:	8.6	↗
8:	10.2	↗
9:	10.0	↓
10:	8.1	↖
Series	94 (2x)	
	94 (2x)	

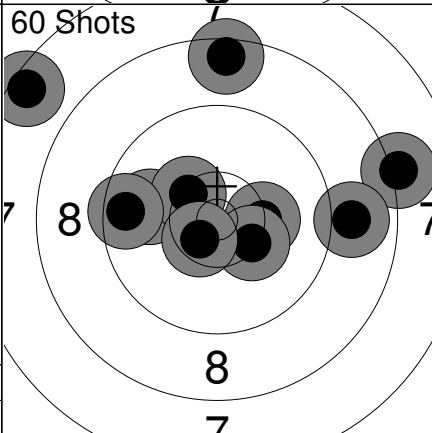

11:	9.9	↖
12:	10.4x	↗
13:	10.3	→
14:	8.1	→
15:	10.3	↓
16:	9.6	↖
17:	7.5	↗
18:	8.9	→
19:	8.5	↑
20:	10.6x	↙
Series	89 (2x)	
	183 (4x)	

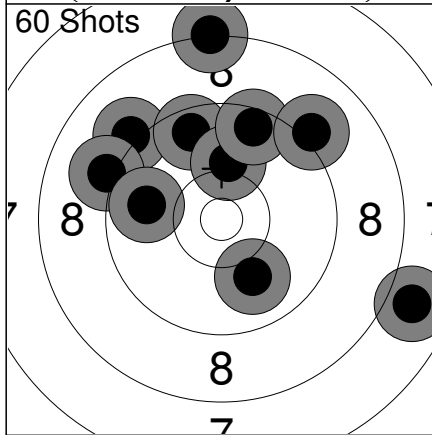

21:	7.9	→
22:	10.0	↓
23:	8.2	↑
24:	9.1	↗
25:	9.6	↗
26:	9.1	↖
27:	10.1	↑
28:	9.5	↑
29:	9.8	↖
30:	9.1	↗
Series	89 (0x)	
	272 (4x)	

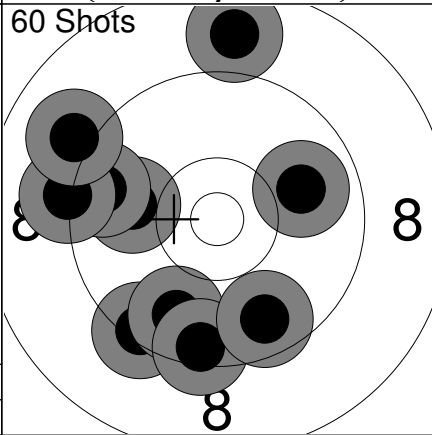

31:	9.9	↖
32:	9.4	↙
33:	8.8	↑
34:	9.7	↓
35:	9.4	↓
36:	9.6	↖
37:	9.2	↖
38:	9.7	↓
39:	9.0	↗
40:	9.9	→
Series	89 (0x)	
	361 (4x)	

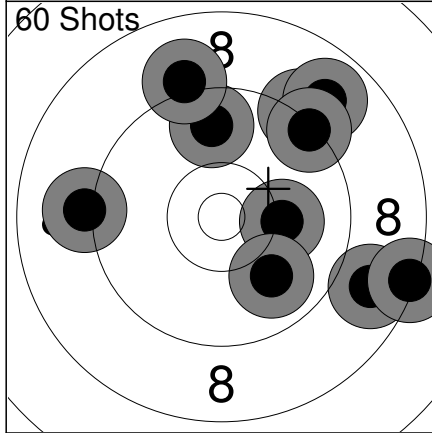

41:	10.1	→
42:	9.9	↓
43:	9.2	↗
44:	8.8	→
45:	9.7	↑
46:	8.9	↗
47:	9.1	↖
48:	8.3	→
49:	9.3	↗
50:	9.1	↑
Series	88 (0x)	
	449 (4x)	

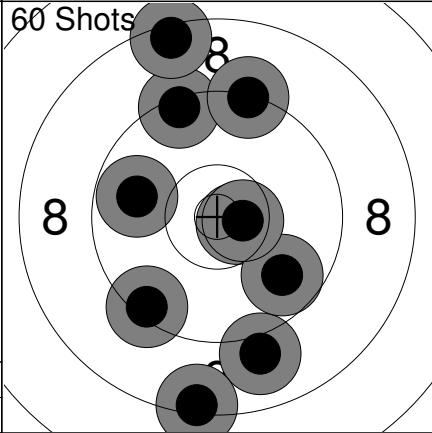

51:	9.8	↖
52:	10.7x	→
53:	9.0	↓
54:	9.4	↗
55:	9.8	↓
56:	8.4	↑
57:	10.6x	→
58:	9.4	↙
59:	8.3	↓
60:	9.3	↑
Series	90 (2x)	
	539 (6x)	

Relay 1	Lane 21	OZER Tugrul
-------------------	-------------------	--------------------

2023 SFC Pistol Nationals	AB	MA	MP
---------------------------	----	----	----

15.07.2023	PN23AP-Q-1	Alberta Handgun Association
------------	------------	-----------------------------

Comment	Signature
---------	-----------

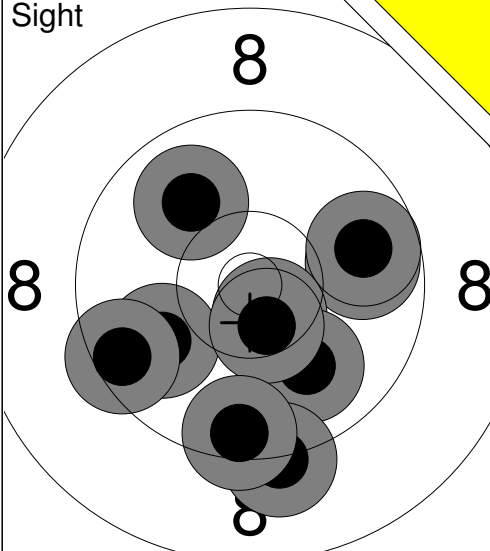
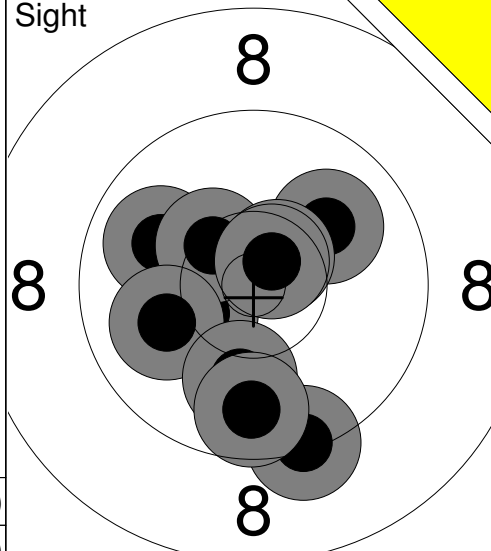
<p>Sight</p> 	<p>1: 9.8 → 2: 10.0 ↗ 3: 9.9 ← 4: 10.6x ↓ 5: 10.0 ↓ 6: 9.8 → 7: 9.5 ← 8: 10.5x ↓ 9: 9.2 ↓ 10: 9.5 ↓</p> <p>Series 94 (2x) 0 (0x)</p>	<p>Sight</p> 	<p>11: 9.9 ← 12: 10.4x ↙ 13: 9.3 ↓ 14: 10.4x ↖ 15: 10.0 ↗ 16: 10.0 ← 17: 10.0 ↓ 18: 9.7 ↓ 19: 10.6x ↗ 20: 10.7x ↗</p> <p>Series 97 (4x) 0 (0x)</p>
---	--	---	--

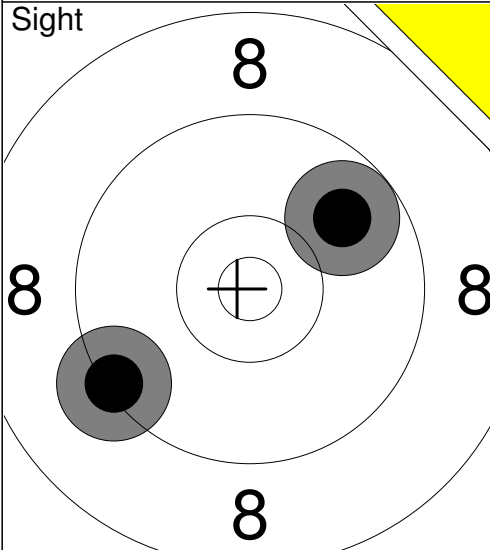
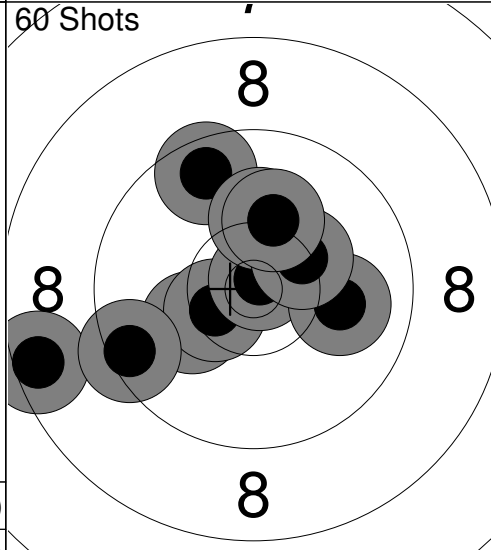
<p>Sight</p> 	<p>21: 9.3 ← 22: 9.8 →</p> <p>Series 18 (0x) 0 (0x)</p>	<p>60 Shots</p> 	<p>1: 10.2 ← 2: 10.5x ↙ 3: 9.6 ↗ 4: 10.8x ↗ 5: 8.5 ← 6: 10.2 ↑ 7: 9.5 ← 8: 10.0 → 9: 10.3 ↗ 10: 10.2 ↑</p> <p>Series 96 (2x) 96 (2x)</p>
--	---	---	--

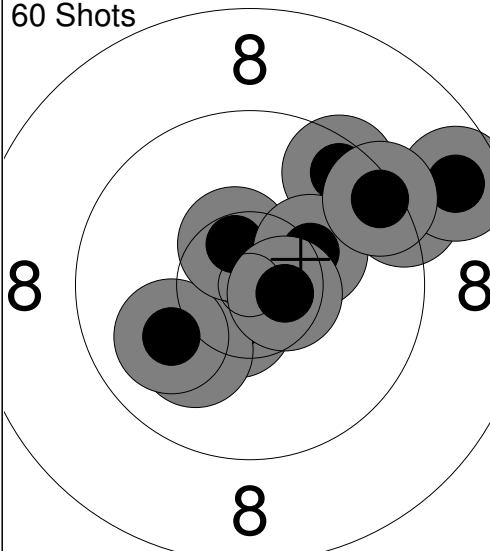
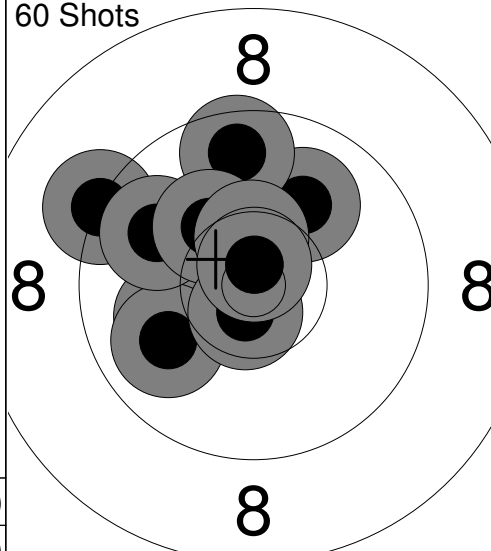
<p>60 Shots</p> 	<p>11: 10.6x ↓ 12: 9.3 → 13: 10.1 ↓ 14: 10.0 ← 15: 9.5 ↗ 16: 8.7 → 17: 10.5x ↗ 18: 10.3 → 19: 10.6x → 20: 9.4 →</p> <p>Series 95 (3x) 191 (5x)</p>	<p>60 Shots</p> 	<p>21: 10.0 ↗ 22: 10.1 ← 23: 9.9 ← 24: 9.3 ↙ 25: 9.6 ↑ 26: 9.9 ↙ 27: 10.2 ↖ 28: 10.5x ↑ 29: 10.7x ↓ 30: 10.7x ↑</p> <p>Series 96 (3x) 287 (8x)</p>
--	--	--	--

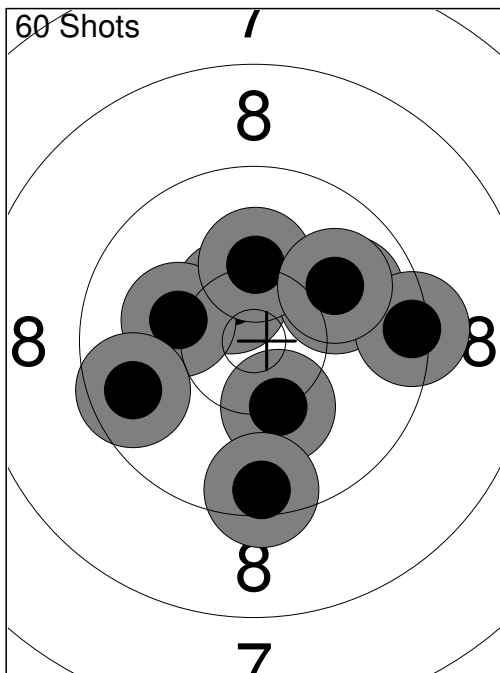

31:	10.3	↘
32:	9.9	↗
33:	10.5x	↖
34:	10.2	←
35:	9.7	←
36:	10.0	↗
37:	10.2	↑
38:	9.4	→
39:	9.5	↓
40:	10.0	↗
Series	96 (1x)	
	383 (9x)	

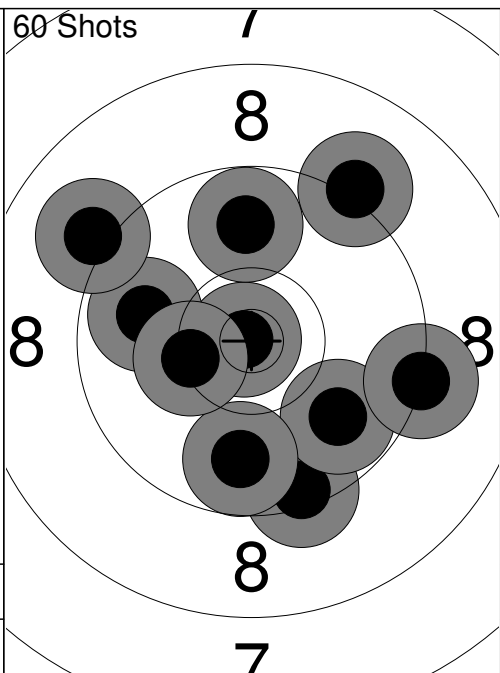

41:	10.9x	↙
42:	9.4	↓
43:	9.8	↘
44:	9.8	↓
45:	9.1	↗
46:	9.2	→
47:	9.9	←
48:	9.1	↖
49:	10.3	←
50:	9.8	↑
Series	92 (1x)	
	475 (10x)	

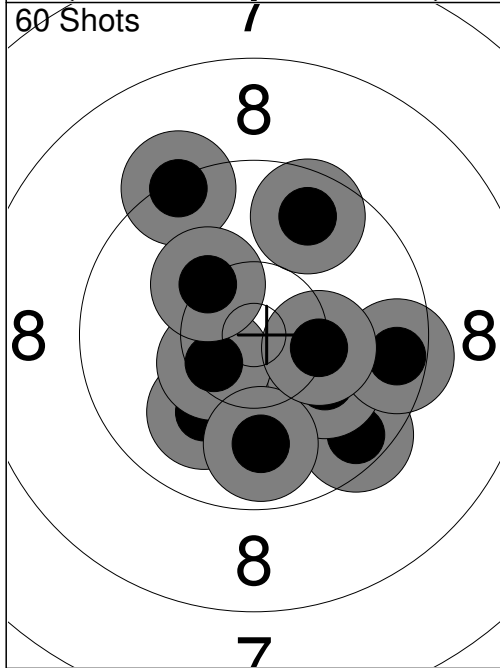

51:	10.0	↙
52:	9.5	↘
53:	9.7	↗
54:	10.1	↘
55:	10.5x	↙
56:	9.3	↗
57:	9.9	↓
58:	9.5	→
59:	10.3	→
60:	10.3	↖
Series	95 (1x)	
	570 (11x)	

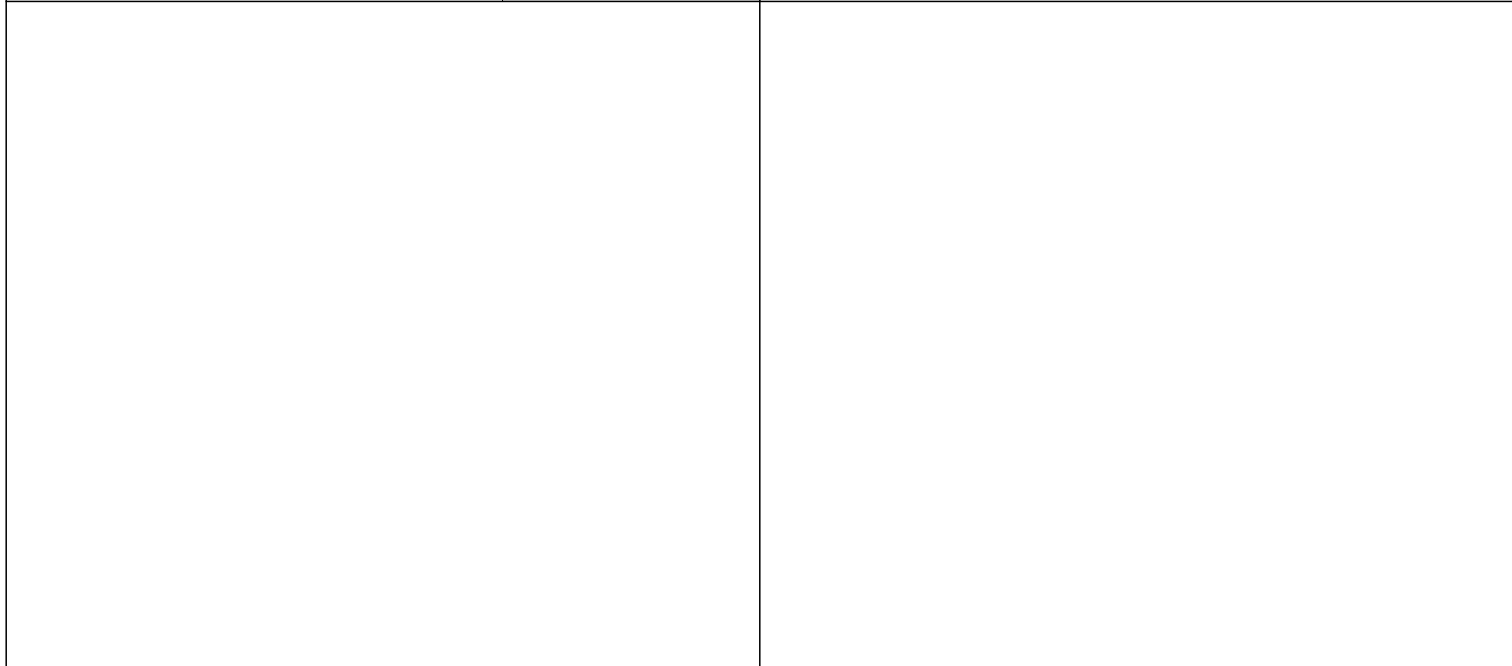

Relay 1	Lane 22	KOZIC Igor
-------------------	-------------------	-------------------

2023 SFC Pistol Nationals	ON	MA	MP
---------------------------	----	----	----

15.07.2023	PN23AP-Q-1	Alberta Handgun Association
------------	------------	-----------------------------

Comment	Signature
---------	-----------

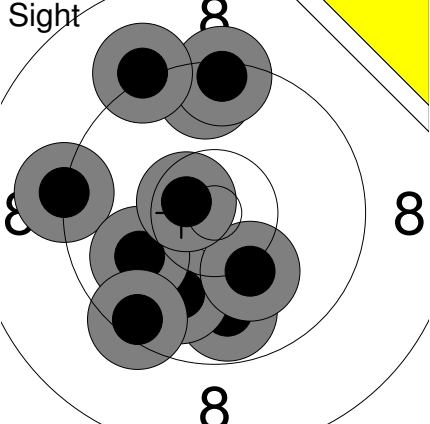
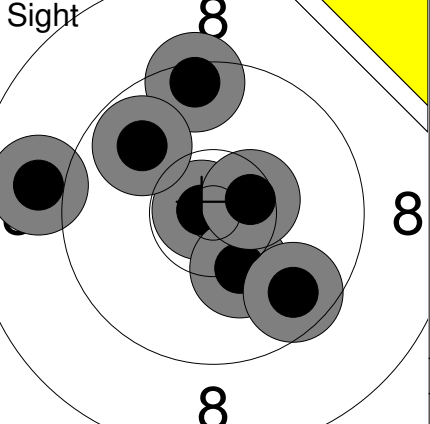
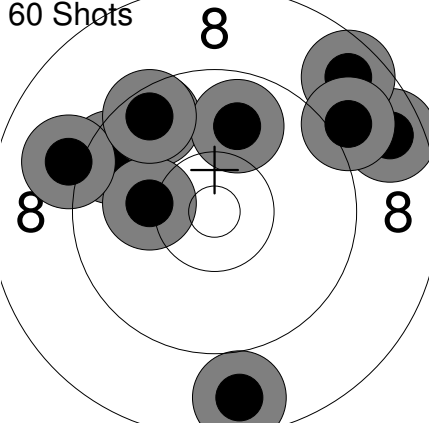
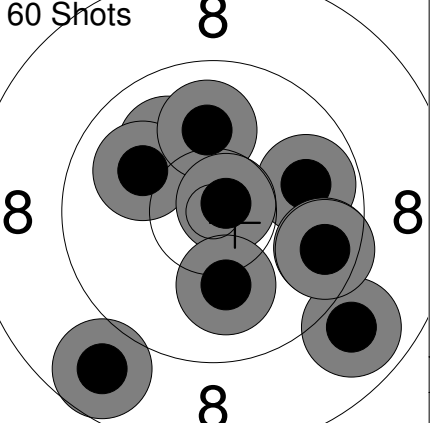
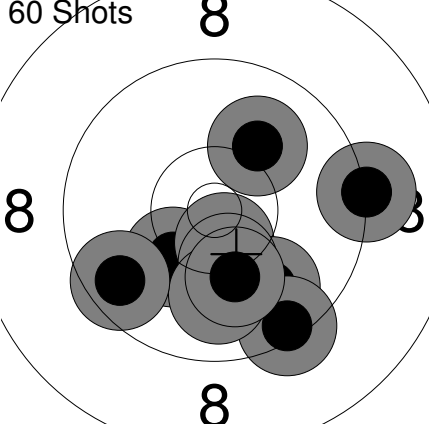
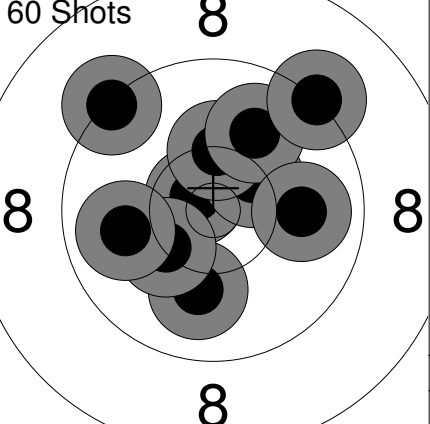
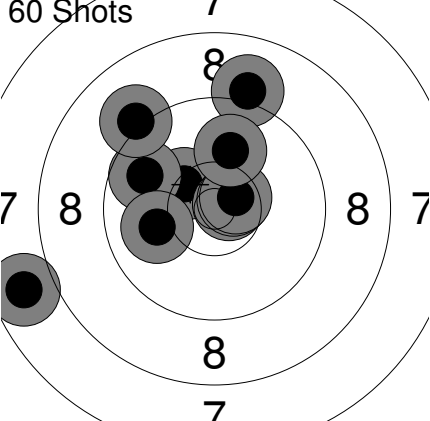
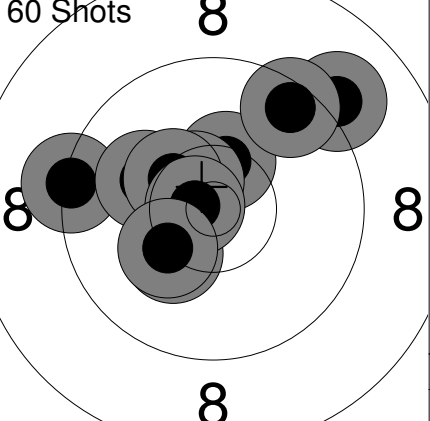
Sight 	<table border="1" style="width:100%; border-collapse: collapse;"> <tr><td>1:</td><td>9.8</td><td>↓</td></tr> <tr><td>2:</td><td>10.0</td><td>↓</td></tr> <tr><td>3:</td><td>9.2</td><td>←</td></tr> <tr><td>4:</td><td>9.5</td><td>↑</td></tr> <tr><td>5:</td><td>10.0</td><td>←</td></tr> <tr><td>6:</td><td>9.4</td><td>↑</td></tr> <tr><td>7:</td><td>9.2</td><td>↗</td></tr> <tr><td>8:</td><td>10.2</td><td>↓</td></tr> <tr><td>9:</td><td>10.6x</td><td>↗</td></tr> <tr><td>10:</td><td>9.5</td><td>↓</td></tr> <tr><td colspan="2">Series</td><td>94 (1x)</td></tr> <tr><td colspan="2"></td><td>0 (0x)</td></tr> </table>	1:	9.8	↓	2:	10.0	↓	3:	9.2	←	4:	9.5	↑	5:	10.0	←	6:	9.4	↑	7:	9.2	↗	8:	10.2	↓	9:	10.6x	↗	10:	9.5	↓	Series		94 (1x)			0 (0x)	Sight 	<table border="1" style="width:100%; border-collapse: collapse;"> <tr><td>11:</td><td>10.8x</td><td>←</td></tr> <tr><td>12:</td><td>8.9</td><td>←</td></tr> <tr><td>13:</td><td>9.4</td><td>↑</td></tr> <tr><td>14:</td><td>10.3</td><td>↓</td></tr> <tr><td>15:</td><td>9.8</td><td>↗</td></tr> <tr><td>16:</td><td>9.7</td><td>↓</td></tr> <tr><td>17:</td><td>10.5x</td><td>→</td></tr> <tr><td colspan="2">Series</td><td>65 (2x)</td></tr> <tr><td colspan="2"></td><td>0 (0x)</td></tr> </table>	11:	10.8x	←	12:	8.9	←	13:	9.4	↑	14:	10.3	↓	15:	9.8	↗	16:	9.7	↓	17:	10.5x	→	Series		65 (2x)			0 (0x)									
1:	9.8	↓																																																																									
2:	10.0	↓																																																																									
3:	9.2	←																																																																									
4:	9.5	↑																																																																									
5:	10.0	←																																																																									
6:	9.4	↑																																																																									
7:	9.2	↗																																																																									
8:	10.2	↓																																																																									
9:	10.6x	↗																																																																									
10:	9.5	↓																																																																									
Series		94 (1x)																																																																									
		0 (0x)																																																																									
11:	10.8x	←																																																																									
12:	8.9	←																																																																									
13:	9.4	↑																																																																									
14:	10.3	↓																																																																									
15:	9.8	↗																																																																									
16:	9.7	↓																																																																									
17:	10.5x	→																																																																									
Series		65 (2x)																																																																									
		0 (0x)																																																																									
60 Shots 	<table border="1" style="width:100%; border-collapse: collapse;"> <tr><td>1:</td><td>9.6</td><td>←</td></tr> <tr><td>2:</td><td>9.6</td><td>↗</td></tr> <tr><td>3:</td><td>10.2</td><td>←</td></tr> <tr><td>4:</td><td>9.9</td><td>↑</td></tr> <tr><td>5:</td><td>9.1</td><td>←</td></tr> <tr><td>6:</td><td>8.7</td><td>↓</td></tr> <tr><td>7:</td><td>9.6</td><td>↗</td></tr> <tr><td>8:</td><td>8.6</td><td>→</td></tr> <tr><td>9:</td><td>8.7</td><td>↗</td></tr> <tr><td>10:</td><td>9.0</td><td>↗</td></tr> <tr><td colspan="2">Series</td><td>88 (0x)</td></tr> <tr><td colspan="2"></td><td>88 (0x)</td></tr> </table>	1:	9.6	←	2:	9.6	↗	3:	10.2	←	4:	9.9	↑	5:	9.1	←	6:	8.7	↓	7:	9.6	↗	8:	8.6	→	9:	8.7	↗	10:	9.0	↗	Series		88 (0x)			88 (0x)	60 Shots 	<table border="1" style="width:100%; border-collapse: collapse;"> <tr><td>11:</td><td>9.9</td><td>→</td></tr> <tr><td>12:</td><td>10.0</td><td>↗</td></tr> <tr><td>13:</td><td>10.0</td><td>↗</td></tr> <tr><td>14:</td><td>10.0</td><td>↑</td></tr> <tr><td>15:</td><td>10.8x</td><td>↗</td></tr> <tr><td>16:</td><td>8.9</td><td>↓</td></tr> <tr><td>17:</td><td>9.6</td><td>→</td></tr> <tr><td>18:</td><td>10.1</td><td>↓</td></tr> <tr><td>19:</td><td>8.8</td><td>↓</td></tr> <tr><td>20:</td><td>9.6</td><td>→</td></tr> <tr><td colspan="2">Series</td><td>93 (1x)</td></tr> <tr><td colspan="2"></td><td>181 (1x)</td></tr> </table>	11:	9.9	→	12:	10.0	↗	13:	10.0	↗	14:	10.0	↑	15:	10.8x	↗	16:	8.9	↓	17:	9.6	→	18:	10.1	↓	19:	8.8	↓	20:	9.6	→	Series		93 (1x)			181 (1x)
1:	9.6	←																																																																									
2:	9.6	↗																																																																									
3:	10.2	←																																																																									
4:	9.9	↑																																																																									
5:	9.1	←																																																																									
6:	8.7	↓																																																																									
7:	9.6	↗																																																																									
8:	8.6	→																																																																									
9:	8.7	↗																																																																									
10:	9.0	↗																																																																									
Series		88 (0x)																																																																									
		88 (0x)																																																																									
11:	9.9	→																																																																									
12:	10.0	↗																																																																									
13:	10.0	↗																																																																									
14:	10.0	↑																																																																									
15:	10.8x	↗																																																																									
16:	8.9	↓																																																																									
17:	9.6	→																																																																									
18:	10.1	↓																																																																									
19:	8.8	↓																																																																									
20:	9.6	→																																																																									
Series		93 (1x)																																																																									
		181 (1x)																																																																									
60 Shots 	<table border="1" style="width:100%; border-collapse: collapse;"> <tr><td>21:</td><td>10.2</td><td>↓</td></tr> <tr><td>22:</td><td>9.2</td><td>→</td></tr> <tr><td>23:</td><td>10.6x</td><td>↓</td></tr> <tr><td>24:</td><td>9.9</td><td>↓</td></tr> <tr><td>25:</td><td>9.4</td><td>↓</td></tr> <tr><td>26:</td><td>10.3</td><td>↓</td></tr> <tr><td>27:</td><td>10.0</td><td>↓</td></tr> <tr><td>28:</td><td>10.2</td><td>↓</td></tr> <tr><td>29:</td><td>10.1</td><td>↗</td></tr> <tr><td>30:</td><td>9.6</td><td>←</td></tr> <tr><td colspan="2">Series</td><td>96 (1x)</td></tr> <tr><td colspan="2"></td><td>277 (2x)</td></tr> </table>	21:	10.2	↓	22:	9.2	→	23:	10.6x	↓	24:	9.9	↓	25:	9.4	↓	26:	10.3	↓	27:	10.0	↓	28:	10.2	↓	29:	10.1	↗	30:	9.6	←	Series		96 (1x)			277 (2x)	60 Shots 	<table border="1" style="width:100%; border-collapse: collapse;"> <tr><td>31:</td><td>10.7x</td><td>↖</td></tr> <tr><td>32:</td><td>10.4x</td><td>↗</td></tr> <tr><td>33:</td><td>10.3</td><td>↑</td></tr> <tr><td>34:</td><td>10.0</td><td>↑</td></tr> <tr><td>35:</td><td>9.2</td><td>↗</td></tr> <tr><td>36:</td><td>9.3</td><td>↖</td></tr> <tr><td>37:</td><td>10.0</td><td>↓</td></tr> <tr><td>38:</td><td>10.3</td><td>←</td></tr> <tr><td>39:</td><td>9.9</td><td>→</td></tr> <tr><td>40:</td><td>9.9</td><td>←</td></tr> <tr><td colspan="2">Series</td><td>96 (2x)</td></tr> <tr><td colspan="2"></td><td>373 (4x)</td></tr> </table>	31:	10.7x	↖	32:	10.4x	↗	33:	10.3	↑	34:	10.0	↑	35:	9.2	↗	36:	9.3	↖	37:	10.0	↓	38:	10.3	←	39:	9.9	→	40:	9.9	←	Series		96 (2x)			373 (4x)
21:	10.2	↓																																																																									
22:	9.2	→																																																																									
23:	10.6x	↓																																																																									
24:	9.9	↓																																																																									
25:	9.4	↓																																																																									
26:	10.3	↓																																																																									
27:	10.0	↓																																																																									
28:	10.2	↓																																																																									
29:	10.1	↗																																																																									
30:	9.6	←																																																																									
Series		96 (1x)																																																																									
		277 (2x)																																																																									
31:	10.7x	↖																																																																									
32:	10.4x	↗																																																																									
33:	10.3	↑																																																																									
34:	10.0	↑																																																																									
35:	9.2	↗																																																																									
36:	9.3	↖																																																																									
37:	10.0	↓																																																																									
38:	10.3	←																																																																									
39:	9.9	→																																																																									
40:	9.9	←																																																																									
Series		96 (2x)																																																																									
		373 (4x)																																																																									
60 Shots 	<table border="1" style="width:100%; border-collapse: collapse;"> <tr><td>41:</td><td>9.1</td><td>↑</td></tr> <tr><td>42:</td><td>10.3</td><td>↗</td></tr> <tr><td>43:</td><td>7.7</td><td>←</td></tr> <tr><td>44:</td><td>9.8</td><td>↖</td></tr> <tr><td>45:</td><td>10.7x</td><td>→</td></tr> <tr><td>46:</td><td>9.1</td><td>↗</td></tr> <tr><td>47:</td><td>10.6x</td><td>→</td></tr> <tr><td>48:</td><td>10.6x</td><td>→</td></tr> <tr><td>49:</td><td>10.0</td><td>↑</td></tr> <tr><td>50:</td><td>10.0</td><td>←</td></tr> <tr><td colspan="2">Series</td><td>94 (3x)</td></tr> <tr><td colspan="2"></td><td>467 (7x)</td></tr> </table>	41:	9.1	↑	42:	10.3	↗	43:	7.7	←	44:	9.8	↖	45:	10.7x	→	46:	9.1	↗	47:	10.6x	→	48:	10.6x	→	49:	10.0	↑	50:	10.0	←	Series		94 (3x)			467 (7x)	60 Shots 	<table border="1" style="width:100%; border-collapse: collapse;"> <tr><td>51:</td><td>10.3</td><td>↘</td></tr> <tr><td>52:</td><td>9.3</td><td>←</td></tr> <tr><td>53:</td><td>10.4x</td><td>↑</td></tr> <tr><td>54:</td><td>10.1</td><td>↖</td></tr> <tr><td>55:</td><td>10.6x</td><td>↗</td></tr> <tr><td>56:</td><td>10.4x</td><td>↖</td></tr> <tr><td>57:</td><td>9.1</td><td>↗</td></tr> <tr><td>58:</td><td>9.5</td><td>↗</td></tr> <tr><td>59:</td><td>10.7x</td><td>←</td></tr> <tr><td>60:</td><td>10.3</td><td>↘</td></tr> <tr><td colspan="2">Series</td><td>97 (4x)</td></tr> <tr><td colspan="2"></td><td>564 (11x)</td></tr> </table>	51:	10.3	↘	52:	9.3	←	53:	10.4x	↑	54:	10.1	↖	55:	10.6x	↗	56:	10.4x	↖	57:	9.1	↗	58:	9.5	↗	59:	10.7x	←	60:	10.3	↘	Series		97 (4x)			564 (11x)
41:	9.1	↑																																																																									
42:	10.3	↗																																																																									
43:	7.7	←																																																																									
44:	9.8	↖																																																																									
45:	10.7x	→																																																																									
46:	9.1	↗																																																																									
47:	10.6x	→																																																																									
48:	10.6x	→																																																																									
49:	10.0	↑																																																																									
50:	10.0	←																																																																									
Series		94 (3x)																																																																									
		467 (7x)																																																																									
51:	10.3	↘																																																																									
52:	9.3	←																																																																									
53:	10.4x	↑																																																																									
54:	10.1	↖																																																																									
55:	10.6x	↗																																																																									
56:	10.4x	↖																																																																									
57:	9.1	↗																																																																									
58:	9.5	↗																																																																									
59:	10.7x	←																																																																									
60:	10.3	↘																																																																									
Series		97 (4x)																																																																									
		564 (11x)																																																																									

Relay 1	Lane 23	HYNES Mark			
-------------------	-------------------	-------------------	--	--	--

2023 SFC Pistol Nationals	ON	MA	MP
---------------------------	----	----	----

15.07.2023	PN23AP-Q-1	Alberta Handgun Association
------------	------------	-----------------------------

Comment	Signature
---------	-----------

Sight 	1: 10.0 ↓	Sight 	11: 9.9 ↗
	2: 9.0 →		12: 9.1 ←
	3: 10.4x ←		13: 9.8 ←
	4: 9.8 →		14: 9.2 ↙
	5: 10.1 ↗		15: 9.8 ↘
	6: 10.3 ↓		
	7: 9.5 ←		
	8: 10.1 ↑		
	9: 10.1 ↓		
	10: 9.9 ←		
	Series 96 (1x)		Series 45 (0x)
	0 (0x)		0 (0x)
60 Shots 	1: 8.7 ↙	60 Shots 	11: 10.9x ↑
	2: 10.9x →		12: 9.7 ↘
	3: 9.7 ↗		13: 8.4 ↓
	4: 9.6 ↗		14: 9.7 ←
	5: 10.3 ↓		15: 10.0 ↓
	6: 10.6x ↓		16: 9.1 →
	7: 10.9x ↗		17: 10.1 ←
	8: 10.2 ↓		18: 10.2 ←
	9: 10.8x ←		19: 10.5x ↓
	10: 9.3 ↙		20: 10.2 ↙
	Series 95 (4x)		Series 95 (2x)
	95 (4x)		190 (6x)
60 Shots 	21: 8.9 ↓	60 Shots 	31: 10.6x ↓
	22: 10.1 ↓		32: 9.1 ↙
	23: 9.3 ←		33: 9.4 →
	24: 10.5x ←		34: 10.1 ↘
	25: 10.4x ↘		35: 10.0 ↓
	26: 10.2 ↓		36: 10.7x ↓
	27: 8.8 ↙		37: 9.8 ↙
	28: 9.6 ←		38: 8.2 ←
	29: 10.6x ↖		39: 9.8 →
	30: 9.4 ←		40: 10.6x ↑
	Series 93 (3x)		Series 94 (3x)
	283 (9x)		377 (12x)
60 Shots 	41: 9.8 ←	60 Shots 	51: 9.8 ↓
	42: 9.6 ←		52: 10.6x ←
	43: 10.2 →		53: 10.0 ↗
	44: 9.5 ↓		54: 10.7x ↓
	45: 10.0 ↗		55: 9.6 ←
	46: 9.9 ↗		56: 10.6x ↑
	47: 9.2 →		57: 9.7 ↓
	48: 9.7 ↓		58: 10.4x →
	49: 9.2 ←		59: 9.0 ↓
	50: 9.4 →		60: 10.6x ↗
	Series 92 (0x)		Series 96 (5x)
	469 (12x)		565 (17x)

Relay **1** Lane **24** **SHAWN Richard**

2023 SFC Pistol Nationals BC MA MP

15.07.2023 PN23AP-Q-1 Alberta Handgun Association

Comment Signature

	1: 7.9 ↗		1: 5.2 ↘
	2: 6.3 ←		2: 9.3 ↘
	3: 7.8 ←		3: 10.5x ↗
	4: 9.6 ↗		4: 9.2 ←
	5: 2.7 ←		5: 0.0 ↘
	6: 6.1 ↗		6: 10.4x ←
	7: 8.9 ↘		7: 7.0 ←
	8: 10.2 ↘		8: 7.9 ↘
	9: 6.6 ←		9: 10.3 →
	Series 61 (0x)		Series 71 (2x)
	0 (0x)		71 (2x)

	11: 8.3 ↘		21: 8.9 ↘
	12: 4.8 ←		22: 8.8 ↗
	13: 8.6 ←		23: 10.4x ←
	14: 8.1 →		24: 8.2 ↘
	15: 6.4 ↘		25: 10.2 ↗
	16: 8.8 ↘		26: 8.3 →
	17: 8.2 ↘		27: 5.5 ←
	18: 8.0 →		28: 8.4 ←
	19: 7.8 ↘		29: 8.4 ↗
	20: 6.7 ↘		30: 6.1 ↘
	Series 71 (0x)		Series 79 (1x)
	142 (2x)		221 (3x)

	31: 0.0 ←		41: 8.4 ←
	32: 6.1 →		42: 9.2 ←
	33: 7.8 ↘		43: 9.6 ↗
	34: 10.7x ↗		44: 8.7 ←
	35: 9.7 →		45: 8.0 ↗
	36: 5.1 ←		46: 4.8 ↘
	37: 10.4x ↘		47: 9.2 ↘
	38: 9.7 →		48: 6.1 ↘
	39: 9.2 ↗		49: 7.7 ↘
	40: 8.4 ←		50: 8.9 ←
	Series 73 (2x)		Series 76 (0x)
	294 (5x)		370 (5x)

	51: 7.2 →		
	52: 8.8 ←		
	53: 6.4 →		
	54: 10.0 ↘		
	55: 6.6 ←		
	56: 7.7 ↘		
	57: 9.0 ↘		
	58: 8.8 ←		
	59: 8.5 →		
	60: 9.6 ←		
	Series 78 (0x)		
	448 (5x)		

Relay **1** Lane **26** **WICK Werner**

2023 SFC Pistol Nationals AB MA MP

15.07.2023 PN23AP-Q-1 Alberta Handgun Association

Comment Signature

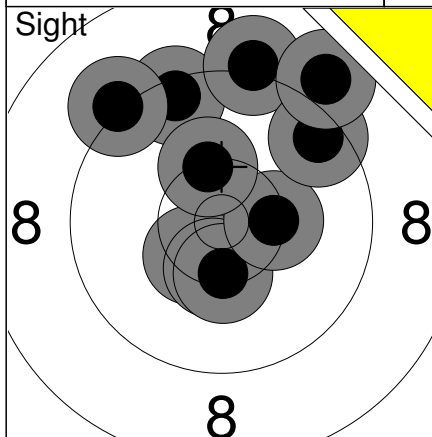

1:	9.4	↑
2:	10.5x	↙
3:	9.1	↑
4:	10.4x	↓
5:	10.4x	↓
6:	10.4x	→
7:	9.5	↗
8:	8.9	↗
9:	10.3	↑
10:	9.2	↖
Series	94 (4x)	
	0 (0x)	

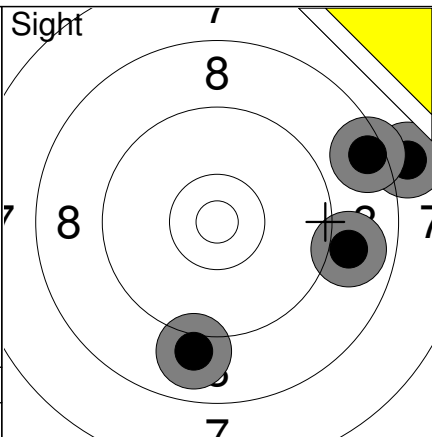

11:	9.0	↓
12:	7.9	→
13:	8.9	→
14:	8.5	→
Series	32 (0x)	
	0 (0x)	

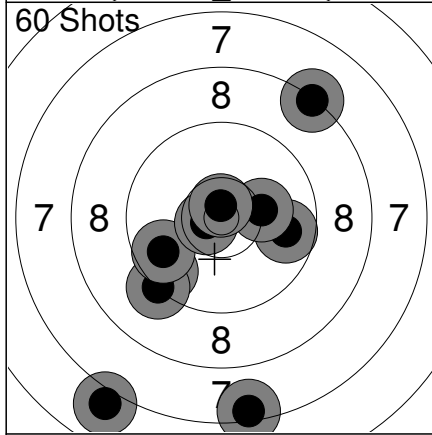

1:	9.6	↙
2:	9.8	→
3:	10.2	→
4:	7.4	↓
5:	9.2	↙
6:	8.3	↗
7:	9.7	↙
8:	7.0	↓
9:	10.7x	←
10:	10.7x	↑
Series	88 (2x)	
	88 (2x)	

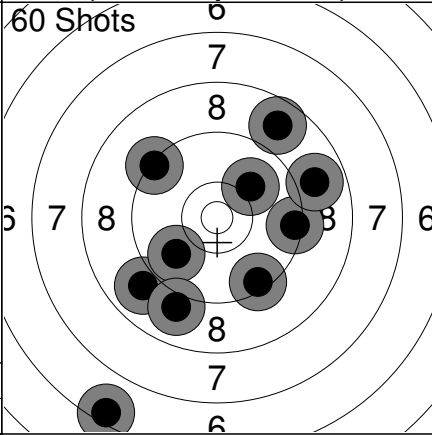

11:	9.4	↓
12:	6.4	↙
13:	9.4	→
14:	9.3	↗
15:	8.9	↙
16:	10.0	↗
17:	8.7	↗
18:	9.9	↙
19:	9.0	↓
20:	8.9	→
Series	85 (0x)	
	173 (2x)	

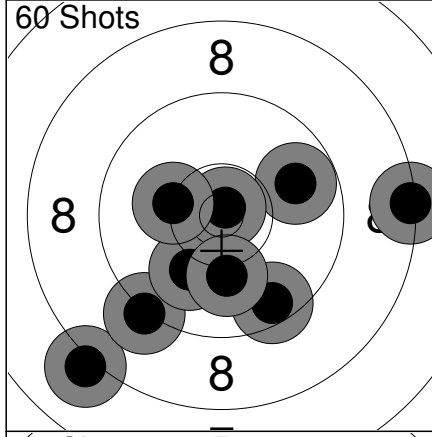

21:	8.1	↙
22:	9.8	→
23:	9.2	↙
24:	10.9x	↗
25:	9.5	↓
26:	10.1	↙
27:	10.8x	↗
28:	10.2	←
29:	10.1	↓
30:	8.3	→
Series	93 (2x)	
	266 (4x)	

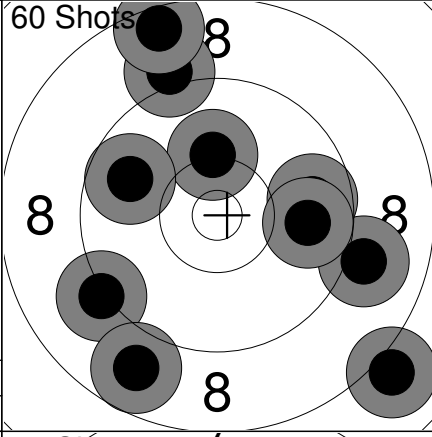

31:	9.0	→
32:	10.2	↑
33:	9.8	↖
34:	9.2	↙
35:	9.1	↑
36:	8.5	↑
37:	9.7	→
38:	8.0	↘
39:	8.8	↓
40:	9.8	→
Series	88 (0x)	
	354 (4x)	

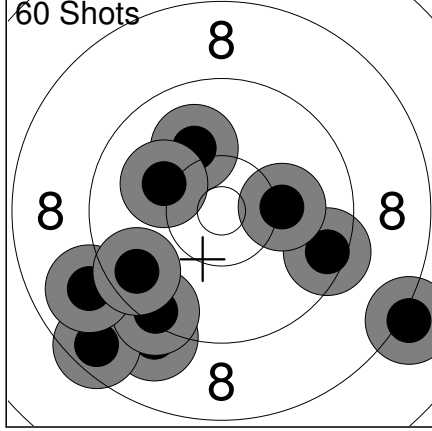

41:	9.1	↓
42:	8.6	↙
43:	9.5	→
44:	9.4	↙
45:	10.1	↗
46:	8.1	↓
47:	10.2	→
48:	10.1	↖
49:	9.0	↙
50:	9.6	↙
Series	91 (0x)	
	445 (4x)	

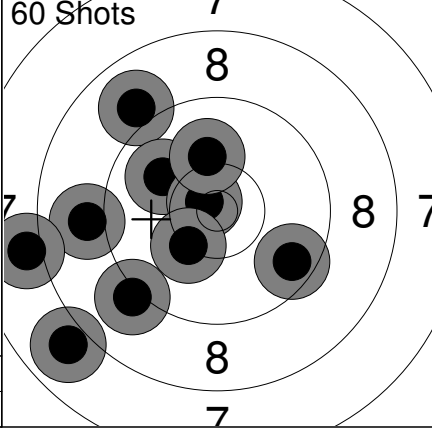

51:	9.6	↘
52:	9.0	↗
53:	10.0	↗
54:	9.0	←
55:	10.7x	↖
56:	7.9	↙
57:	9.1	↙
58:	10.3	↙
59:	10.1	↑
60:	8.0	←
Series	91 (1x)	
	536 (5x)	

Relay 1	Lane 27	GUIMONT Alain
-------------------	-------------------	----------------------

2023 SFC Pistol Nationals	QC	MA	MP
---------------------------	----	----	----

15.07.2023	PN23AP-Q-1	Alberta Handgun Association
------------	------------	-----------------------------

Comment	Signature
---------	-----------

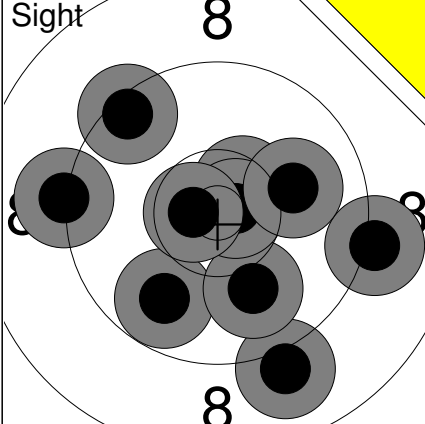
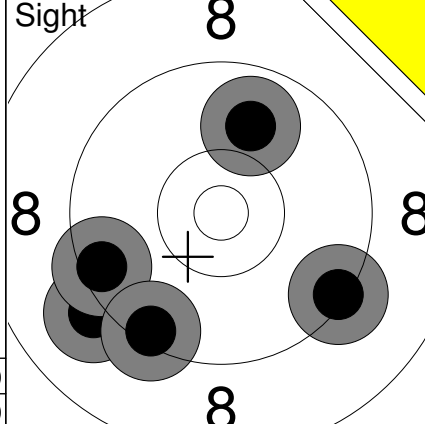
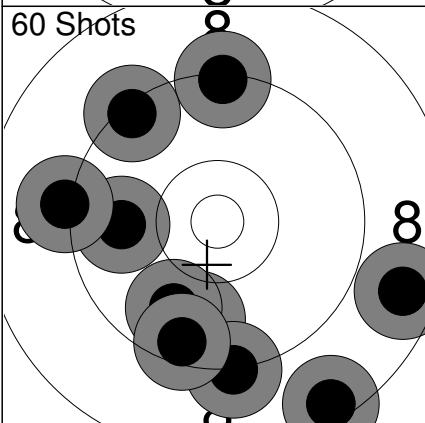
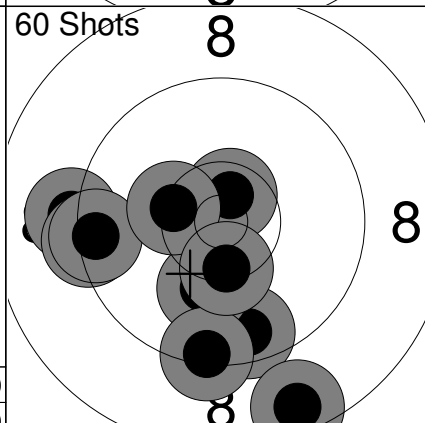
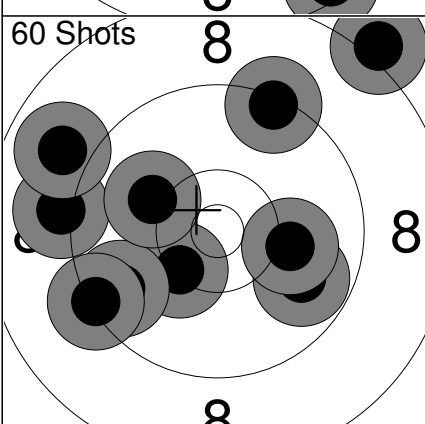
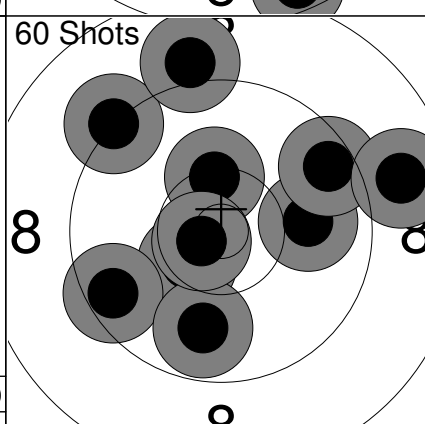
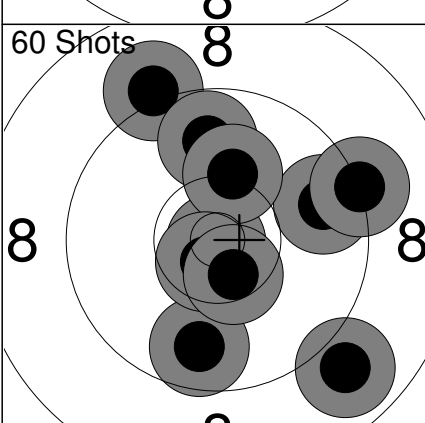
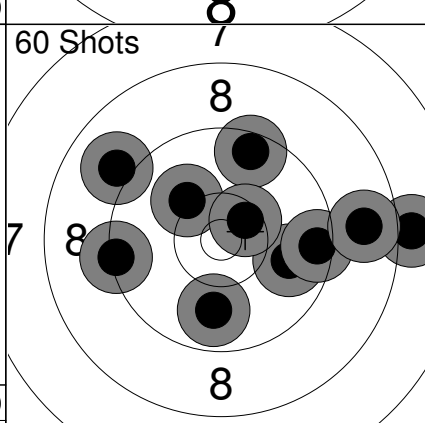
<p>Sight</p> 	<p>1: 9.1 → 2: 9.0 ↓ 3: 10.5x → 4: 9.8 ← 5: 9.2 ← 6: 10.0 ↓ 7: 10.7x → 8: 9.4 ↗ 9: 10.7x ← 10: 10.0 →</p> <p>Series 95 (3x) 0 (0x)</p>	<p>Sight</p> 	<p>11: 9.1 ↙ 12: 9.9 ↑ 13: 9.5 ← 14: 9.3 → 15: 9.4 ↘</p> <p>Series 45 (0x) 0 (0x)</p>
<p>60 Shots</p> 	<p>1: 9.8 ← 2: 9.3 ↑ 3: 9.8 ↓ 4: 9.8 ↓ 5: 9.2 ↓ 6: 9.3 ↗ 7: 8.4 ↓ 8: 8.6 → 9: 9.5 ↓ 10: 9.2 ←</p> <p>Series 88 (0x) 88 (0x)</p>	<p>60 Shots</p> 	<p>11: 10.6x ↑ 12: 9.2 ← 13: 9.6 ↓ 14: 8.5 ↓ 15: 10.1 ↓ 16: 9.3 ← 17: 9.4 ← 18: 9.4 ↓ 19: 10.4 ← 20: 10.4x ↓</p> <p>Series 93 (2x) 181 (2x)</p>
<p>60 Shots</p> 	<p>21: 10.3 ↙ 22: 9.8 ↓ 23: 9.1 ← 24: 8.9 ↗ 25: 10.1 → 26: 9.6 ← 27: 10.1 ↗ 28: 9.3 ↑ 29: 9.3 ← 30: 8.1 ↗</p> <p>Series 91 (0x) 272 (2x)</p>	<p>60 Shots</p> 	<p>31: 10.0 → 32: 10.4x ↙ 33: 10.3 ↑ 34: 9.5 ↗ 35: 9.2 ↗ 36: 9.0 ↑ 37: 9.5 ← 38: 9.8 ↓ 39: 8.8 → 40: 10.7x ↙</p> <p>Series 93 (2x) 365 (4x)</p>
<p>60 Shots</p> 	<p>41: 9.7 ↓ 42: 9.1 ↑ 43: 9.8 ↑ 44: 8.9 ↓ 45: 10.9x ↓ 46: 9.7 → 47: 9.2 → 48: 10.2 ↑ 49: 10.7x ↓ 50: 10.5x ↓</p> <p>Series 93 (3x) 458 (7x)</p>	<p>60 Shots</p> 	<p>51: 10.1 ↖ 52: 9.3 ← 53: 9.5 ↑ 54: 9.0 ↖ 55: 9.9 → 56: 8.0 → 57: 9.5 → 58: 10.5x ↗ 59: 9.9 ↓ 60: 8.8 →</p> <p>Series 90 (1x) 548 (8x)</p>

Relay **1** Lane **28** **AASA Toomas**

2023 SFC Pistol Nationals ON MA MP

15.07.2023 PN23AP-Q-1 Alberta Handgun Association

Comment Signature

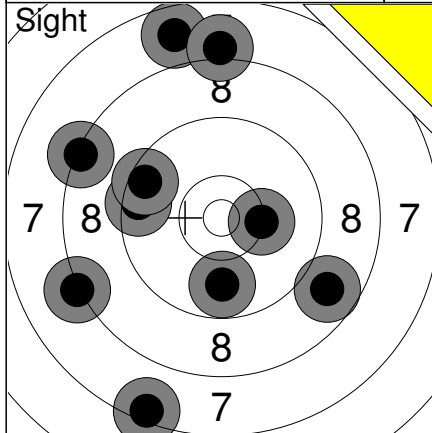

1:	10.3	→
2:	8.8	↘
3:	7.7	↗
4:	9.8	↘
5:	9.5	←
6:	8.2	↙
7:	7.4	↘
8:	8.0	↑
9:	8.3	↗
10:	9.5	↖
Series	83 (0x)	
	0 (0x)	

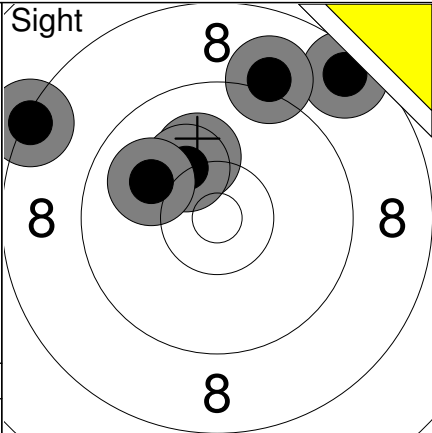

11:	8.3	↖
12:	10.1	↑
13:	8.5	↗
14:	10.2	↗
15:	9.1	↑
16:	10.0	↖
Series	55 (0x)	
	0 (0x)	

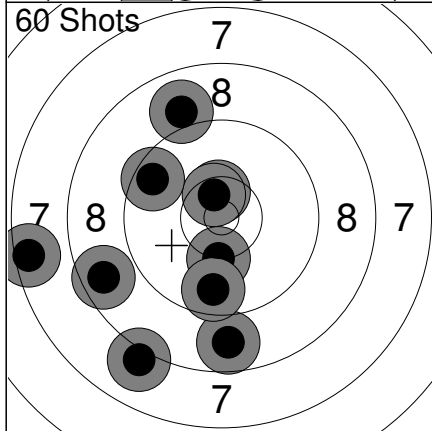

1:	10.5x	↑
2:	7.5	←
3:	10.5x	↗
4:	9.6	↖
5:	10.2	↘
6:	8.9	↗
7:	8.7	↘
8:	8.6	←
9:	9.7	↘
10:	8.1	↘
Series	87 (2x)	
	87 (2x)	

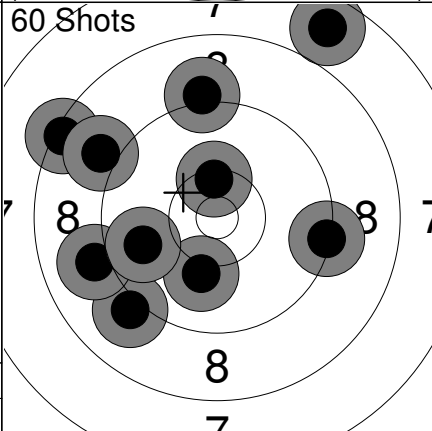

11:	8.4	↖
12:	9.1	↙
13:	9.0	↖
14:	10.1	↘
15:	9.3	→
16:	9.0	←
17:	9.8	←
18:	7.7	↗
19:	10.4x	↑
20:	9.1	↑
Series	89 (1x)	
	176 (3x)	

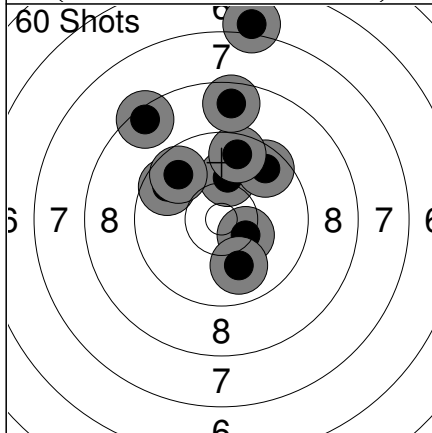

21:	10.1	↑
22:	9.7	↖
23:	7.0	↑
24:	9.7	↗
25:	9.6	↗
26:	8.5	↗
27:	10.4x	↘
28:	9.6	↑
29:	8.6	↑
30:	10.0	↘
Series	89 (1x)	
	265 (4x)	

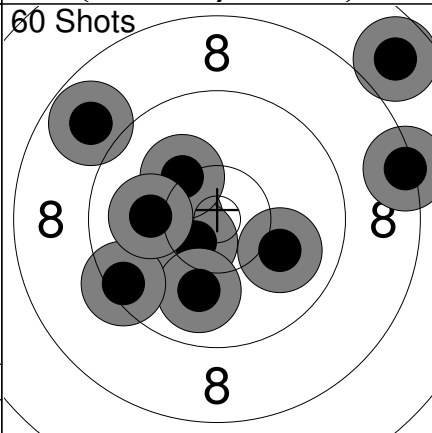

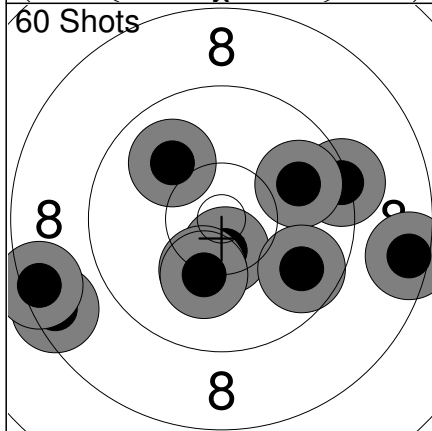

31:	7.7	↗
32:	10.5x	←
33:	10.0	→
34:	10.5x	↙
35:	10.2	↗
36:	10.0	↘
37:	8.8	↗
38:	8.3	→
39:	9.4	↙
40:	10.1	←
Series	92 (2x)	
	357 (6x)	

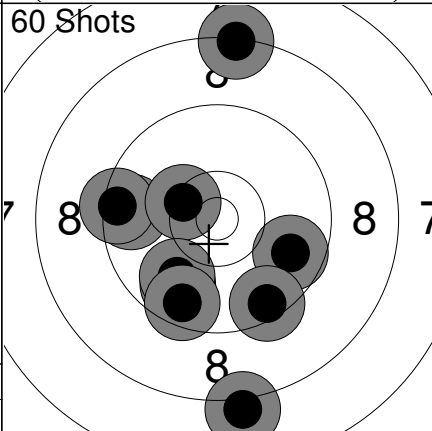

41:	10.5x	↘
42:	10.3	↘
43:	9.3	→
44:	10.2	↘
45:	9.9	→
46:	8.5	↙
47:	8.5	↙
48:	10.0	↗
49:	8.5	→
50:	9.7	↘
Series	91 (1x)	
	448 (7x)	

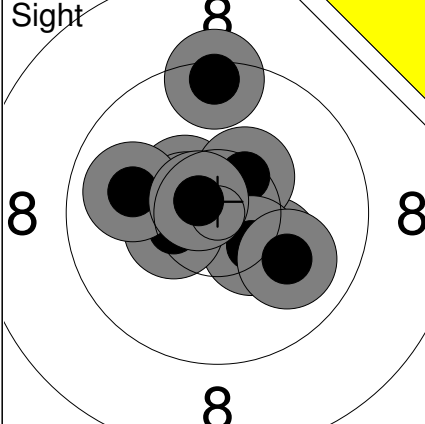
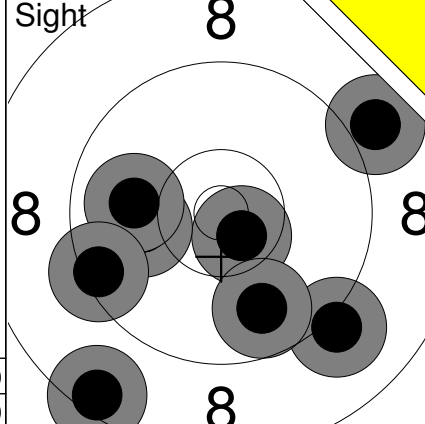
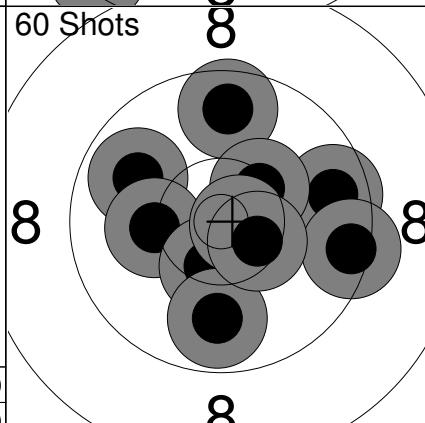
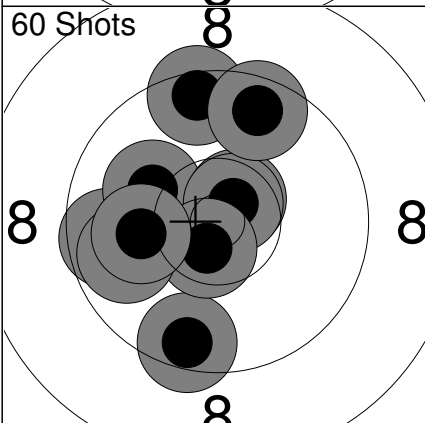
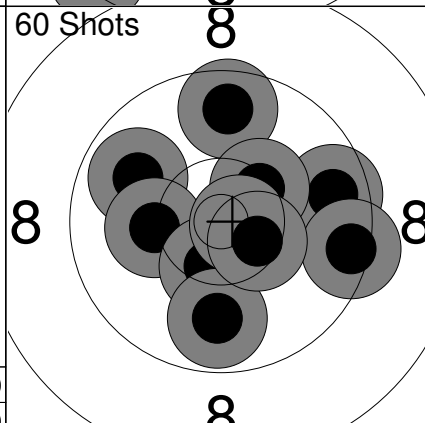
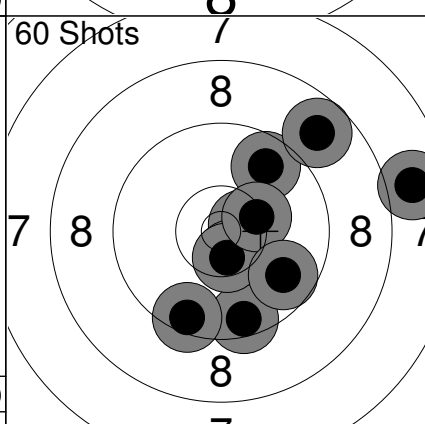
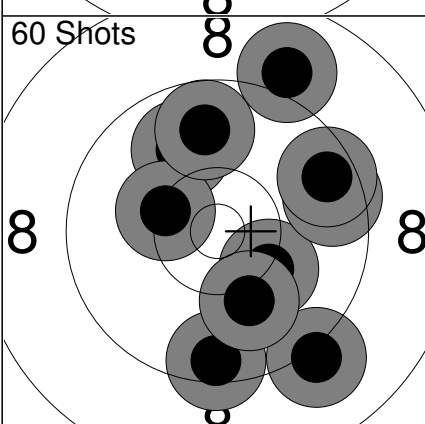
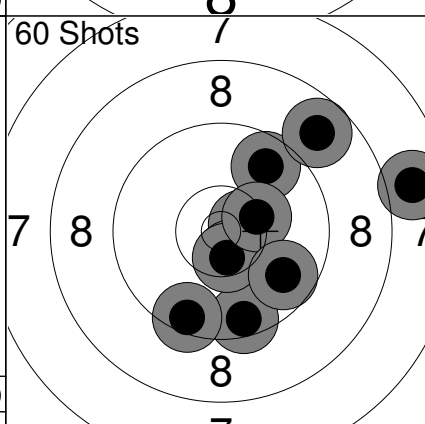
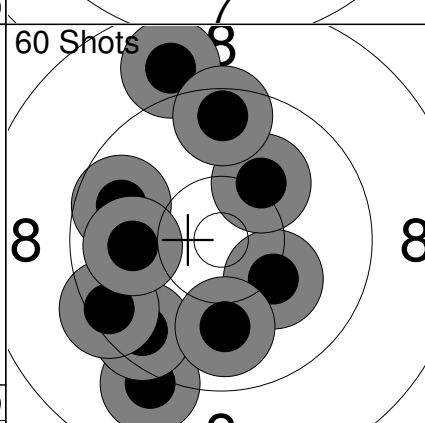
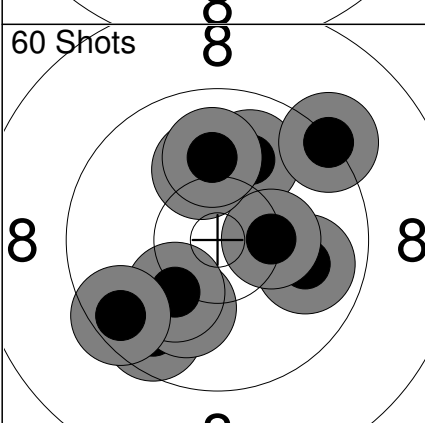
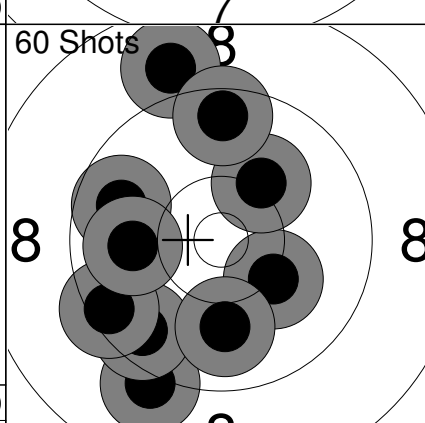

51:	9.7	←
52:	9.4	←
53:	8.1	↘
54:	10.4x	↖
55:	9.8	↘
56:	9.7	→
57:	9.9	↙
58:	9.5	↘
59:	9.6	↘
60:	8.3	↑
Series	89 (1x)	
	537 (8x)	

Sight																																																																										
	<table border="1" style="width:100%; border-collapse: collapse;"> <tr><td>1:</td><td>9.4</td><td>↑</td></tr> <tr><td>2:</td><td>10.2</td><td>↘</td></tr> <tr><td>3:</td><td>10.5x</td><td>↗</td></tr> <tr><td>4:</td><td>10.6x</td><td>↖</td></tr> <tr><td>5:</td><td>10.4x</td><td>↗</td></tr> <tr><td>6:</td><td>10.4x</td><td>↘</td></tr> <tr><td>7:</td><td>10.4x</td><td>↖</td></tr> <tr><td>8:</td><td>10.0</td><td>↖</td></tr> <tr><td>9:</td><td>10.0</td><td>↘</td></tr> <tr><td>10:</td><td>10.7x</td><td>↗</td></tr> <tr><td>Series</td><td>99 (6x)</td><td></td></tr> <tr><td></td><td>0 (0x)</td><td></td></tr> </table>	1:	9.4	↑	2:	10.2	↘	3:	10.5x	↗	4:	10.6x	↖	5:	10.4x	↗	6:	10.4x	↘	7:	10.4x	↖	8:	10.0	↖	9:	10.0	↘	10:	10.7x	↗	Series	99 (6x)			0 (0x)		<table border="1" style="width:100%; border-collapse: collapse;"> <tr><td>11:</td><td>10.6x</td><td>↘</td></tr> <tr><td>12:</td><td>9.1</td><td>↘</td></tr> <tr><td>13:</td><td>10.0</td><td>↖</td></tr> <tr><td>14:</td><td>8.9</td><td>↗</td></tr> <tr><td>15:</td><td>10.0</td><td>↖</td></tr> <tr><td>16:</td><td>9.4</td><td>↖</td></tr> <tr><td>17:</td><td>8.4</td><td>↘</td></tr> <tr><td>18:</td><td>9.8</td><td>↘</td></tr> <tr><td>Series</td><td>73 (1x)</td><td></td></tr> <tr><td></td><td>0 (0x)</td><td></td></tr> </table>	11:	10.6x	↘	12:	9.1	↘	13:	10.0	↖	14:	8.9	↗	15:	10.0	↖	16:	9.4	↖	17:	8.4	↘	18:	9.8	↘	Series	73 (1x)			0 (0x)							
1:	9.4	↑																																																																								
2:	10.2	↘																																																																								
3:	10.5x	↗																																																																								
4:	10.6x	↖																																																																								
5:	10.4x	↗																																																																								
6:	10.4x	↘																																																																								
7:	10.4x	↖																																																																								
8:	10.0	↖																																																																								
9:	10.0	↘																																																																								
10:	10.7x	↗																																																																								
Series	99 (6x)																																																																									
	0 (0x)																																																																									
11:	10.6x	↘																																																																								
12:	9.1	↘																																																																								
13:	10.0	↖																																																																								
14:	8.9	↗																																																																								
15:	10.0	↖																																																																								
16:	9.4	↖																																																																								
17:	8.4	↘																																																																								
18:	9.8	↘																																																																								
Series	73 (1x)																																																																									
	0 (0x)																																																																									
60 Shots																																																																										
	<table border="1" style="width:100%; border-collapse: collapse;"> <tr><td>1:</td><td>9.7</td><td>↖</td></tr> <tr><td>2:</td><td>10.1</td><td>↗</td></tr> <tr><td>3:</td><td>10.6x</td><td>↗</td></tr> <tr><td>4:</td><td>9.5</td><td>↘</td></tr> <tr><td>5:</td><td>9.5</td><td>↑</td></tr> <tr><td>6:</td><td>10.7x</td><td>↗</td></tr> <tr><td>7:</td><td>10.6x</td><td>↘</td></tr> <tr><td>8:</td><td>9.9</td><td>↖</td></tr> <tr><td>9:</td><td>10.1</td><td>↖</td></tr> <tr><td>10:</td><td>9.6</td><td>↑</td></tr> <tr><td>Series</td><td>95 (3x)</td><td></td></tr> <tr><td></td><td>95 (3x)</td><td></td></tr> </table>	1:	9.7	↖	2:	10.1	↗	3:	10.6x	↗	4:	9.5	↘	5:	9.5	↑	6:	10.7x	↗	7:	10.6x	↘	8:	9.9	↖	9:	10.1	↖	10:	9.6	↑	Series	95 (3x)			95 (3x)		<table border="1" style="width:100%; border-collapse: collapse;"> <tr><td>11:</td><td>9.9</td><td>↖</td></tr> <tr><td>12:</td><td>9.6</td><td>↗</td></tr> <tr><td>13:</td><td>10.2</td><td>↖</td></tr> <tr><td>14:</td><td>10.4x</td><td>↘</td></tr> <tr><td>15:</td><td>9.7</td><td>↑</td></tr> <tr><td>16:</td><td>10.4x</td><td>↗</td></tr> <tr><td>17:</td><td>9.4</td><td>↗</td></tr> <tr><td>18:</td><td>10.7x</td><td>↗</td></tr> <tr><td>19:</td><td>9.8</td><td>↘</td></tr> <tr><td>20:</td><td>10.5x</td><td>↘</td></tr> <tr><td>Series</td><td>95 (4x)</td><td></td></tr> <tr><td></td><td>190 (7x)</td><td></td></tr> </table>	11:	9.9	↖	12:	9.6	↗	13:	10.2	↖	14:	10.4x	↘	15:	9.7	↑	16:	10.4x	↗	17:	9.4	↗	18:	10.7x	↗	19:	9.8	↘	20:	10.5x	↘	Series	95 (4x)			190 (7x)	
1:	9.7	↖																																																																								
2:	10.1	↗																																																																								
3:	10.6x	↗																																																																								
4:	9.5	↘																																																																								
5:	9.5	↑																																																																								
6:	10.7x	↗																																																																								
7:	10.6x	↘																																																																								
8:	9.9	↖																																																																								
9:	10.1	↖																																																																								
10:	9.6	↑																																																																								
Series	95 (3x)																																																																									
	95 (3x)																																																																									
11:	9.9	↖																																																																								
12:	9.6	↗																																																																								
13:	10.2	↖																																																																								
14:	10.4x	↘																																																																								
15:	9.7	↑																																																																								
16:	10.4x	↗																																																																								
17:	9.4	↗																																																																								
18:	10.7x	↗																																																																								
19:	9.8	↘																																																																								
20:	10.5x	↘																																																																								
Series	95 (4x)																																																																									
	190 (7x)																																																																									
60 Shots																																																																										
	<table border="1" style="width:100%; border-collapse: collapse;"> <tr><td>21:</td><td>10.2</td><td>↘</td></tr> <tr><td>22:</td><td>9.5</td><td>↘</td></tr> <tr><td>23:</td><td>9.9</td><td>↗</td></tr> <tr><td>24:</td><td>10.3</td><td>↖</td></tr> <tr><td>25:</td><td>9.1</td><td>↘</td></tr> <tr><td>26:</td><td>10.1</td><td>↘</td></tr> <tr><td>27:</td><td>9.8</td><td>↑</td></tr> <tr><td>28:</td><td>9.6</td><td>↗</td></tr> <tr><td>29:</td><td>9.0</td><td>↑</td></tr> <tr><td>30:</td><td>9.6</td><td>↗</td></tr> <tr><td>Series</td><td>93 (0x)</td><td></td></tr> <tr><td></td><td>283 (7x)</td><td></td></tr> </table>	21:	10.2	↘	22:	9.5	↘	23:	9.9	↗	24:	10.3	↖	25:	9.1	↘	26:	10.1	↘	27:	9.8	↑	28:	9.6	↗	29:	9.0	↑	30:	9.6	↗	Series	93 (0x)			283 (7x)		<table border="1" style="width:100%; border-collapse: collapse;"> <tr><td>31:</td><td>9.5</td><td>↘</td></tr> <tr><td>32:</td><td>7.8</td><td>↗</td></tr> <tr><td>33:</td><td>10.6x</td><td>↗</td></tr> <tr><td>34:</td><td>10.5x</td><td>↘</td></tr> <tr><td>35:</td><td>10.5x</td><td>↘</td></tr> <tr><td>36:</td><td>9.7</td><td>↗</td></tr> <tr><td>37:</td><td>10.3</td><td>↗</td></tr> <tr><td>38:</td><td>9.7</td><td>↘</td></tr> <tr><td>39:</td><td>8.8</td><td>↗</td></tr> <tr><td>40:</td><td>9.5</td><td>↘</td></tr> <tr><td>Series</td><td>91 (3x)</td><td></td></tr> <tr><td></td><td>374 (10x)</td><td></td></tr> </table>	31:	9.5	↘	32:	7.8	↗	33:	10.6x	↗	34:	10.5x	↘	35:	10.5x	↘	36:	9.7	↗	37:	10.3	↗	38:	9.7	↘	39:	8.8	↗	40:	9.5	↘	Series	91 (3x)			374 (10x)	
21:	10.2	↘																																																																								
22:	9.5	↘																																																																								
23:	9.9	↗																																																																								
24:	10.3	↖																																																																								
25:	9.1	↘																																																																								
26:	10.1	↘																																																																								
27:	9.8	↑																																																																								
28:	9.6	↗																																																																								
29:	9.0	↑																																																																								
30:	9.6	↗																																																																								
Series	93 (0x)																																																																									
	283 (7x)																																																																									
31:	9.5	↘																																																																								
32:	7.8	↗																																																																								
33:	10.6x	↗																																																																								
34:	10.5x	↘																																																																								
35:	10.5x	↘																																																																								
36:	9.7	↗																																																																								
37:	10.3	↗																																																																								
38:	9.7	↘																																																																								
39:	8.8	↗																																																																								
40:	9.5	↘																																																																								
Series	91 (3x)																																																																									
	374 (10x)																																																																									
60 Shots																																																																										
	<table border="1" style="width:100%; border-collapse: collapse;"> <tr><td>41:</td><td>9.9</td><td>↗</td></tr> <tr><td>42:</td><td>9.7</td><td>↘</td></tr> <tr><td>43:</td><td>10.0</td><td>↑</td></tr> <tr><td>44:</td><td>10.1</td><td>↘</td></tr> <tr><td>45:</td><td>10.2</td><td>↘</td></tr> <tr><td>46:</td><td>10.3</td><td>↗</td></tr> <tr><td>47:</td><td>10.1</td><td>↑</td></tr> <tr><td>48:</td><td>9.6</td><td>↖</td></tr> <tr><td>49:</td><td>10.0</td><td>↑</td></tr> <tr><td>50:</td><td>9.3</td><td>↗</td></tr> <tr><td>Series</td><td>96 (0x)</td><td></td></tr> <tr><td></td><td>470 (10x)</td><td></td></tr> </table>	41:	9.9	↗	42:	9.7	↘	43:	10.0	↑	44:	10.1	↘	45:	10.2	↘	46:	10.3	↗	47:	10.1	↑	48:	9.6	↖	49:	10.0	↑	50:	9.3	↗	Series	96 (0x)			470 (10x)		<table border="1" style="width:100%; border-collapse: collapse;"> <tr><td>51:</td><td>9.8</td><td>↖</td></tr> <tr><td>52:</td><td>10.2</td><td>↘</td></tr> <tr><td>53:</td><td>9.1</td><td>↘</td></tr> <tr><td>54:</td><td>9.6</td><td>↖</td></tr> <tr><td>55:</td><td>10.2</td><td>↗</td></tr> <tr><td>56:</td><td>9.5</td><td>↖</td></tr> <tr><td>57:</td><td>8.9</td><td>↑</td></tr> <tr><td>58:</td><td>9.5</td><td>↑</td></tr> <tr><td>59:</td><td>10.0</td><td>↘</td></tr> <tr><td>60:</td><td>9.9</td><td>↖</td></tr> <tr><td>Series</td><td>92 (0x)</td><td></td></tr> <tr><td></td><td>562 (10x)</td><td></td></tr> </table>	51:	9.8	↖	52:	10.2	↘	53:	9.1	↘	54:	9.6	↖	55:	10.2	↗	56:	9.5	↖	57:	8.9	↑	58:	9.5	↑	59:	10.0	↘	60:	9.9	↖	Series	92 (0x)			562 (10x)	
41:	9.9	↗																																																																								
42:	9.7	↘																																																																								
43:	10.0	↑																																																																								
44:	10.1	↘																																																																								
45:	10.2	↘																																																																								
46:	10.3	↗																																																																								
47:	10.1	↑																																																																								
48:	9.6	↖																																																																								
49:	10.0	↑																																																																								
50:	9.3	↗																																																																								
Series	96 (0x)																																																																									
	470 (10x)																																																																									
51:	9.8	↖																																																																								
52:	10.2	↘																																																																								
53:	9.1	↘																																																																								
54:	9.6	↖																																																																								
55:	10.2	↗																																																																								
56:	9.5	↖																																																																								
57:	8.9	↑																																																																								
58:	9.5	↑																																																																								
59:	10.0	↘																																																																								
60:	9.9	↖																																																																								
Series	92 (0x)																																																																									
	562 (10x)																																																																									

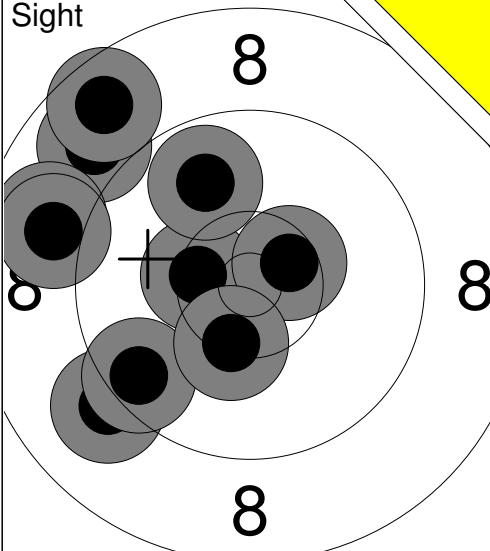
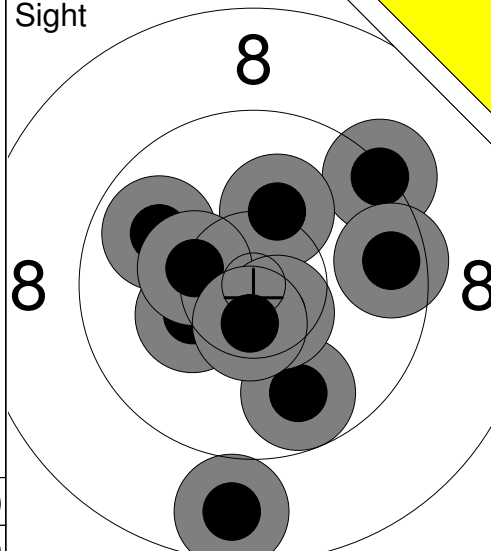
<p>Sight</p> 	<p>1: 8.9 ↗ 2: 9.1 ↙ 3: 10.4x ← 4: 10.5x → 5: 8.7 ↗ 6: 8.9 ← 7: 9.5 ↙ 8: 10.3 ↓ 9: 9.9 ↗ 10: 8.9 ←</p> <p>Series 89 (2x) 0 (0x)</p>	<p>Sight</p> 	<p>11: 9.9 ↖ 12: 10.3 ← 13: 9.3 ↗ 14: 10.2 ↑ 15: 9.8 ↓ 16: 10.3 ← 17: 8.7 ↓ 18: 10.6x ↓ 19: 9.6 → 20: 10.6x ↓</p> <p>Series 94 (2x) 0 (0x)</p>
---	---	---	--

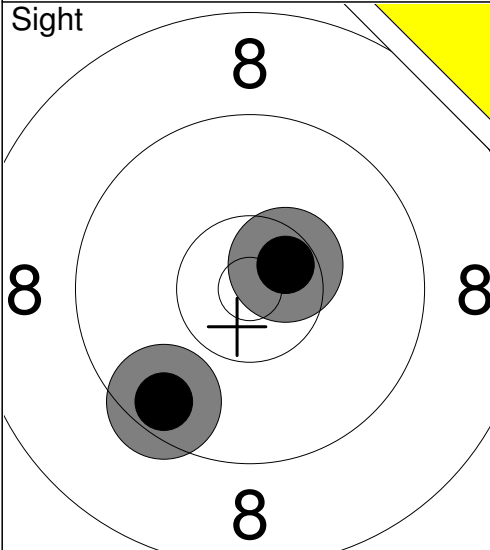
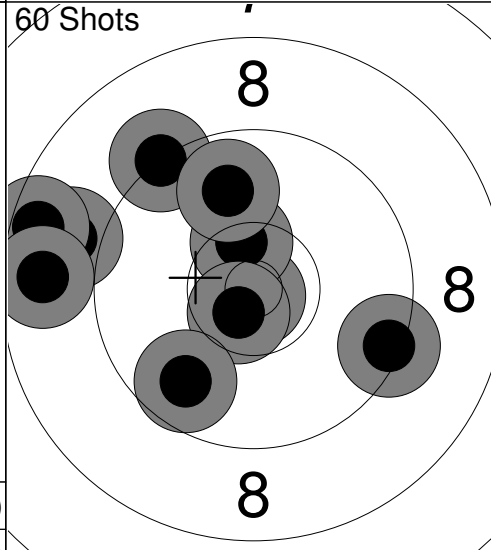
<p>Sight</p> 	<p>21: 10.5x → 22: 9.6 ↙</p> <p>Series 19 (1x) 0 (0x)</p>	<p>60 Shots</p> 	<p>1: 10.9x ↓ 2: 10.4x ↑ 3: 9.2 ↗ 4: 9.9 ↑ 5: 8.9 ← 6: 8.5 ← 7: 9.4 → 8: 8.7 ← 9: 10.7x ↓ 10: 9.7 ↙</p> <p>Series 90 (3x) 90 (3x)</p>
--	---	---	---

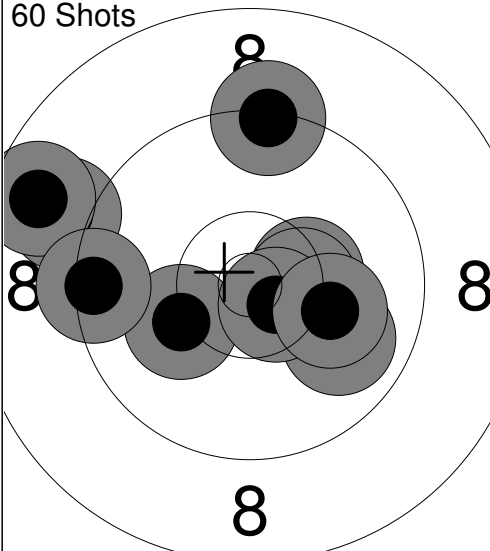
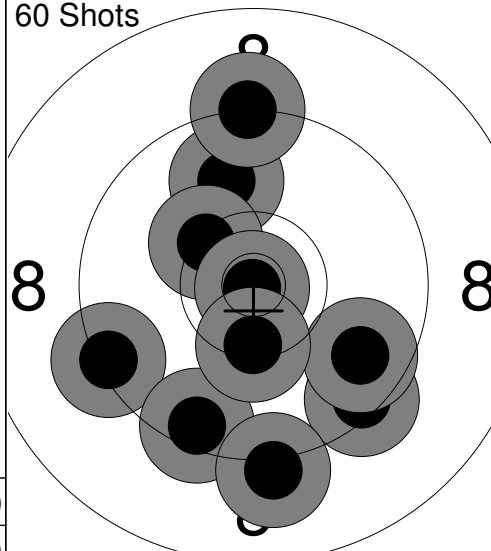
<p>60 Shots</p> 	<p>11: 10.4x → 12: 9.9 ↘ 13: 9.0 ← 14: 8.7 ← 15: 10.4x → 16: 9.3 ↑ 17: 10.2 ← 18: 10.6x ↘ 19: 9.4 ← 20: 10.1 →</p> <p>Series 94 (3x) 184 (6x)</p>	<p>60 Shots</p> 	<p>21: 9.9 ↑ 22: 9.4 ↘ 23: 9.3 ← 24: 9.2 ↑ 25: 9.7 ↘ 26: 10.3 ↗ 27: 10.9x ↓ 28: 9.5 ↓ 29: 9.1 ↓ 30: 10.4x ↓</p> <p>Series 93 (2x) 277 (8x)</p>
--	---	--	--

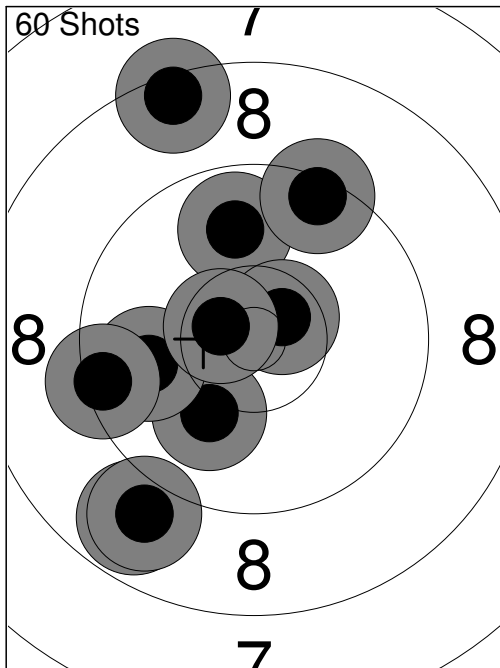

31:	8.8	↘
32:	8.9	↘
33:	8.4	↗
34:	10.1	↘
35:	9.9	↗
36:	10.6x	↗
37:	9.4	↗
38:	9.9	←
39:	10.6x	↙
40:	9.4	←
Series	90 (2x)	
		367 (10x)

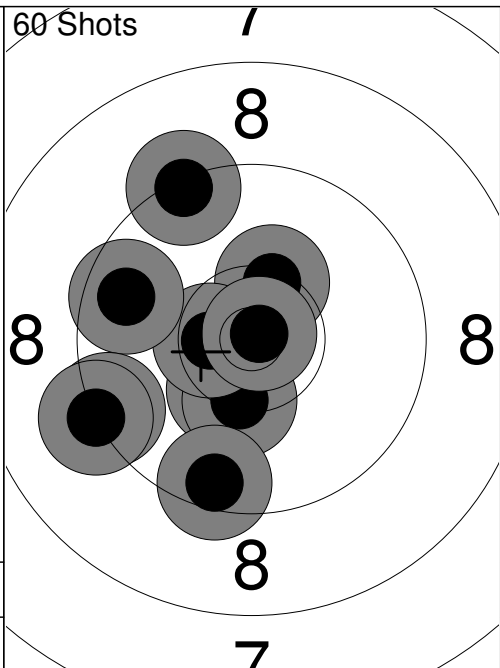

41:	10.4x	↗
42:	10.4x	↘
43:	10.3	↘
44:	10.5x	↙
45:	9.6	←
46:	9.4	↙
47:	9.3	↗
48:	10.9x	↗
49:	9.5	↘
50:	9.2	↙
Series	95 (4x)	
		462 (14x)

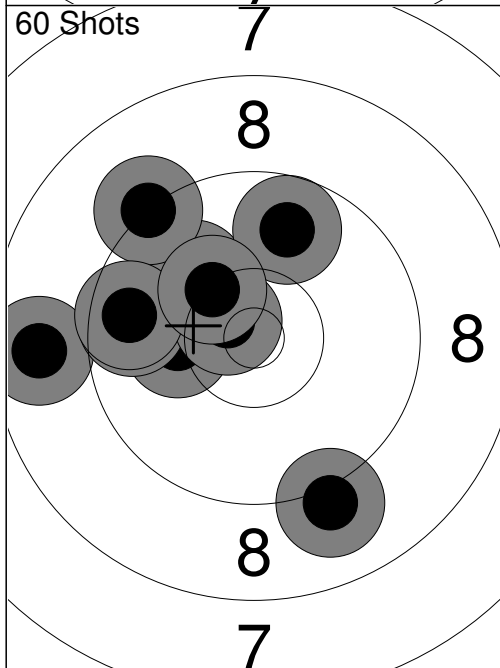

51:	8.7	←
52:	10.0	↗
53:	9.1	↘
54:	10.2	←
55:	9.7	←
56:	9.2	↗
57:	10.6x	↙
58:	9.6	←
59:	9.8	↗
60:	10.3	↘
Series	93 (1x)	
		555 (15x)

Relay **2** Lane **1** **HUANG Margaret**

2023 SFC Pistol Nationals BC SJ WP

15.07.2023 PN23AP-Q-1 Alberta Handgun Association

Comment Signature

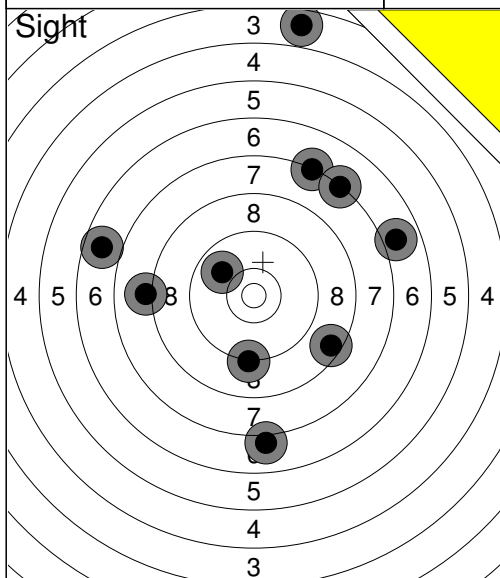

1:	3.6	↑
2:	7.0	↓
3:	7.2	↑
4:	6.9	→
5:	8.5	↘
6:	6.7	←
7:	7.3	↗
8:	9.9	↖
9:	8.1	←
10:	9.2	↓
Series	70 (0x)	
	0 (0x)	

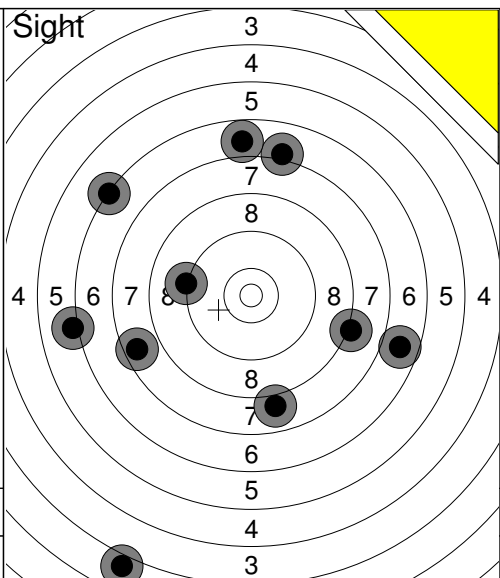

11:	6.1	←
12:	7.6	↙
13:	7.1	↑
14:	8.1	→
15:	6.8	↑
16:	7.9	↓
17:	6.7	→
18:	2.9	↓
19:	9.2	←
20:	6.3	↖
Series	64 (0x)	
	0 (0x)	

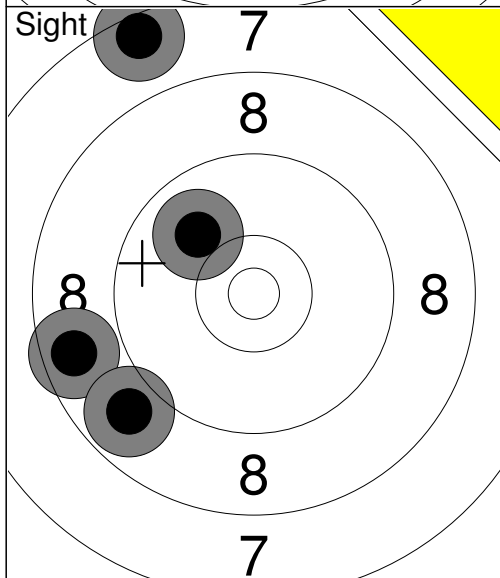

21:	8.6	←
22:	8.8	↙
23:	10.0	↗
24:	7.5	↑
Series	33 (0x)	
	0 (0x)	

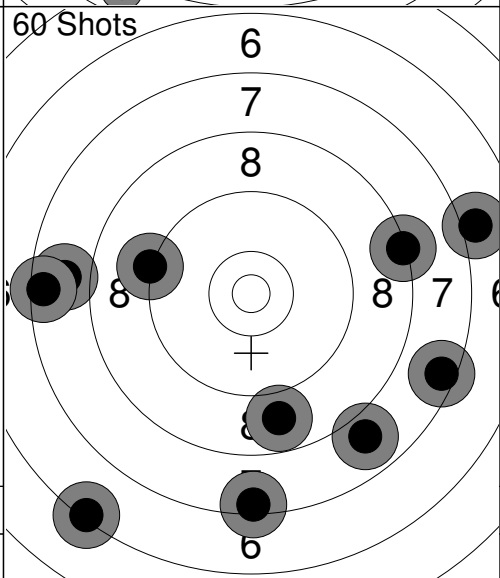

1:	7.8	←
2:	7.0	→
3:	7.4	↓
4:	7.4	←
5:	8.3	→
6:	8.8	↓
7:	6.3	↙
8:	9.2	←
9:	7.9	↓
10:	7.5	→
Series	73 (0x)	
	73 (0x)	

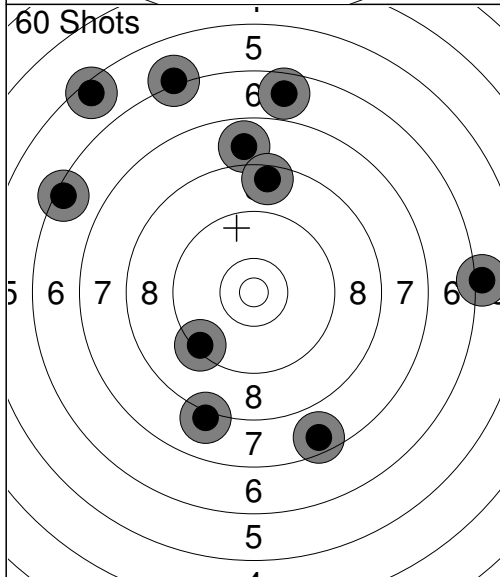

11:	7.8	↑
12:	9.3	↙
13:	7.6	↓
14:	6.4	↖
15:	8.1	↓
16:	6.1	→
17:	6.1	↑
18:	6.7	↑
19:	8.5	↑
20:	5.5	↖
Series	68 (0x)	
	141 (0x)	

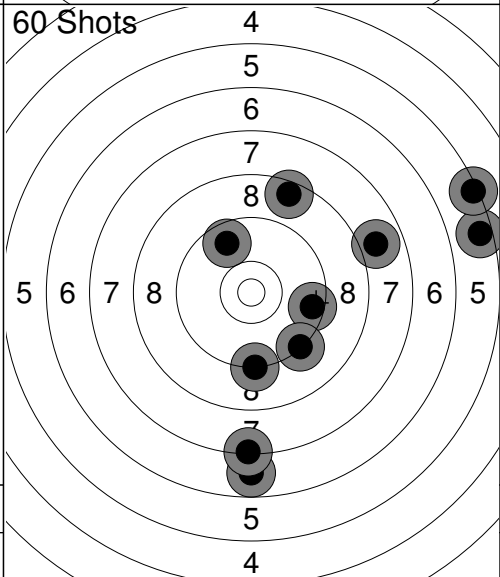

21:	9.2	↓
22:	5.5	→
23:	5.3	↗
24:	9.7	↑
25:	8.5	↑
26:	9.5	→
27:	6.8	↓
28:	7.3	↓
29:	9.3	↘
30:	7.9	↗
Series	74 (0x)	
	215 (0x)	

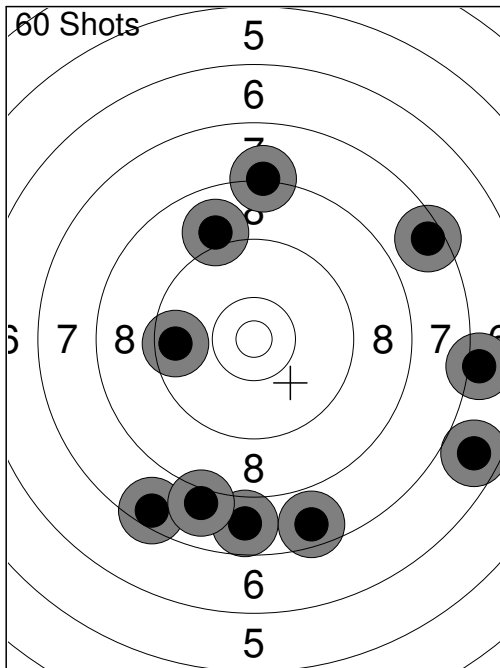

31:	6.7	↘
32:	9.6	←
33:	7.8	↓
34:	7.5	↘
35:	8.0	↓
36:	7.6	↓
37:	7.0	→
38:	7.5	↗
39:	9.0	↑
40:	8.2	↑

Series	75 (0x)
	290 (0x)

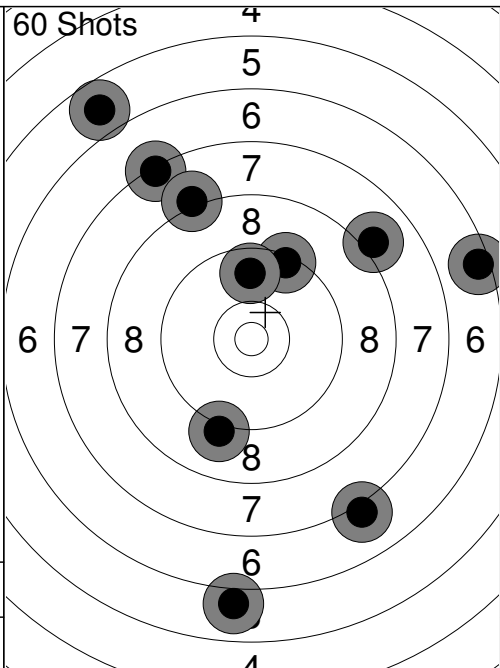

41:	5.8	↗
42:	7.3	↗
43:	8.1	↗
44:	9.4	↗
45:	8.0	↗
46:	6.4	→
47:	5.9	↓
48:	7.1	↘
49:	9.1	↓
50:	9.7	↑

Series	73 (0x)
	363 (0x)

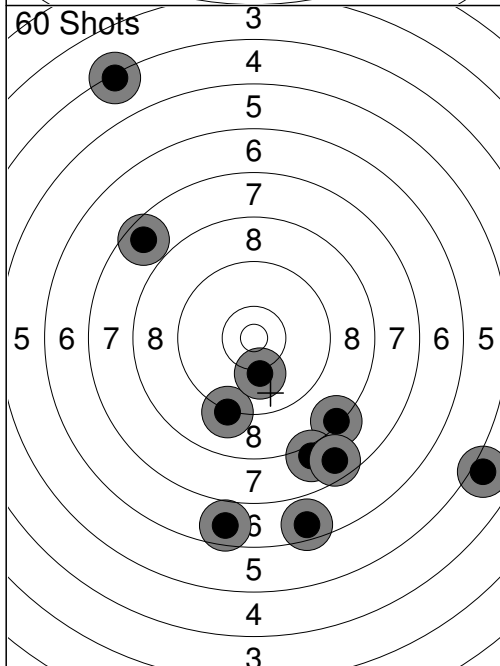

51:	4.3	↗
52:	9.2	↓
53:	6.6	↓
54:	8.3	↘
55:	7.6	↗
56:	5.0	↘
57:	10.1	↓
58:	8.0	↓
59:	6.7	↓
60:	7.6	↘

Series	70 (0x)
	433 (0x)

Empty space for notes or additional data.

Empty space for notes or additional data.

Relay 2	Lane 2	XU Kitty
-------------------	------------------	-----------------

2023 SFC Pistol Nationals	BC	SJ	WP
---------------------------	----	----	----

15.07.2023	PN23AP-Q-1	Alberta Handgun Association
------------	------------	-----------------------------

Comment	Signature
---------	-----------

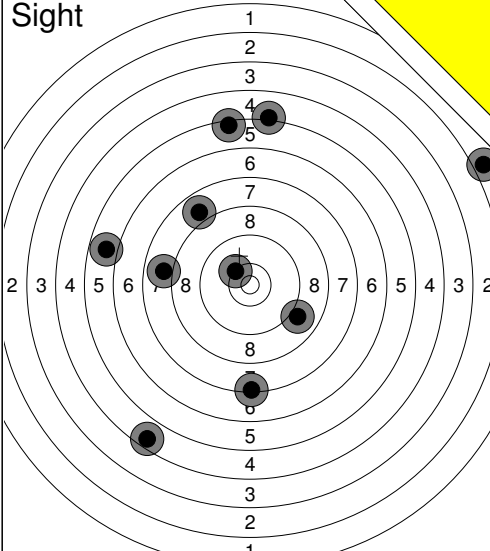
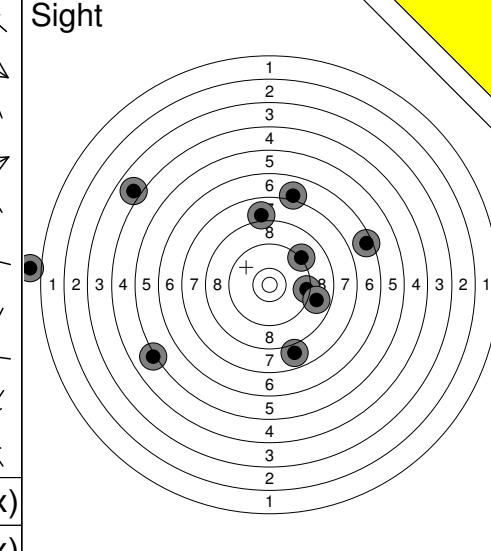
<p>Sight</p> 	<p>1: 10.3 ↖ 2: 9.0 ➤ 3: 5.1 ↑ 4: 1.9 ➤ 5: 5.4 ↑ 6: 5.8 ← 7: 7.3 ↓ 8: 7.9 ← 9: 4.5 ↙ 10: 7.9 ↖</p> <p>Series 60 (0x) 0 (0x)</p>	<p>Sight</p> 	<p>11: 8.0 ↑ 12: 9.2 ↗ 13: 7.9 ↓ 14: 7.0 ↑ 15: 5.2 ↙ 16: 9.4 ➤ 17: 8.9 ➤ 18: 6.5 ➤ 19: 3.9 ↖ 20: 0.0 ←</p> <p>Series 62 (0x) 0 (0x)</p>
---	---	---	---

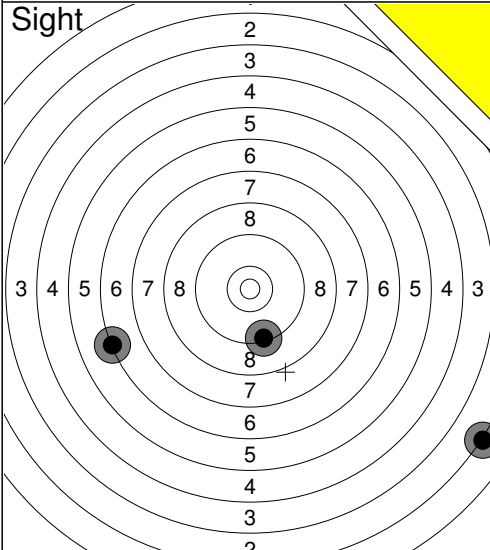
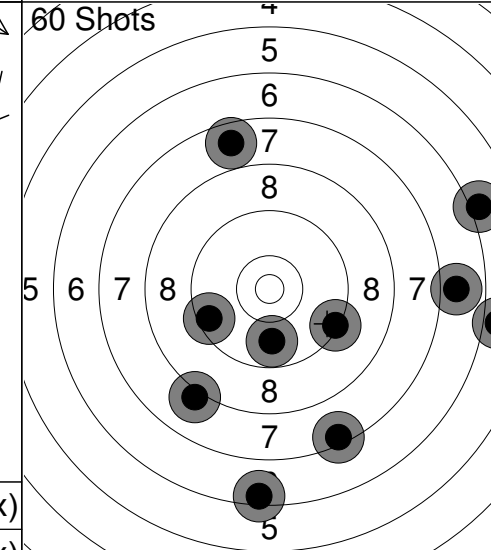
<p>Sight</p> 	<p>21: 2.2 ➤ 22: 9.3 ↓ 23: 6.3 ←</p> <p>Series 17 (0x) 0 (0x)</p>	<p>60 Shots</p> 	<p>1: 9.8 ↓ 2: 7.4 ↓ 3: 6.0 ➤ 4: 7.7 ↑ 5: 5.9 ➤ 6: 6.9 ➤ 7: 9.5 ← 8: 8.1 ↙ 9: 9.3 ➤ 10: 6.4 ↓</p> <p>Series 72 (0x) 72 (0x)</p>
--	---	---	---

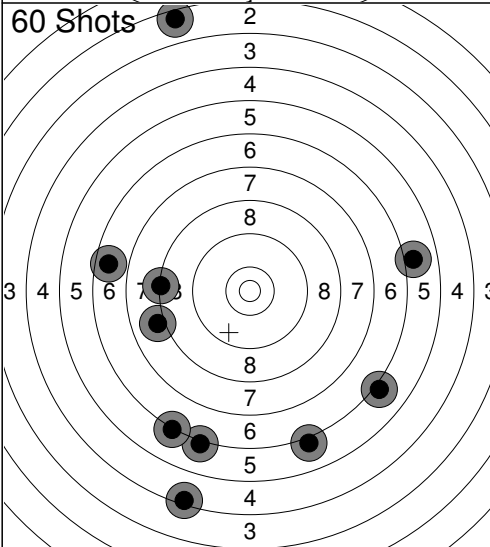
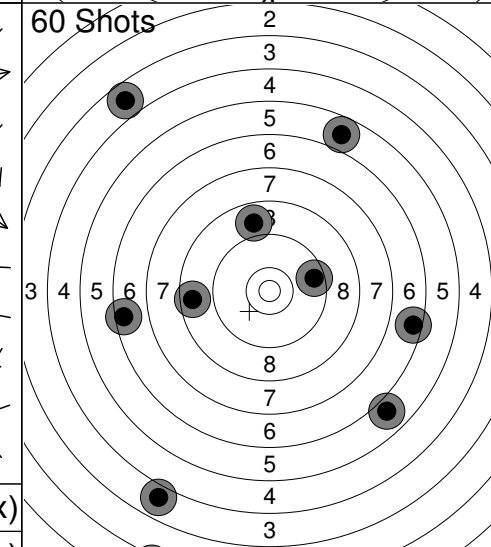
<p>60 Shots</p> 	<p>11: 6.1 ↓ 12: 6.0 ➤ 13: 4.4 ↓ 14: 6.1 ↓ 15: 6.1 ➤ 16: 8.3 ← 17: 6.6 ← 18: 6.2 ↙ 19: 8.0 ← 20: 2.5 ↑</p> <p>Series 58 (0x) 130 (0x)</p>	<p>60 Shots</p> 	<p>21: 6.5 ➤ 22: 9.5 ➤ 23: 8.8 ↑ 24: 2.0 ↓ 25: 6.5 ← 26: 5.7 ↑ 27: 3.9 ↓ 28: 8.6 ← 29: 3.7 ↖ 30: 5.9 ↙</p> <p>Series 55 (0x) 185 (0x)</p>
--	---	--	---

60 Shots

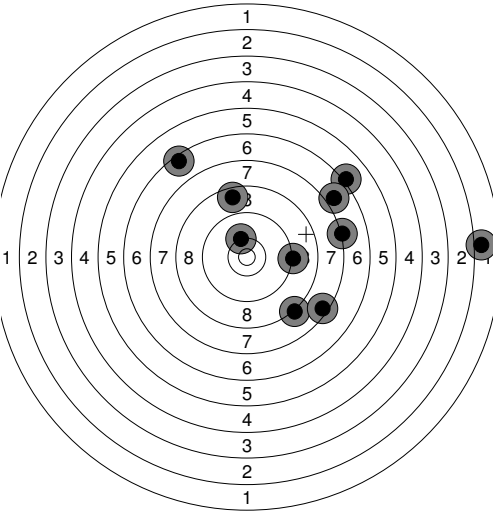

- 31: 8.2 ↘
- 32: 9.2 →
- 33: 8.6 ↑
- 34: 2.0 →
- 35: 6.1 ↗
- 36: 7.4 ↘
- 37: 7.2 →
- 38: 10.2 ↑
- 39: 6.9 ↗
- 40: 6.5 ↖

Series 69 (0x)
254 (0x)

60 Shots

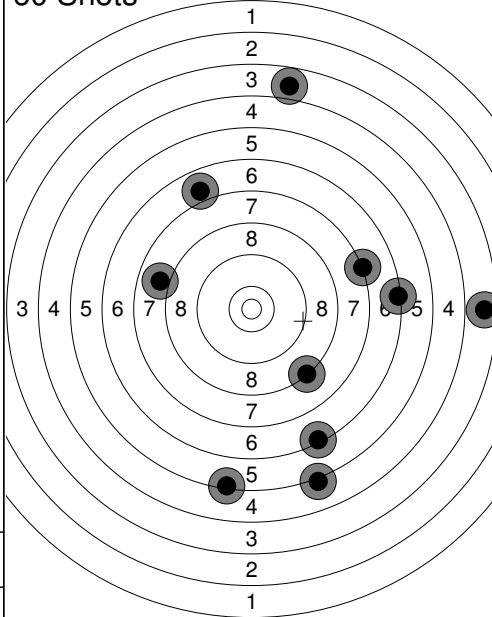

- 41: 6.3 ↘
- 42: 3.8 ↑
- 43: 5.1 ↘
- 44: 6.9 ↗
- 45: 8.3 ↘
- 46: 5.3 ↓
- 47: 7.9 ←
- 48: 7.2 →
- 49: 3.6 →
- 50: 6.3 →

Series 56 (0x)
310 (0x)

60 Shots

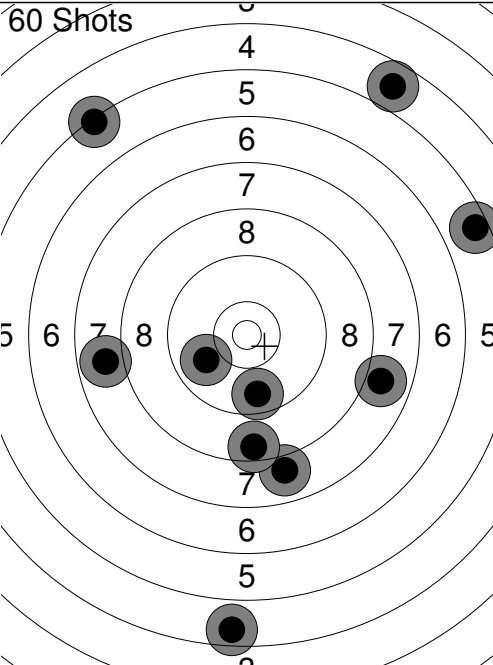

- 51: 5.5 ↗
- 52: 4.7 ↗
- 53: 7.9 ←
- 54: 7.9 ↓
- 55: 9.7 ↓
- 56: 5.3 ↗
- 57: 8.5 ↓
- 58: 4.6 ↓
- 59: 9.9 ↖
- 60: 7.9 →

Series 65 (0x)
375 (0x)

Relay **2** Lane **3** **ZHENG Tingxi**

2023 SFC Pistol Nationals BC SJ WP

15.07.2023 PN23AP-Q-1 Alberta Handgun Association

Comment Signature

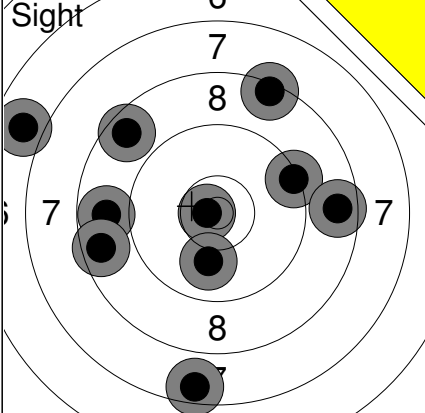
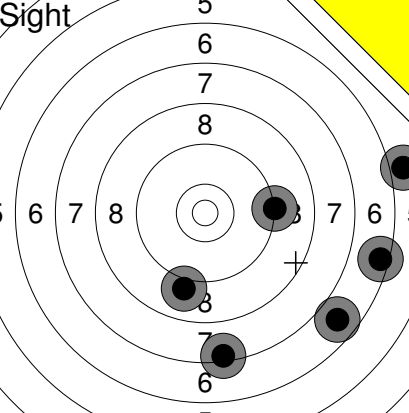
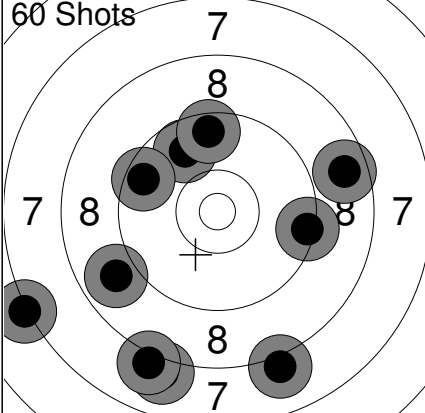
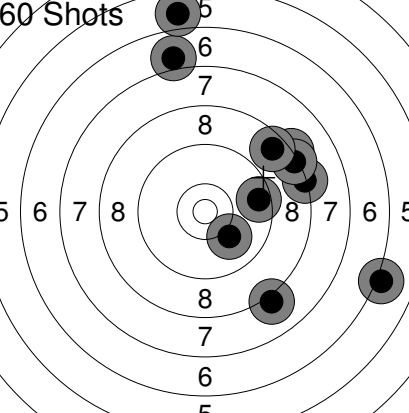
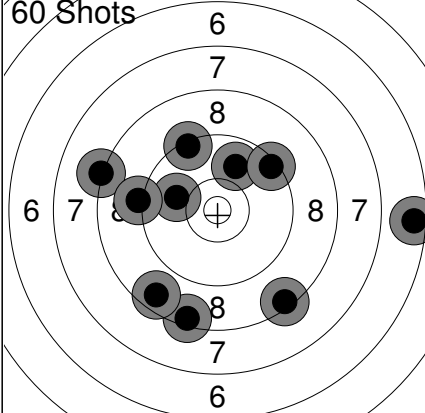
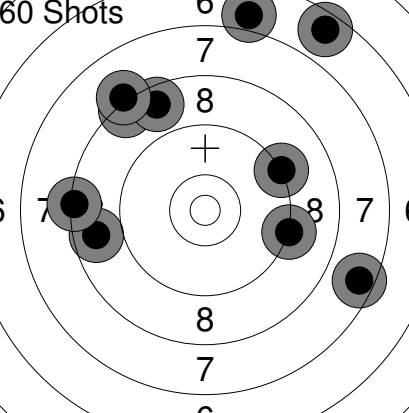
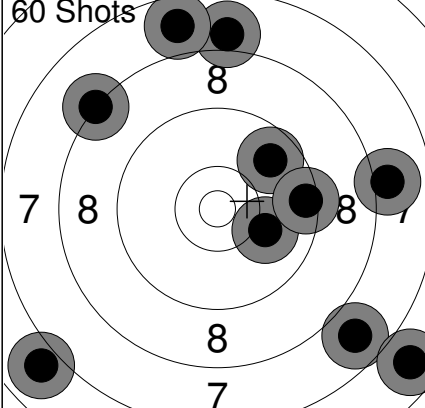
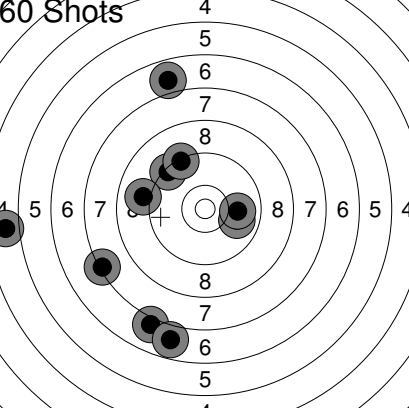
<p>Sight</p> 	<p>1: 7.6 ↓ 2: 6.8 ↖ 3: 8.4 ↗ 4: 8.8 ← 5: 10.7x ← 6: 8.6 ↗ 7: 8.6 ← 8: 10.0 ↓ 9: 9.3 → 10: 8.6 →</p> <p>Series 82 (1x) 0 (0x)</p>	<p>Sight</p> 	<p>11: 6.4 → 12: 5.9 → 13: 7.4 ↓ 14: 9.2 → 15: 6.7 ↘ 16: 9.0 ↓</p> <p>Series 42 (0x) 0 (0x)</p>
<p>60 Shots</p> 	<p>1: 8.0 ↓ 2: 9.8 ↗ 3: 8.9 ↖ 4: 8.6 → 5: 8.1 ↓ 6: 8.0 ↓ 7: 9.5 ↗ 8: 7.2 ← 9: 9.4 → 10: 9.6 ↑</p> <p>Series 83 (0x) 83 (0x)</p>	<p>60 Shots</p> 	<p>11: 10.1 ↘ 12: 8.3 → 13: 8.2 ↗ 14: 6.9 ↑ 15: 8.3 ↗ 16: 8.1 ↓ 17: 6.1 → 18: 9.5 → 19: 5.8 ↑ 20: 8.6 ↗</p> <p>Series 76 (0x) 159 (0x)</p>
<p>60 Shots</p> 	<p>21: 8.2 ← 22: 8.4 ↓ 23: 9.4 ↗ 24: 10.0 ← 25: 8.4 ↓ 26: 8.6 ↖ 27: 9.1 ← 28: 9.9 ↑ 29: 6.5 → 30: 9.4 ↗</p> <p>Series 84 (0x) 243 (0x)</p>	<p>60 Shots</p> 	<p>31: 6.9 ↑ 32: 9.2 → 33: 8.4 ↗ 34: 9.2 ↗ 35: 8.6 ↑ 36: 8.7 ← 37: 8.3 ← 38: 8.1 ↗ 39: 6.6 ↗ 40: 7.5 →</p> <p>Series 77 (0x) 320 (0x)</p>
<p>60 Shots</p> 	<p>41: 10.1 → 42: 8.0 → 43: 8.2 ↗ 44: 7.7 ↓ 45: 6.7 ↓ 46: 6.9 ↖ 47: 8.0 ↑ 48: 7.7 ↑ 49: 9.7 ↗ 50: 9.4 →</p> <p>Series 78 (0x) 398 (0x)</p>	<p>60 Shots</p> 	<p>51: 9.3 ↖ 52: 9.9 → 53: 4.8 ← 54: 9.0 ← 55: 7.0 ↓ 56: 9.9 → 57: 7.3 ↖ 58: 9.3 ↗ 59: 6.8 ↓ 60: 6.9 ↑</p> <p>Series 75 (0x) 473 (0x)</p>

Relay 2	Lane 4	YIN Jinxi
-------------------	------------------	------------------

2023 SFC Pistol Nationals	BC	SJ	WP
---------------------------	----	----	----

15.07.2023	PN23AP-Q-1	Alberta Handgun Association
------------	------------	-----------------------------

Comment	Signature
---------	-----------

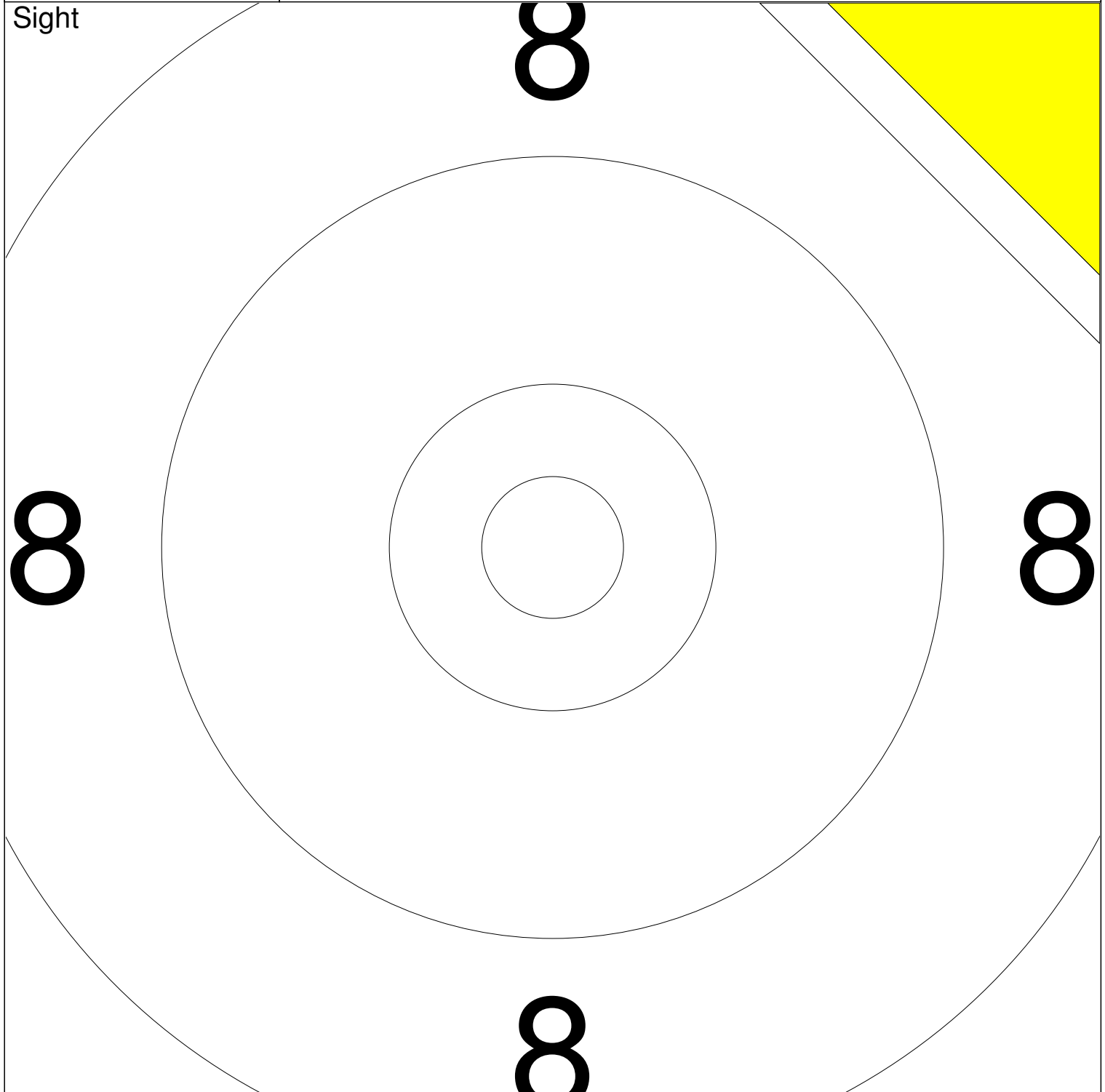

	Series	0 (0x)
		0 (0x)

Relay **2** Lane **5** **ZHANG Sissi yinhan**

2023 SFC Pistol Nationals BC SJ WP

15.07.2023 PN23AP-Q-1 Alberta Handgun Association

Comment Signature

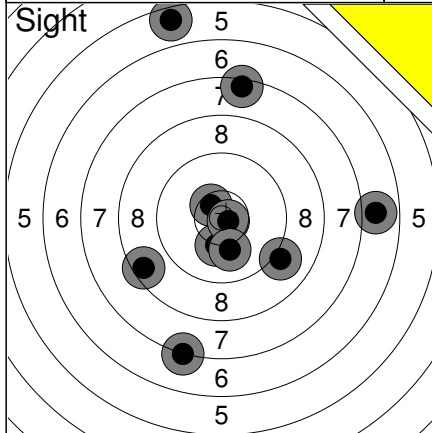

1:	10.5x	↖
2:	7.4	↑
3:	10.2	↓
4:	8.5	←
5:	10.8x	→
6:	7.2	↓
7:	10.1	↓
8:	9.1	→
9:	6.9	→
10:	5.5	↑
Series	82 (2x)	
	0 (0x)	

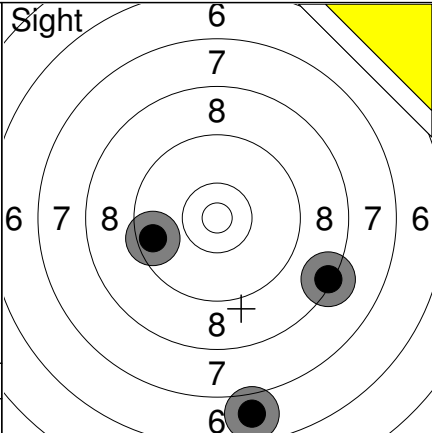

11:	9.6	←
12:	6.8	↓
13:	8.3	→
Series	23 (0x)	
	0 (0x)	

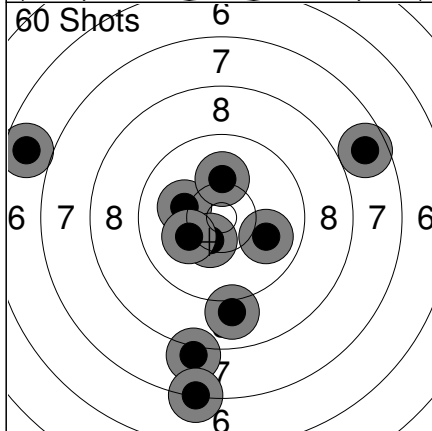

1:	8.0	↓
2:	6.7	←
3:	10.2	←
4:	10.1	↑
5:	10.4x	↓
6:	9.0	↓
7:	10.0	→
8:	7.7	→
9:	10.2	←
10:	7.2	↓
Series	87 (1x)	
	87 (1x)	

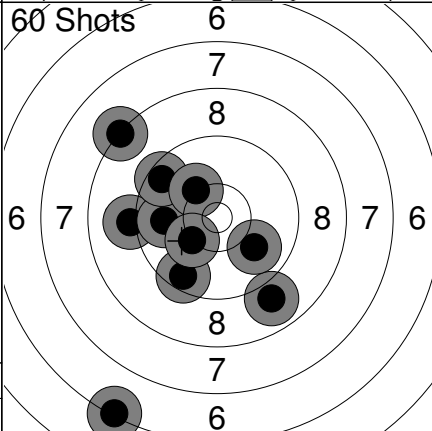

11:	8.9	↓
12:	8.2	↗
13:	6.3	↓
14:	9.1	←
15:	9.8	←
16:	9.5	↓
17:	10.0	↓
18:	9.5	↗
19:	10.2	↗
20:	10.2	↙
Series	88 (0x)	
	175 (1x)	

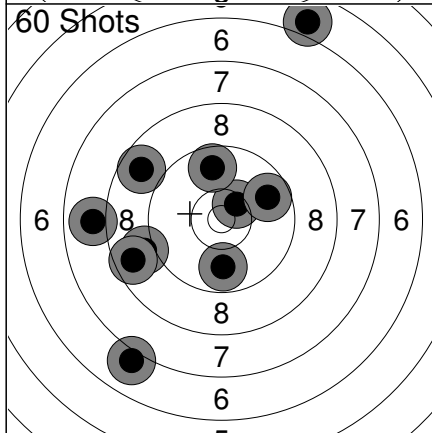

21:	10.4x	↗
22:	9.8	→
23:	9.0	←
24:	8.7	↖
25:	9.8	↓
26:	7.9	←
27:	7.0	↓
28:	5.9	↑
29:	8.7	←
30:	9.7	↑
Series	81 (1x)	
	256 (2x)	

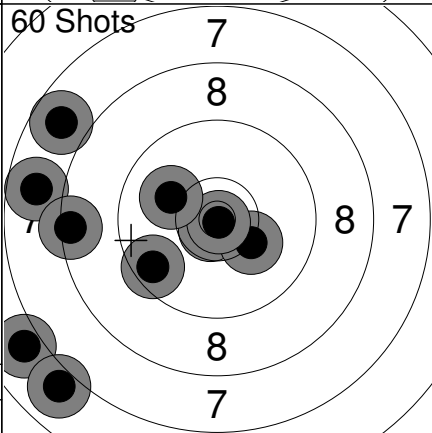

31:	7.8	←
32:	10.7x	↓
33:	10.2	↓
34:	10.9x	↓
35:	7.8	↗
36:	9.6	↙
37:	6.9	↙
38:	8.4	←
39:	6.9	↙
40:	10.1	↖
Series	83 (2x)	
	339 (4x)	

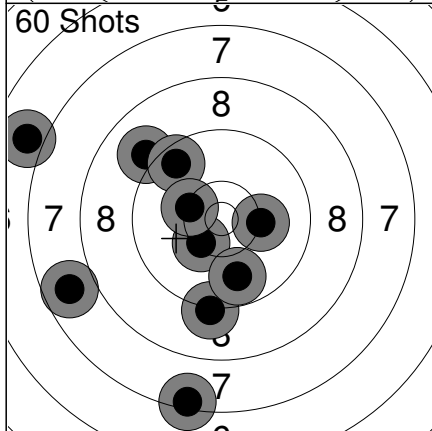

41:	9.1	↖
42:	9.2	↓
43:	9.6	↗
44:	10.3	↙
45:	10.2	→
46:	6.9	↖
47:	7.7	←
48:	10.3	←
49:	7.4	↓
50:	9.8	↓
Series	86 (0x)	
	425 (4x)	

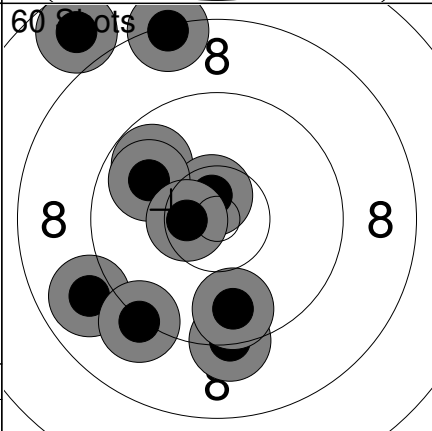

51:	9.8	↖
52:	9.3	↓
53:	9.7	↓
54:	8.3	↑
55:	10.6x	↑
56:	7.8	↗
57:	9.9	↗
58:	10.5x	←
59:	8.9	↙
60:	9.2	↙
Series	88 (2x)	
	513 (6x)	

Relay **2** Lane **6** **NICOL Sophia ting**

2023 SFC Pistol Nationals BC SJ WP

15.07.2023 PN23AP-Q-1 Alberta Handgun Association

Comment Signature

<p>Sight</p>	<p>1: 8.8 ↑ 2: 7.5 ↗ 3: 6.6 ← 4: 9.2 ↓ 5: 8.6 ← 6: 8.4 ↗ 7: 9.5 ↓ 8: 9.2 ↑ 9: 10.1 ↗ 10: 10.3 ↓</p> <p>Series 84 (0x) 0 (0x)</p>	<p>Sight</p>	<p>11: 9.5 → 12: 9.3 ↓ 13: 6.8 → 14: 7.5 ↗ 15: 9.7 ↓ 16: 9.5 ←</p> <p>Series 49 (0x) 0 (0x)</p>
<p>60 Shots</p>	<p>1: 6.9 ↓ 2: 9.5 ↗ 3: 9.1 ↑ 4: 5.5 ↗ 5: 9.4 ← 6: 9.2 ↗ 7: 8.2 ↓ 8: 10.6x ↓ 9: 7.8 ↓ 10: 9.0 ↓</p> <p>Series 81 (1x) 81 (1x)</p>	<p>60 Shots</p>	<p>11: 10.2 ↑ 12: 10.4x ↓ 13: 9.5 → 14: 9.2 ↓ 15: 8.8 ↓ 16: 8.6 → 17: 8.1 ↑ 18: 9.1 ← 19: 7.9 ← 20: 9.0 ←</p> <p>Series 87 (1x) 168 (2x)</p>
<p>60 Shots</p>	<p>21: 8.3 → 22: 9.8 ← 23: 8.6 → 24: 10.1 ← 25: 8.9 ↓ 26: 8.1 ↑ 27: 8.6 ↓ 28: 9.3 → 29: 8.9 ← 30: 8.9 ↑</p> <p>Series 84 (0x) 252 (2x)</p>	<p>60 Shots</p>	<p>31: 10.5x ↑ 32: 9.9 → 33: 8.8 ↑ 34: 9.7 ← 35: 8.6 ↓ 36: 8.1 ↑ 37: 9.8 → 38: 8.1 ← 39: 8.6 ↑ 40: 8.6 ←</p> <p>Series 85 (1x) 337 (3x)</p>
<p>60 Shots</p>	<p>41: 10.7x ↗ 42: 10.4x ↓ 43: 10.3 ↗ 44: 8.6 ↓ 45: 9.4 ↓ 46: 9.5 ↓ 47: 9.1 ↗ 48: 10.1 ↓ 49: 9.5 ← 50: 8.4 ↓</p> <p>Series 92 (2x) 429 (5x)</p>	<p>60 Shots</p>	<p>51: 9.1 ↑ 52: 9.1 ↑ 53: 9.1 ↗ 54: 8.7 ↓ 55: 9.4 ← 56: 10.4x ← 57: 9.7 ↓ 58: 6.8 ↓ 59: 10.3 ↓ 60: 10.1 ↑</p> <p>Series 89 (1x) 518 (6x)</p>

Relay **2** Lane **7** **HAN Kally**

2023 SFC Pistol Nationals BC JR WP

15.07.2023 PN23AP-Q-1 Alberta Handgun Association

Comment Signature

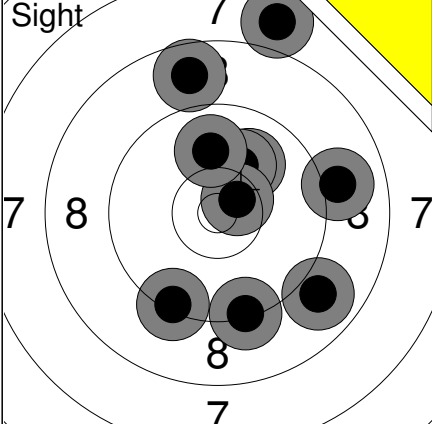
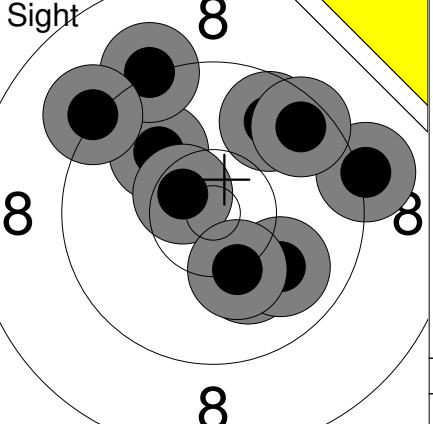
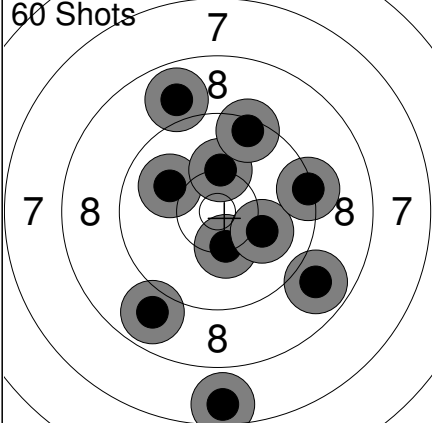
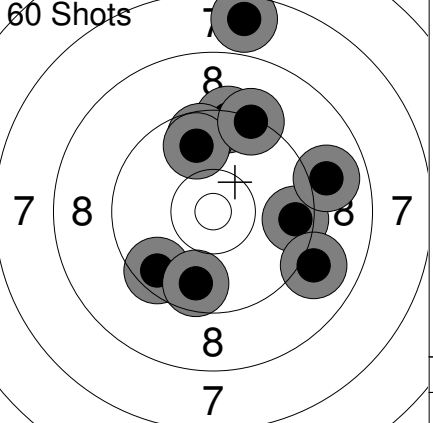
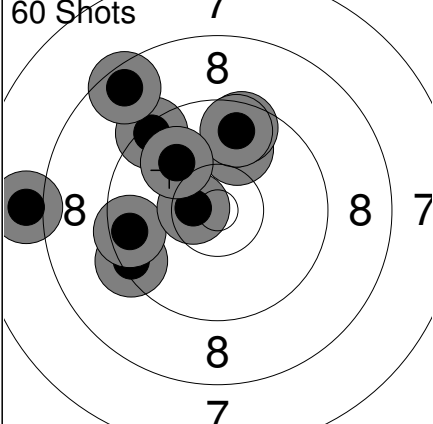
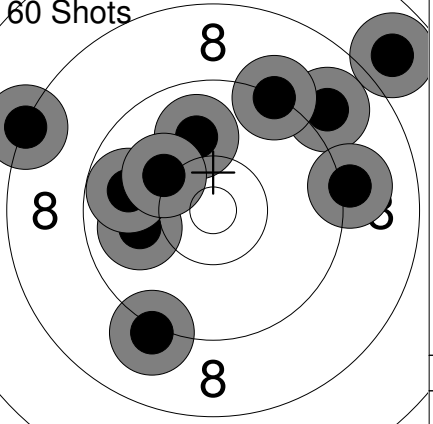
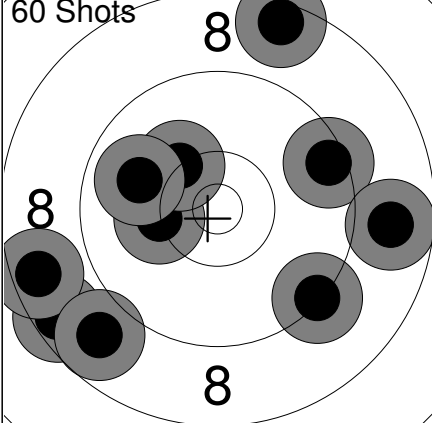
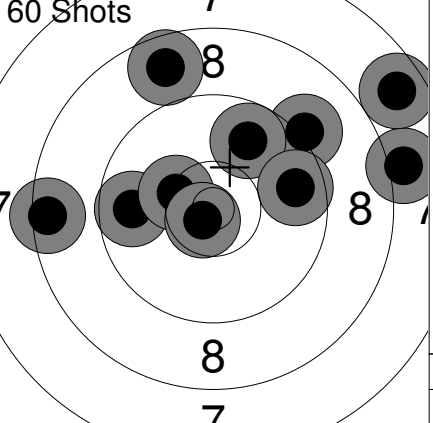
Sight		1: 9.0 → 2: 8.9 ↘ 3: 9.3 ↓ 4: 10.0 ↗ 5: 10.1 ↗ 6: 8.7 ↗ 7: 9.3 ↓ 8: 7.8 ↑ 9: 10.6x ↗ 10: 10.0 ↑	Sight		11: 9.2 → 12: 10.2 ↓ 13: 9.7 ↗ 14: 10.0 ↗ 15: 9.2 ↗ 16: 9.6 ↗ 17: 10.0 ↓ 18: 10.5x ↗ 19: 9.2 ↗ 20: 10.2 ↓
	Series	90 (1x) 0 (0x)		Series	95 (1x) 0 (0x)
60 Shots		1: 8.9 ↘ 2: 10.0 ↖ 3: 10.3 ↓ 4: 10.1 → 5: 7.6 ↓ 6: 9.3 → 7: 10.2 ↑ 8: 8.8 ↘ 9: 9.4 ↑ 10: 8.9 ↑	60 Shots		11: 9.5 → 12: 9.4 ↑ 13: 9.7 ↑ 14: 9.6 ↖ 15: 9.8 ↑ 16: 9.7 ↓ 17: 9.0 → 18: 9.3 ↑ 19: 7.6 ↑ 20: 8.9 →
	Series	89 (0x) 89 (0x)		Series	87 (0x) 176 (0x)
60 Shots		21: 9.4 ↖ 22: 9.4 ↗ 23: 10.0 ↑ 24: 9.6 ↑ 25: 8.6 ↗ 26: 8.0 ↖ 27: 9.7 ↑ 28: 9.5 ↖ 29: 10.6x ↖ 30: 10.0 ↗	60 Shots		31: 7.8 ↗ 32: 8.9 ↗ 33: 10.0 ↑ 34: 9.1 → 35: 8.2 ↖ 36: 9.1 ↓ 37: 10.0 ↖ 38: 9.3 ↑ 39: 9.8 ↖ 40: 10.2 ↖
	Series	91 (1x) 267 (1x)		Series	89 (0x) 356 (1x)
60 Shots		41: 9.4 → 42: 8.5 ↖ 43: 10.2 ↖ 44: 8.6 ↖ 45: 10.2 ↗ 46: 9.9 ↗ 47: 8.8 ↖ 48: 8.8 → 49: 9.3 ↓ 50: 8.5 ↑	60 Shots		51: 9.2 ↗ 52: 9.8 ↑ 53: 9.7 ↖ 54: 8.5 ↖ 55: 10.3 ↖ 56: 10.7x ↖ 57: 8.7 ↑ 58: 9.7 → 59: 8.0 → 60: 7.7 ↗
	Series	87 (0x) 443 (1x)		Series	87 (1x) 530 (2x)

Relay **2** Lane **8** **LIU Nina jia rui**

2023 SFC Pistol Nationals BC JR WP

15.07.2023 PN23AP-Q-1 Alberta Handgun Association

Comment Signature

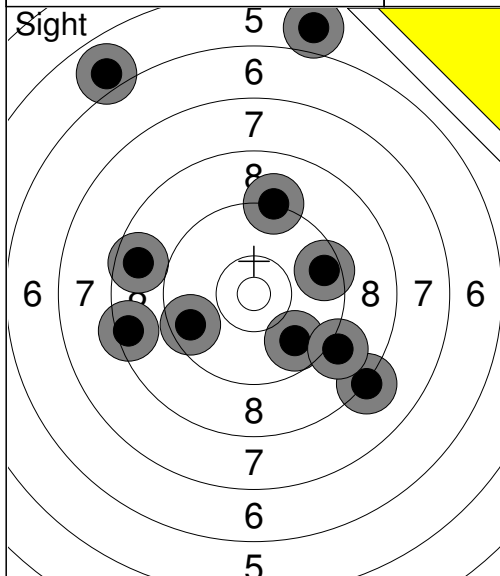

1:	8.7	←
2:	9.6	←
3:	9.2	↑
4:	5.9	↗
5:	8.5	←
6:	8.2	↘
7:	9.5	→
8:	5.8	↑
9:	9.8	↘
10:	9.0	↘
Series	79 (0x)	
	0 (0x)	

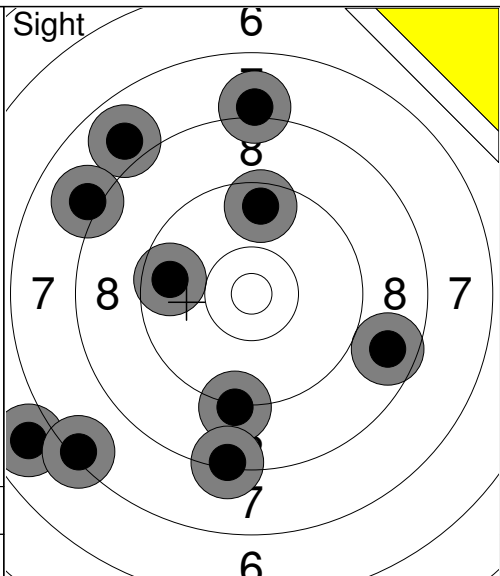

11:	9.2	↓
12:	8.3	↓
13:	7.9	↗
14:	6.8	←
15:	7.3	←
16:	8.1	↑
17:	9.7	←
18:	8.7	→
19:	9.6	↑
20:	8.0	←
Series	79 (0x)	
	0 (0x)	

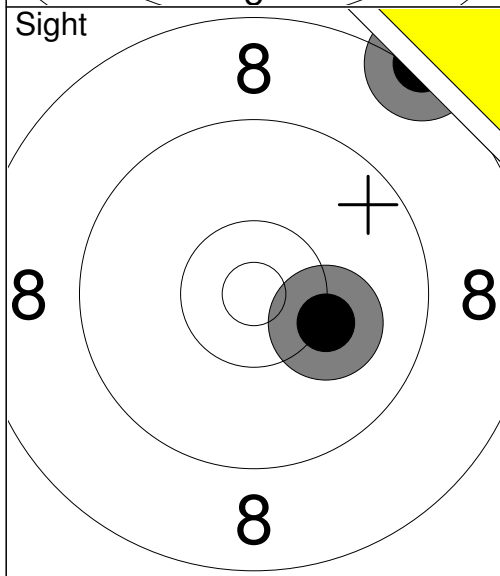

21:	8.1	↗
22:	10.2	→
Series	18 (0x)	
	0 (0x)	

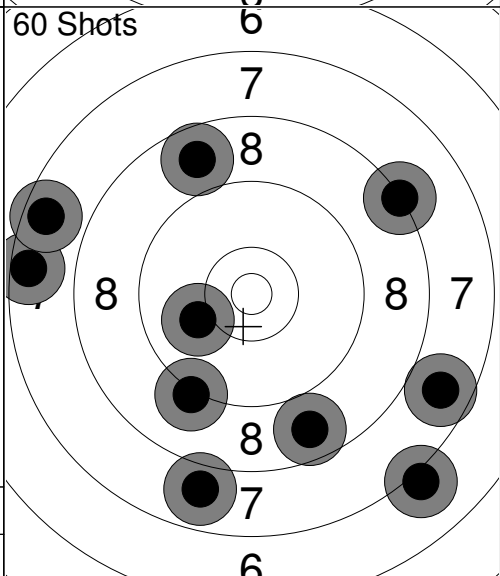

1:	7.5	←
2:	7.6	←
3:	7.9	↓
4:	8.2	↗
5:	8.7	↑
6:	8.7	↓
7:	9.2	↓
8:	10.0	←
9:	7.7	→
10:	7.1	↘
Series	78 (0x)	
	78 (0x)	

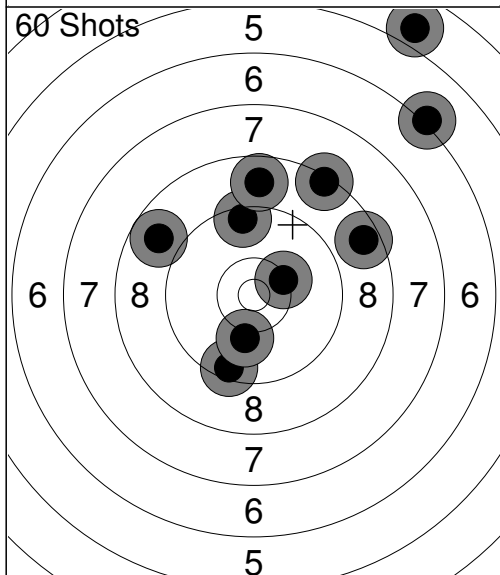

11:	9.4	↑
12:	8.8	↑
13:	8.8	←
14:	9.5	↓
15:	8.6	→
16:	10.1	↓
17:	4.9	↗
18:	8.4	↗
19:	6.2	↗
20:	10.3	↗
Series	80 (0x)	
	158 (0x)	

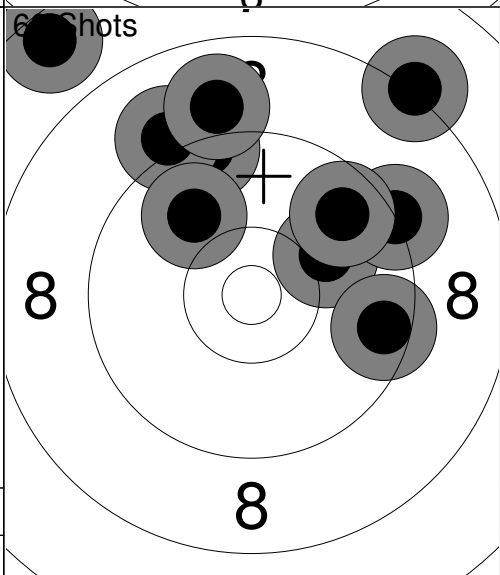

21:	8.2	↗
22:	10.1	↗
23:	9.3	↑
24:	9.2	↗
25:	7.5	↗
26:	9.1	↗
27:	8.9	↑
28:	9.5	→
29:	9.9	↗
30:	9.7	↗
Series	87 (0x)	
	245 (0x)	

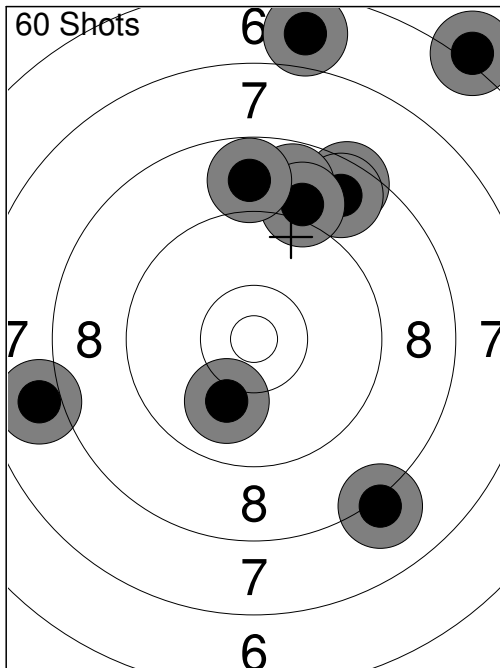

31:	8.5	↗
32:	8.1	↘
33:	8.7	↗
34:	6.8	↑
35:	6.1	↗
36:	7.9	←
37:	8.8	↑
38:	9.0	↑
39:	10.0	↘
40:	8.8	↑

Series 78 (0x)
323 (0x)

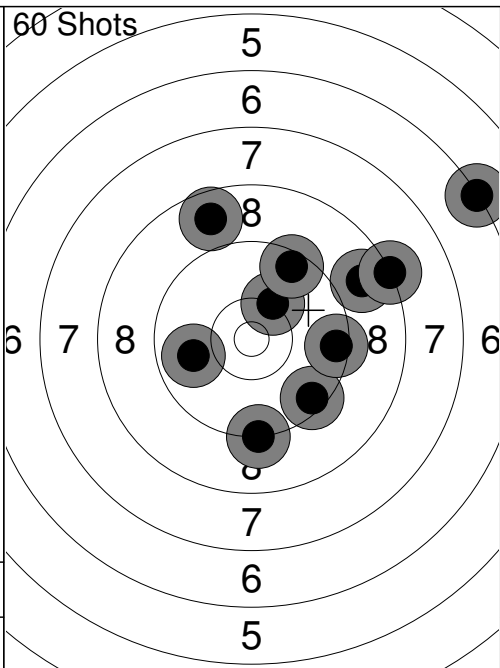

41:	10.2	↗
42:	9.5	↘
43:	9.5	↗
44:	6.2	↗
45:	8.7	↑
46:	9.2	↓
47:	9.5	→
48:	8.8	↗
49:	9.9	←
50:	8.2	↗

Series 85 (0x)
408 (0x)

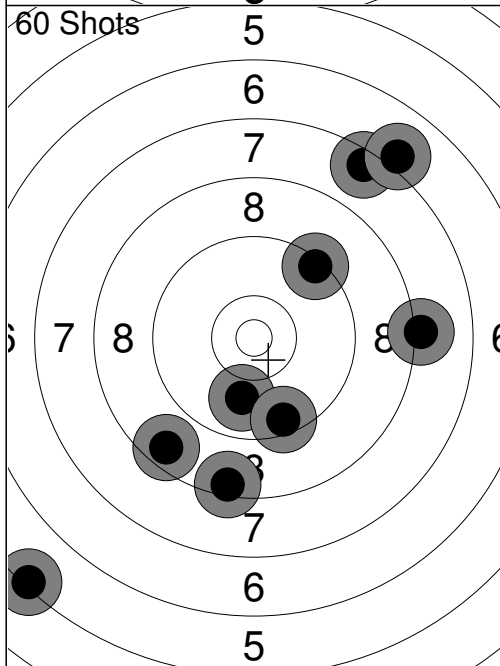

51:	8.4	↓
52:	9.9	↓
53:	9.5	↓
54:	9.3	↗
55:	7.5	↗
56:	8.1	→
57:	5.3	↙
58:	7.0	↗
59:	8.6	↙

Series 70 (0x)
478 (0x)

Relay 2	Lane 9	XU Helen
-------------------	------------------	-----------------

2023 SFC Pistol Nationals	BC	IJ	WP
---------------------------	----	----	----

15.07.2023	PN23AP-Q-1	Alberta Handgun Association
------------	------------	-----------------------------

Comment	Signature
---------	-----------

	1: 8.2 → 2: 8.2 → 3: 7.6 ↓ 4: 9.6 ↓ 5: 8.0 ↑ 6: 8.0 ↑ 7: 8.2 ↑ 8: 9.3 ↑ 9: 8.9 → 10: 8.9 ↑		11: 9.6 ↗ 12: 9.3 ↑ 13: 7.1 ↖
	Series 81 (0x) 0 (0x)		Series 25 (0x) 0 (0x)
	1: 8.8 ↗ 2: 10.4 → 3: 9.6 ↓ 4: 7.6 → 5: 10.0 → 6: 8.1 ↓ 7: 10.1 ↑ 8: 10.1 ↓ 9: 8.1 ↓ 10: 9.8 ←		11: 10.0 → 12: 9.7 ← 13: 7.8 ↑ 14: 9.0 ↑ 15: 7.6 ↖ 16: 9.7 ↗ 17: 9.4 ↓ 18: 8.5 ↑ 19: 7.2 ↑ 20: 9.3 ←
	Series 89 (0x) 89 (0x)		Series 84 (0x) 173 (0x)
	21: 9.8 ↑ 22: 7.9 ↑ 23: 10.6x ↓ 24: 10.1 ↑ 25: 9.6 → 26: 10.1 ↗ 27: 10.1 → 28: 10.1 ↑ 29: 10.1 ← 30: 9.5 ↑		31: 10.6x → 32: 10.8x ← 33: 10.6x ↖ 34: 8.7 ↗ 35: 8.3 ↓ 36: 8.7 ↑ 37: 9.6 ↑ 38: 9.8 ↑ 39: 8.8 → 40: 8.0 ↑
	Series 94 (1x) 267 (1x)		Series 88 (3x) 355 (4x)
	41: 9.3 ↗ 42: 7.4 ← 43: 7.6 ↑ 44: 9.5 ↑ 45: 10.5x ← 46: 9.8 → 47: 7.5 ↑ 48: 10.4x ← 49: 10.1 ↑ 50: 6.4 ↖		51: 9.4 ↖ 52: 9.2 ↗ 53: 7.8 ↓ 54: 8.0 ↑ 55: 10.8x ← 56: 8.9 ← 57: 10.0 ← 58: 8.8 → 59: 8.2 ↖ 60: 8.4 ↑
	Series 84 (2x) 439 (6x)		Series 85 (1x) 524 (7x)

Relay **2** Lane **10** **SONG Miya**

2023 SFC Pistol Nationals BC SS WP

15.07.2023 PN23AP-Q-1 Alberta Handgun Association

Comment Signature

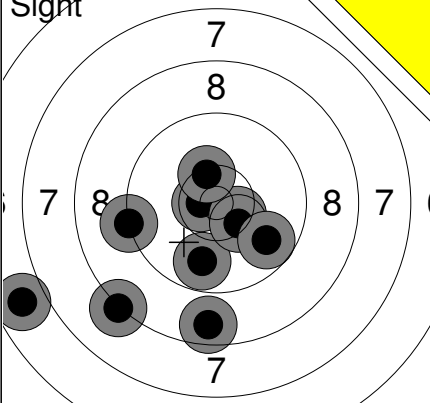
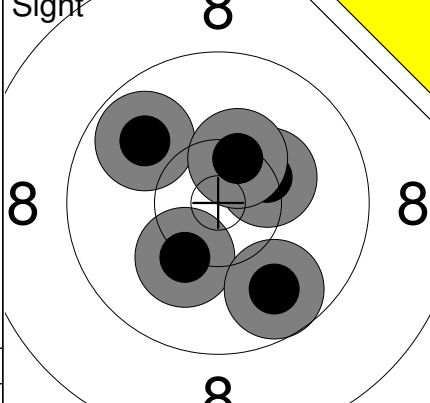
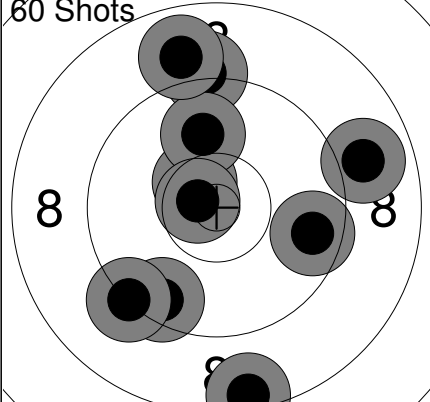
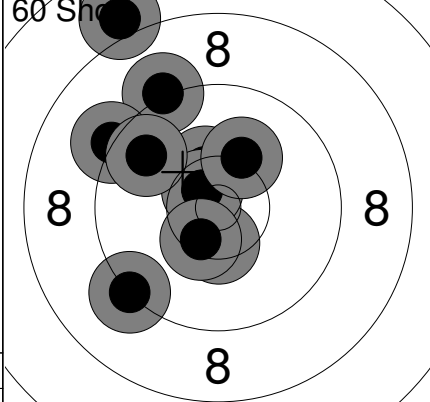
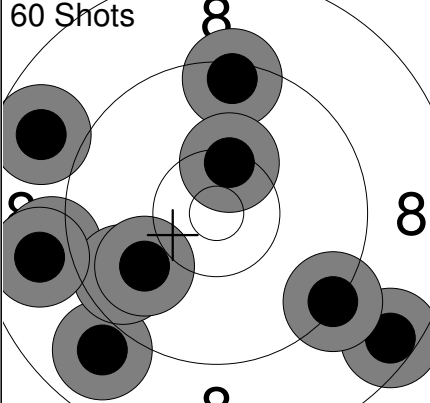
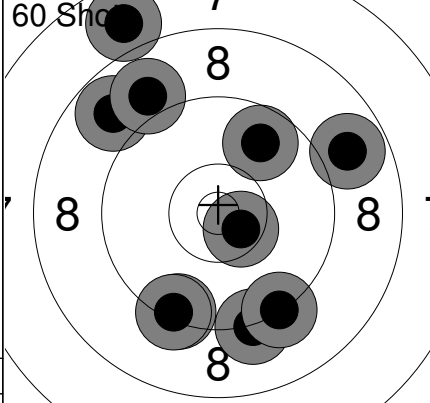
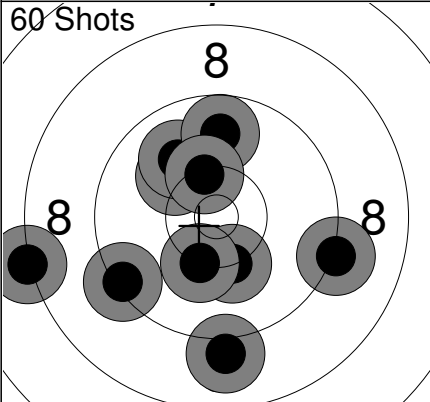
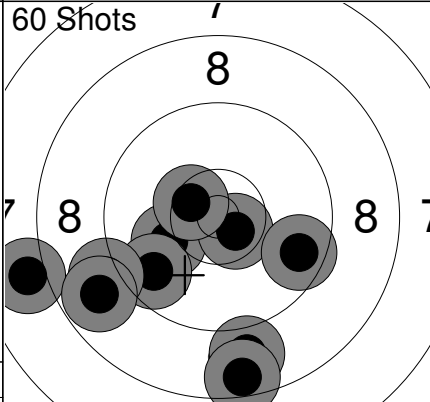
<p>Sight</p> 	<p>1: 6.8 ← 2: 10.6x ← 3: 8.6 ↓ 4: 9.8 ↓ 5: 10.5x ↓ 6: 8.2 ← 7: 9.2 ← 8: 10.4x ↓ 9: 10.4x ↑ 10: 9.8 ↓</p> <p>Series 89 (4x) 0 (0x)</p>	<p>Sight</p> 	<p>11: 9.9 ↖ 12: 10.3 → 13: 10.2 ↓ 14: 9.8 ↓ 15: 10.4x ↑</p> <p>Series 48 (1x) 0 (0x)</p>
<p>60 Shots</p> 	<p>1: 9.2 ↑ 2: 9.5 ↓ 3: 9.6 → 4: 8.9 → 5: 10.5x ↑ 6: 9.3 ← 7: 10.0 ↑ 8: 10.7x ← 9: 8.4 ↓ 10: 8.9 ↑</p> <p>Series 90 (2x) 90 (2x)</p>	<p>60 Shots</p> 	<p>11: 9.2 ↘ 12: 10.3 ↑ 13: 10.4x ↓ 14: 9.2 ↑ 15: 8.0 ↑ 16: 9.2 ↖ 17: 10.6x ↖ 18: 10.4x ↓ 19: 10.2 ↑ 20: 9.7 ↖</p> <p>Series 94 (3x) 184 (5x)</p>
<p>60 Shots</p> 	<p>21: 8.8 ← 22: 9.4 ↑ 23: 9.0 ← 24: 8.5 ↓ 25: 8.9 ↓ 26: 9.7 ← 27: 9.9 ← 28: 9.3 ↓ 29: 10.4x ↑ 30: 8.9 ←</p> <p>Series 87 (1x) 271 (6x)</p>	<p>60 Shots</p> 	<p>31: 8.8 ↖ 32: 10.5x ↓ 33: 9.2 ↓ 34: 8.8 → 35: 8.9 ↖ 36: 9.7 ↑ 37: 9.4 ↓ 38: 7.8 ↖ 39: 9.3 ↓ 40: 9.3 ↓</p> <p>Series 86 (1x) 357 (7x)</p>
<p>60 Shots</p> 	<p>41: 10.2 ↓ 42: 8.2 ← 43: 9.2 → 44: 9.3 ← 45: 10.1 ↖ 46: 10.0 ↖ 47: 9.8 ↑ 48: 10.3 ↑ 49: 9.0 ↓ 50: 10.3 ↓</p> <p>Series 94 (0x) 451 (7x)</p>	<p>60 Shots</p> 	<p>51: 10.1 ↖ 52: 9.7 ↖ 53: 10.6x ↓ 54: 9.0 ← 55: 8.8 ↓ 56: 8.0 ← 57: 8.5 ↓ 58: 8.8 ← 59: 9.6 → 60: 10.5x ↖</p> <p>Series 89 (2x) 540 (9x)</p>

Relay 2	Lane 11	BRITTON Kim
-------------------	-------------------	--------------------

2023 SFC Pistol Nationals	AB	EX	WP
---------------------------	----	----	----

15.07.2023	PN23AP-Q-1	Alberta Handgun Association
------------	------------	-----------------------------

Comment	Signature
---------	-----------

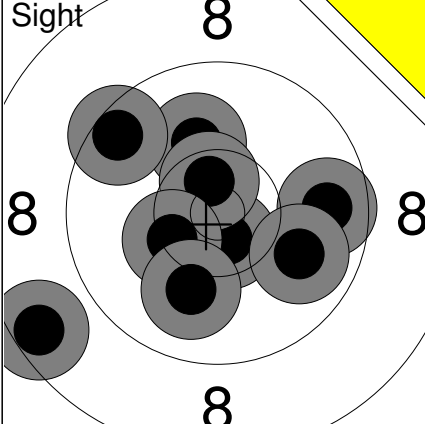
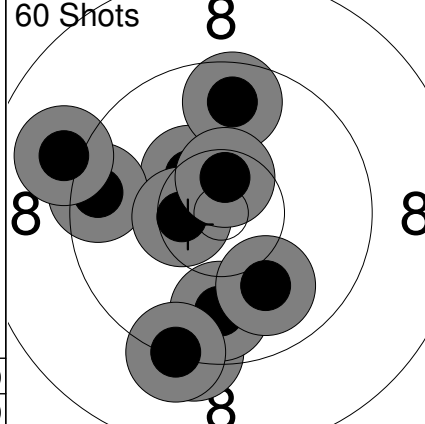
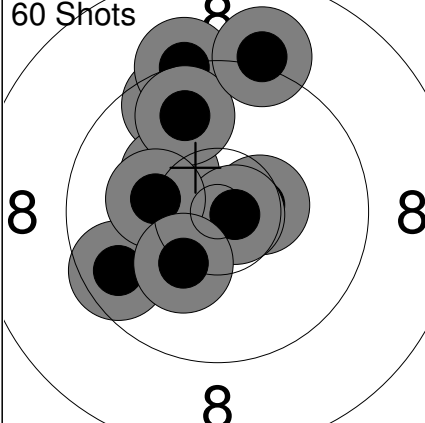
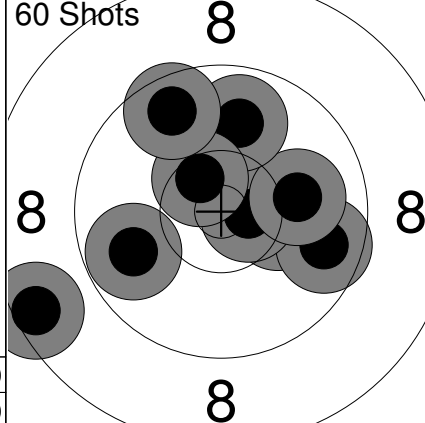
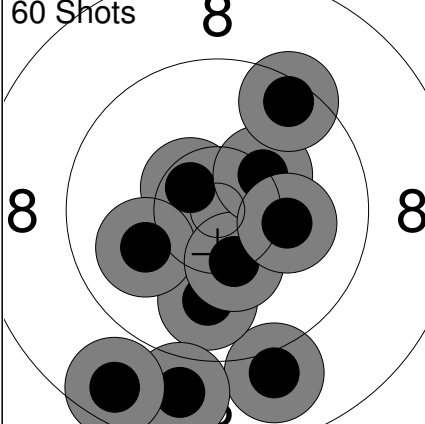
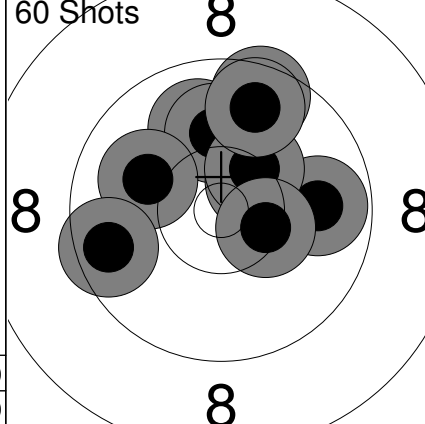
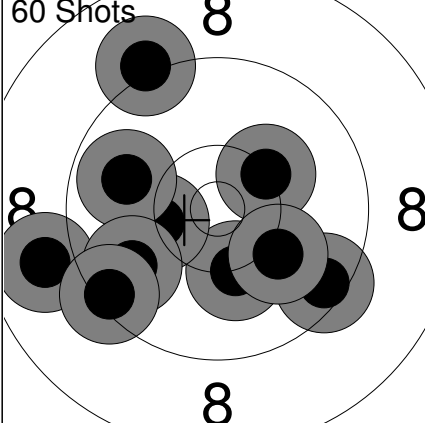
<p>Sight</p> 	<p>1: 10.1 ↗ 2: 9.5 ↗ 3: 9.7 → 4: 10.6x ↓ 5: 10.6x ↑ 6: 10.4 ← 7: 8.5 ← 8: 9.9 → 9: 10.0 ↓</p> <p>Series 85 (2x) 0 (0x)</p>	<p>60 Shots</p>  <p>1: 10.4x ↗ 2: 9.7 ↑ 3: 9.3 ↓ 4: 9.5 ← 5: 9.0 ← 6: 10.5x ← 7: 10.5x ↑ 8: 9.8 ↓ 9: 9.3 ↓ 10: 10.0 ↓</p> <p>Series 94 (3x) 94 (3x)</p>	
<p>60 Shots</p> 	<p>11: 10.5x → 12: 9.6 ↗ 13: 10.3 ↗ 14: 9.6 ← 15: 10.8x → 16: 9.3 ↑ 17: 9.8 ↑ 18: 10.2 ← 19: 10.2 ↓ 20: 9.1 ↑</p> <p>Series 95 (2x) 189 (5x)</p>	<p>60 Shots</p>  <p>21: 10.3 → 22: 10.3 → 23: 9.7 → 24: 8.5 ← 25: 10.6x → 26: 10.0 → 27: 9.9 ↑ 28: 10.5x ↗ 29: 9.8 ← 30: 9.6 ↗</p> <p>Series 94 (2x) 283 (7x)</p>	
<p>60 Shots</p> 	<p>31: 9.0 ↓ 32: 9.9 ↓ 33: 10.5x ↗ 34: 8.8 ↓ 35: 8.6 ↓ 36: 10.0 ← 37: 10.3 ↓ 38: 10.3 ↗ 39: 9.5 ↗ 40: 10.2 →</p> <p>Series 93 (1x) 376 (8x)</p>	<p>60 Shots</p>  <p>41: 10.0 ↑ 42: 10.1 ↑ 43: 10.0 ← 44: 9.6 ← 45: 9.6 ↑ 46: 10.4x ↗ 47: 9.8 → 48: 10.3 ↗ 49: 10.4x → 50: 9.7 ↑</p> <p>Series 96 (2x) 472 (10x)</p>	
<p>60 Shots</p> 	<p>51: 10.2 ↓ 52: 10.3 ↗ 53: 8.9 ← 54: 10.3 ← 55: 9.5 ↓ 56: 10.1 ↓ 57: 9.1 ↗ 58: 9.9 ← 59: 9.8 ← 60: 9.4 ↘</p> <p>Series 93 (0x) 565 (10x)</p>		

Relay 2	Lane 12	GUSTAFSON Liz
-------------------	-------------------	----------------------

2023 SFC Pistol Nationals	AB	EX	WP
---------------------------	----	----	----

15.07.2023	PN23AP-Q-1	Alberta Handgun Association
------------	------------	-----------------------------

Comment	Signature
---------	-----------

Sight 	1: 9.9 ← 2: 9.8 → 3: 9.3 ↓ 4: 10.3 ↓ 5: 9.5 ← 6: 10.2 ↗ 7: 10.1 ↗ 8: 9.5 → 9: 10.0 ↓ 10: 9.7 ←	Sight 	11: 9.6 ↗
	Series 94 (0x) 0 (0x)		Series 9 (0x) 0 (0x)
60 Shots 	1: 10.4x ↓ 2: 9.9 ↑ 3: 10.6x ← 4: 8.9 ↗ 5: 10.6x ↗ 6: 9.8 ↗ 7: 9.7 ↗ 8: 9.8 → 9: 10.7x ↓ 10: 10.0 ↑	60 Shots 	11: 9.5 ↓ 12: 9.3 ↑ 13: 9.6 ← 14: 10.8x ↓ 15: 9.1 ↑ 16: 8.5 ↑ 17: 10.2 ↗ 18: 10.3 ↓ 19: 8.9 ↗ 20: 9.4 ↗
	Series 94 (4x) 94 (4x)		Series 91 (1x) 185 (5x)
60 Shots 	21: 9.7 → 22: 9.7 ↗ 23: 9.2 ↗ 24: 10.3 ← 25: 9.1 ← 26: 10.7x ↓ 27: 10.4x ← 28: 9.5 → 29: 8.5 ↑ 30: 10.8x ←	60 Shots 	31: 10.4x ↘ 32: 10.3 ↓ 33: 9.9 ↗ 34: 8.7 ← 35: 9.4 ↓ 36: 9.1 ↓ 37: 7.4 → 38: 10.3 ← 39: 8.5 ↘ 40: 9.3 ↓
	Series 93 (3x) 278 (8x)		Series 89 (1x) 367 (9x)
60 Shots 	41: 9.9 ↗ 42: 10.3 ↗ 43: 10.2 ↓ 44: 10.6x ← 45: 10.7x ↗ 46: 10.1 ↓ 47: 8.9 → 48: 10.2 ← 49: 10.0 ↗ 50: 9.5 ↓	60 Shots 	51: 8.8 ↓ 52: 10.4x ← 53: 10.3 ↗ 54: 8.4 ← 55: 7.5 ↓ 56: 10.0 → 57: 8.8 ↓ 58: 6.9 ↓ 59: 9.4 ↓ 60: 9.2 ↓
	Series 96 (2x) 463 (11x)		Series 85 (1x) 548 (12x)

Comment	Signature
---------	-----------

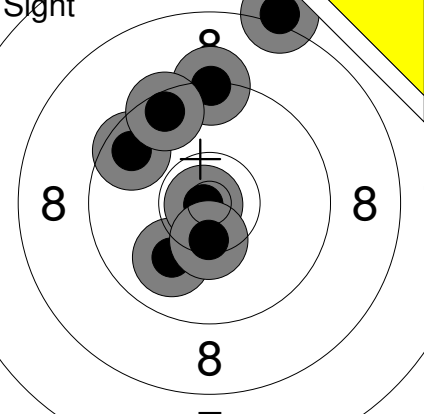
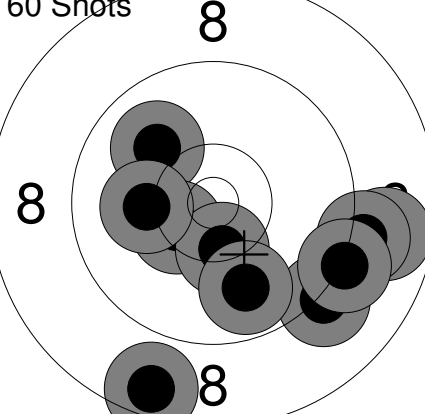
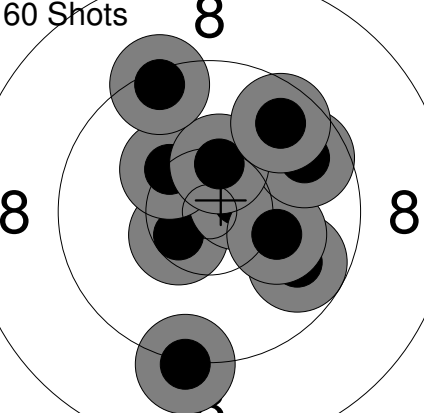
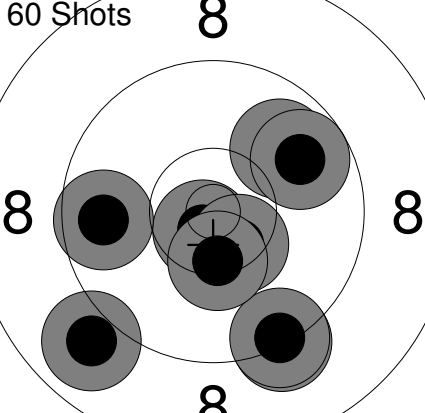
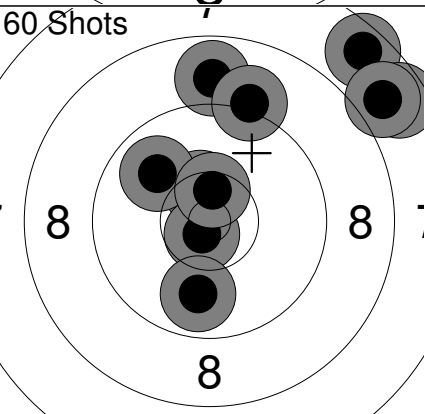
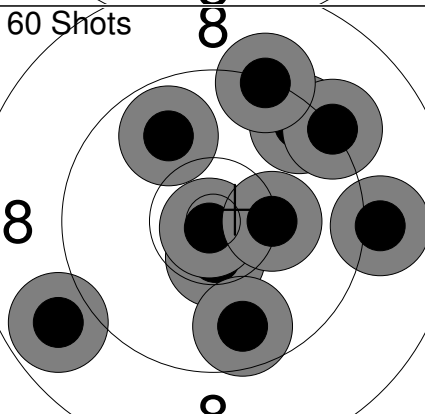
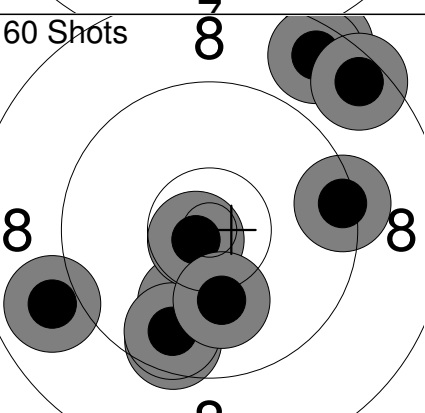
<p>Sight</p> 	<table border="1" style="width:100%; border-collapse: collapse;"> <tr><td>1:</td><td>8.1</td><td>↗</td></tr> <tr><td>2:</td><td>9.3</td><td>↗</td></tr> <tr><td>3:</td><td>9.6</td><td>↗</td></tr> <tr><td>4:</td><td>9.5</td><td>↗</td></tr> <tr><td>5:</td><td>10.0</td><td>↘</td></tr> <tr><td>6:</td><td>10.9x</td><td>↘</td></tr> <tr><td>7:</td><td>10.4x</td><td>↘</td></tr> <tr><td colspan="2">Series</td><td>65 (2x)</td></tr> <tr><td colspan="2"></td><td>0 (0x)</td></tr> </table>	1:	8.1	↗	2:	9.3	↗	3:	9.6	↗	4:	9.5	↗	5:	10.0	↘	6:	10.9x	↘	7:	10.4x	↘	Series		65 (2x)			0 (0x)	<p>60 Shots</p> 	<table border="1" style="width:100%; border-collapse: collapse;"> <tr><td>1:</td><td>10.0</td><td>↗</td></tr> <tr><td>2:</td><td>9.2</td><td>↘</td></tr> <tr><td>3:</td><td>10.4x</td><td>↖</td></tr> <tr><td>4:</td><td>8.8</td><td>→</td></tr> <tr><td>5:</td><td>9.1</td><td>→</td></tr> <tr><td>6:</td><td>8.6</td><td>↘</td></tr> <tr><td>7:</td><td>10.4x</td><td>↘</td></tr> <tr><td>8:</td><td>9.8</td><td>↘</td></tr> <tr><td>9:</td><td>10.1</td><td>←</td></tr> <tr><td>10:</td><td>9.2</td><td>↘</td></tr> <tr><td colspan="2">Series</td><td>92 (2x)</td></tr> <tr><td colspan="2"></td><td>92 (2x)</td></tr> </table>	1:	10.0	↗	2:	9.2	↘	3:	10.4x	↖	4:	8.8	→	5:	9.1	→	6:	8.6	↘	7:	10.4x	↘	8:	9.8	↘	9:	10.1	←	10:	9.2	↘	Series		92 (2x)			92 (2x)									
1:	8.1	↗																																																																									
2:	9.3	↗																																																																									
3:	9.6	↗																																																																									
4:	9.5	↗																																																																									
5:	10.0	↘																																																																									
6:	10.9x	↘																																																																									
7:	10.4x	↘																																																																									
Series		65 (2x)																																																																									
		0 (0x)																																																																									
1:	10.0	↗																																																																									
2:	9.2	↘																																																																									
3:	10.4x	↖																																																																									
4:	8.8	→																																																																									
5:	9.1	→																																																																									
6:	8.6	↘																																																																									
7:	10.4x	↘																																																																									
8:	9.8	↘																																																																									
9:	10.1	←																																																																									
10:	9.2	↘																																																																									
Series		92 (2x)																																																																									
		92 (2x)																																																																									
<p>60 Shots</p> 	<table border="1" style="width:100%; border-collapse: collapse;"> <tr><td>11:</td><td>10.5x</td><td>↖</td></tr> <tr><td>12:</td><td>10.6x</td><td>→</td></tr> <tr><td>13:</td><td>9.8</td><td>↘</td></tr> <tr><td>14:</td><td>10.1</td><td>→</td></tr> <tr><td>15:</td><td>9.7</td><td>→</td></tr> <tr><td>16:</td><td>10.3</td><td>↗</td></tr> <tr><td>17:</td><td>10.4x</td><td>↗</td></tr> <tr><td>18:</td><td>9.2</td><td>↘</td></tr> <tr><td>19:</td><td>9.7</td><td>↗</td></tr> <tr><td>20:</td><td>9.4</td><td>↗</td></tr> <tr><td colspan="2">Series</td><td>95 (3x)</td></tr> <tr><td colspan="2"></td><td>187 (5x)</td></tr> </table>	11:	10.5x	↖	12:	10.6x	→	13:	9.8	↘	14:	10.1	→	15:	9.7	→	16:	10.3	↗	17:	10.4x	↗	18:	9.2	↘	19:	9.7	↗	20:	9.4	↗	Series		95 (3x)			187 (5x)	<p>60 Shots</p> 	<table border="1" style="width:100%; border-collapse: collapse;"> <tr><td>21:</td><td>9.3</td><td>↘</td></tr> <tr><td>22:</td><td>9.9</td><td>↗</td></tr> <tr><td>23:</td><td>8.9</td><td>↖</td></tr> <tr><td>24:</td><td>10.6x</td><td>↘</td></tr> <tr><td>25:</td><td>9.8</td><td>↗</td></tr> <tr><td>26:</td><td>10.7x</td><td>↖</td></tr> <tr><td>27:</td><td>10.5x</td><td>↘</td></tr> <tr><td>28:</td><td>9.7</td><td>←</td></tr> <tr><td>29:</td><td>9.3</td><td>↘</td></tr> <tr><td>30:</td><td>10.4x</td><td>↘</td></tr> <tr><td colspan="2">Series</td><td>93 (4x)</td></tr> <tr><td colspan="2"></td><td>280 (9x)</td></tr> </table>	21:	9.3	↘	22:	9.9	↗	23:	8.9	↖	24:	10.6x	↘	25:	9.8	↗	26:	10.7x	↖	27:	10.5x	↘	28:	9.7	←	29:	9.3	↘	30:	10.4x	↘	Series		93 (4x)			280 (9x)
11:	10.5x	↖																																																																									
12:	10.6x	→																																																																									
13:	9.8	↘																																																																									
14:	10.1	→																																																																									
15:	9.7	→																																																																									
16:	10.3	↗																																																																									
17:	10.4x	↗																																																																									
18:	9.2	↘																																																																									
19:	9.7	↗																																																																									
20:	9.4	↗																																																																									
Series		95 (3x)																																																																									
		187 (5x)																																																																									
21:	9.3	↘																																																																									
22:	9.9	↗																																																																									
23:	8.9	↖																																																																									
24:	10.6x	↘																																																																									
25:	9.8	↗																																																																									
26:	10.7x	↖																																																																									
27:	10.5x	↘																																																																									
28:	9.7	←																																																																									
29:	9.3	↘																																																																									
30:	10.4x	↘																																																																									
Series		93 (4x)																																																																									
		280 (9x)																																																																									
<p>60 Shots</p> 	<table border="1" style="width:100%; border-collapse: collapse;"> <tr><td>31:</td><td>10.4x</td><td>↗</td></tr> <tr><td>32:</td><td>8.9</td><td>↗</td></tr> <tr><td>33:</td><td>7.6</td><td>↗</td></tr> <tr><td>34:</td><td>10.7x</td><td>↘</td></tr> <tr><td>35:</td><td>7.6</td><td>→</td></tr> <tr><td>36:</td><td>9.1</td><td>↗</td></tr> <tr><td>37:</td><td>9.9</td><td>↘</td></tr> <tr><td>38:</td><td>9.9</td><td>↗</td></tr> <tr><td>39:</td><td>10.5x</td><td>↗</td></tr> <tr><td>40:</td><td>7.8</td><td>↗</td></tr> <tr><td colspan="2">Series</td><td>86 (3x)</td></tr> <tr><td colspan="2"></td><td>366 (12x)</td></tr> </table>	31:	10.4x	↗	32:	8.9	↗	33:	7.6	↗	34:	10.7x	↘	35:	7.6	→	36:	9.1	↗	37:	9.9	↘	38:	9.9	↗	39:	10.5x	↗	40:	7.8	↗	Series		86 (3x)			366 (12x)	<p>60 Shots</p> 	<table border="1" style="width:100%; border-collapse: collapse;"> <tr><td>41:</td><td>10.5x</td><td>↘</td></tr> <tr><td>42:</td><td>10.9x</td><td>↖</td></tr> <tr><td>43:</td><td>9.7</td><td>↘</td></tr> <tr><td>44:</td><td>9.5</td><td>↗</td></tr> <tr><td>45:</td><td>8.8</td><td>↖</td></tr> <tr><td>46:</td><td>9.9</td><td>↗</td></tr> <tr><td>47:</td><td>9.1</td><td>→</td></tr> <tr><td>48:</td><td>9.2</td><td>↗</td></tr> <tr><td>49:</td><td>9.3</td><td>↗</td></tr> <tr><td>50:</td><td>10.3</td><td>→</td></tr> <tr><td colspan="2">Series</td><td>92 (2x)</td></tr> <tr><td colspan="2"></td><td>458 (14x)</td></tr> </table>	41:	10.5x	↘	42:	10.9x	↖	43:	9.7	↘	44:	9.5	↗	45:	8.8	↖	46:	9.9	↗	47:	9.1	→	48:	9.2	↗	49:	9.3	↗	50:	10.3	→	Series		92 (2x)			458 (14x)
31:	10.4x	↗																																																																									
32:	8.9	↗																																																																									
33:	7.6	↗																																																																									
34:	10.7x	↘																																																																									
35:	7.6	→																																																																									
36:	9.1	↗																																																																									
37:	9.9	↘																																																																									
38:	9.9	↗																																																																									
39:	10.5x	↗																																																																									
40:	7.8	↗																																																																									
Series		86 (3x)																																																																									
		366 (12x)																																																																									
41:	10.5x	↘																																																																									
42:	10.9x	↖																																																																									
43:	9.7	↘																																																																									
44:	9.5	↗																																																																									
45:	8.8	↖																																																																									
46:	9.9	↗																																																																									
47:	9.1	→																																																																									
48:	9.2	↗																																																																									
49:	9.3	↗																																																																									
50:	10.3	→																																																																									
Series		92 (2x)																																																																									
		458 (14x)																																																																									
<p>60 Shots</p> 	<table border="1" style="width:100%; border-collapse: collapse;"> <tr><td>51:</td><td>9.6</td><td>↘</td></tr> <tr><td>52:</td><td>9.4</td><td>→</td></tr> <tr><td>53:</td><td>10.1</td><td>↘</td></tr> <tr><td>54:</td><td>9.7</td><td>↘</td></tr> <tr><td>55:</td><td>8.4</td><td>↗</td></tr> <tr><td>56:</td><td>8.6</td><td>↗</td></tr> <tr><td>57:</td><td>8.5</td><td>↗</td></tr> <tr><td>58:</td><td>10.8x</td><td>↖</td></tr> <tr><td>59:</td><td>10.1</td><td>↘</td></tr> <tr><td>60:</td><td>8.9</td><td>↖</td></tr> <tr><td colspan="2">Series</td><td>89 (1x)</td></tr> <tr><td colspan="2"></td><td>547 (15x)</td></tr> </table>	51:	9.6	↘	52:	9.4	→	53:	10.1	↘	54:	9.7	↘	55:	8.4	↗	56:	8.6	↗	57:	8.5	↗	58:	10.8x	↖	59:	10.1	↘	60:	8.9	↖	Series		89 (1x)			547 (15x)																																						
51:	9.6	↘																																																																									
52:	9.4	→																																																																									
53:	10.1	↘																																																																									
54:	9.7	↘																																																																									
55:	8.4	↗																																																																									
56:	8.6	↗																																																																									
57:	8.5	↗																																																																									
58:	10.8x	↖																																																																									
59:	10.1	↘																																																																									
60:	8.9	↖																																																																									
Series		89 (1x)																																																																									
		547 (15x)																																																																									

Relay **2** Lane **14** **KRANENBURG Lori**

2023 SFC Pistol Nationals ON EX WP

15.07.2023 PN23AP-Q-1 Alberta Handgun Association

Comment Signature

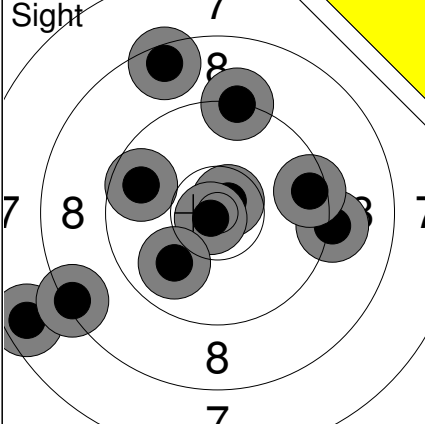
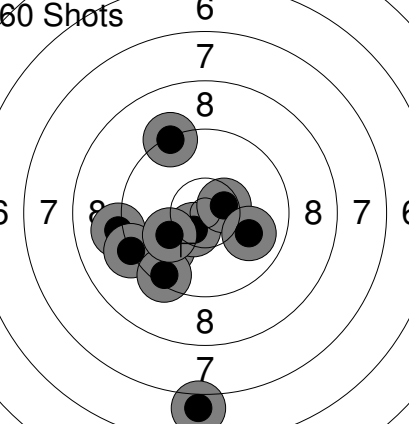
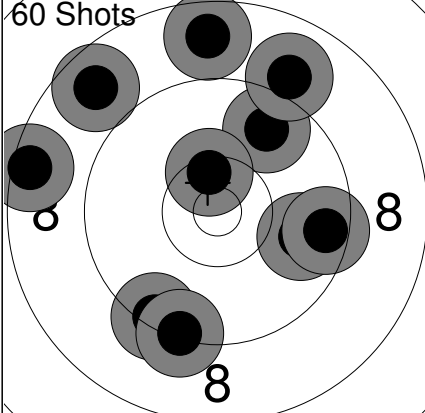
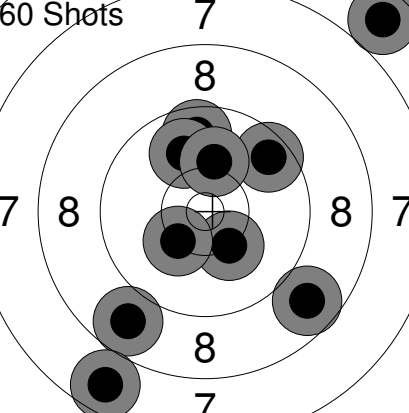
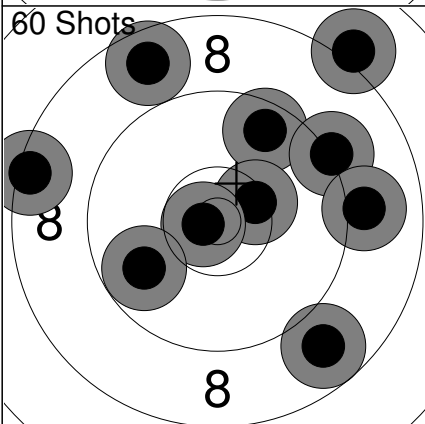
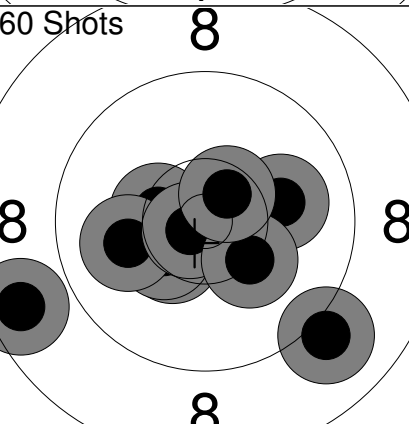
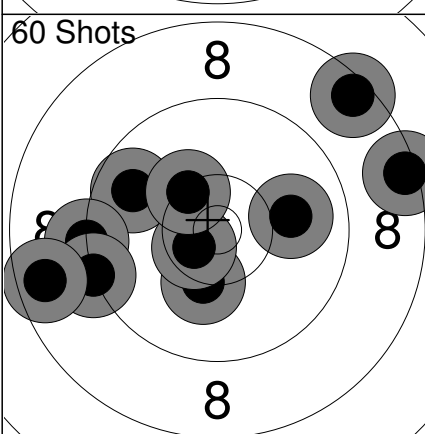
<p>Sight</p> 	<p>1: 10.7x ↗ 2: 9.7 ← 3: 9.2 → 4: 9.5 → 5: 7.6 ← 6: 8.5 ↗ 7: 10.8x ↙ 8: 8.3 ← 9: 9.9 ↙ 10: 9.3 ↑</p> <p>Series 88 (2x) 0 (0x)</p>	<p>60 Shots</p> 	<p>1: 9.1 ← 2: 6.9 ↓ 3: 9.9 ↙ 4: 9.2 ← 5: 10.5x ↙ 6: 9.4 ↙ 7: 10.1 ← 8: 10.5x → 9: 9.3 ↗ 10: 10.0 →</p> <p>Series 91 (2x) 91 (2x)</p>
<p>60 Shots</p> 	<p>11: 9.4 ↙ 12: 8.5 ← 13: 9.8 → 14: 8.7 ↑ 15: 9.7 ↗ 16: 9.5 → 17: 9.3 ↙ 18: 9.0 ↗ 19: 10.4x ↗ 20: 8.7 ↘</p> <p>Series 88 (1x) 179 (3x)</p>	<p>60 Shots</p> 	<p>21: 9.7 ↑ 22: 8.8 ↙ 23: 9.9 ↗ 24: 9.6 ↗ 25: 7.7 ↙ 26: 10.3 ↙ 27: 10.3 ↙ 28: 8.7 ↘ 29: 10.1 ↑ 30: 6.7 ↗</p> <p>Series 86 (0x) 265 (3x)</p>
<p>60 Shots</p> 	<p>31: 9.6 ↗ 32: 9.2 → 33: 8.4 ← 34: 10.4x → 35: 9.0 → 36: 8.7 ↗ 37: 10.8x ← 38: 8.8 ↙ 39: 8.1 ↗ 40: 9.8 ←</p> <p>Series 88 (2x) 353 (5x)</p>	<p>60 Shots</p> 	<p>41: 10.4x ↙ 42: 10.1 → 43: 10.4x ← 44: 10.4x ← 45: 10.0 ← 46: 10.8x ← 47: 8.6 ← 48: 10.3 ↘ 49: 9.0 ↘ 50: 10.5x ↗</p> <p>Series 97 (5x) 450 (10x)</p>
<p>60 Shots</p> 	<p>51: 9.7 ← 52: 10.2 ↓ 53: 10.6x ↙ 54: 8.4 → 55: 9.2 ← 56: 10.0 → 57: 10.3 ↗ 58: 9.2 ← 59: 8.5 ↗ 60: 8.6 ←</p> <p>Series 91 (1x) 541 (11x)</p>		

Relay **2** Lane **15** **LE SIEUR Audrey anne**

2023 SFC Pistol Nationals QC EX WP

15.07.2023 PN23AP-Q-1 Alberta Handgun Association

Comment Signature

	1: 10.0 ↘ 2: 10.6x → 3: 9.4 → 4: 10.1 ↘ 5: 8.5 ↗ 6: 9.9 ↘ 7: 8.2 ↘ 8: 9.8 → 9: 9.3 ↘ 10: 10.0 ←		1: 10.5x ↑ 2: 10.0 ↘ 3: 9.8 → 4: 9.7 ↘ 5: 8.4 → 6: 9.5 → 7: 9.7 ↘ 8: 10.7x ← 9: 10.0 ↘ 10: 9.9 ↘
	Series 92 (1x) 0 (0x)		Series 93 (2x) 93 (2x)

	11: 9.4 ↘ 12: 10.6x ↗ 13: 10.8x ↘ 14: 9.8 ↘ 15: 10.3 ↗ 16: 9.1 → 17: 9.8 ↑ 18: 9.1 ↘ 19: 10.7x ↗ 20: 9.0 →		21: 10.1 → 22: 10.6x ↗ 23: 10.4x ↑ 24: 10.1 ↘ 25: 10.6x ↑ 26: 8.5 ↗ 27: 8.5 ↘ 28: 9.5 ↑ 29: 7.8 → 30: 10.4x ↗
	Series 94 (3x) 187 (5x)		Series 92 (4x) 279 (9x)

	31: 10.1 ↘ 32: 9.8 → 33: 7.7 → 34: 9.5 → 35: 7.7 → 36: 8.6 → 37: 10.0 ↘ 38: 7.1 → 39: 9.7 ↗ 40: 9.7 ↗		41: 8.2 → 42: 9.5 → 43: 9.9 → 44: 10.2 → 45: 10.3 ← 46: 9.0 → 47: 10.0 → 48: 9.2 → 49: 8.0 → 50: 9.8 →
	Series 85 (0x) 364 (9x)		Series 91 (0x) 455 (9x)

	51: 9.4 → 52: 9.8 ↘ 53: 10.5x ↗ 54: 8.0 → 55: 10.1 ↘ 56: 6.9 ↘ 57: 7.5 → 58: 7.6 → 59: 10.1 ↘ 60: 10.2 ↘		51: 9.4 → 52: 9.8 ↘ 53: 10.5x ↗ 54: 8.0 → 55: 10.1 ↘ 56: 6.9 ↘ 57: 7.5 → 58: 7.6 → 59: 10.1 ↘ 60: 10.2 ↘
	Series 86 (1x) 541 (10x)		Series 91 (0x) 455 (9x)

Comment	Signature
---------	-----------

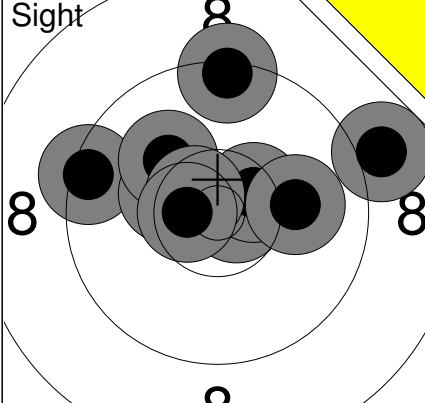
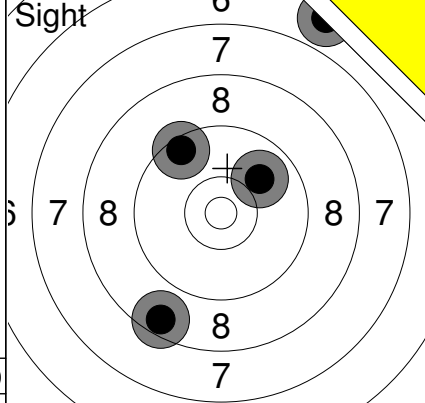
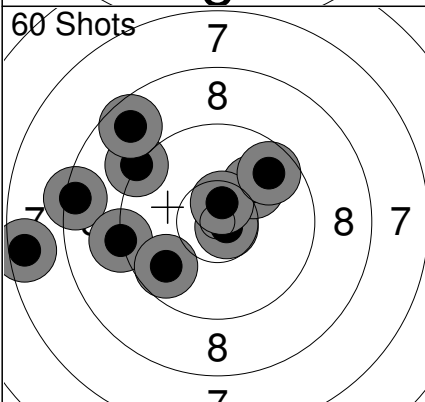
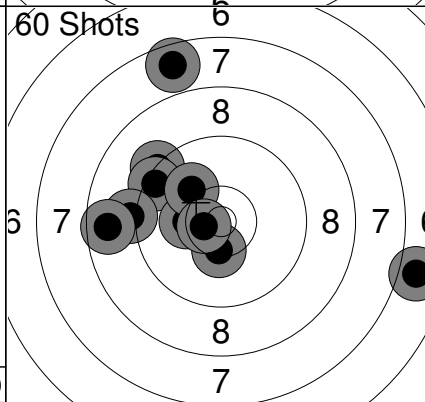
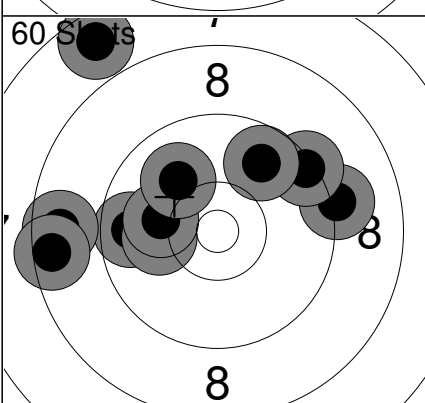
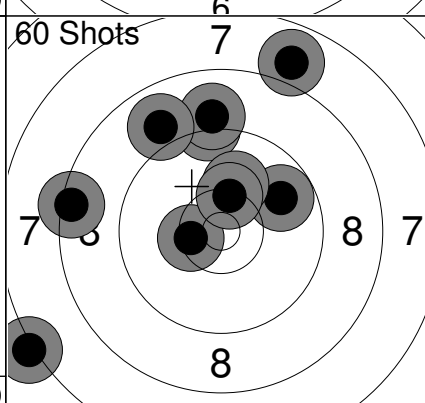
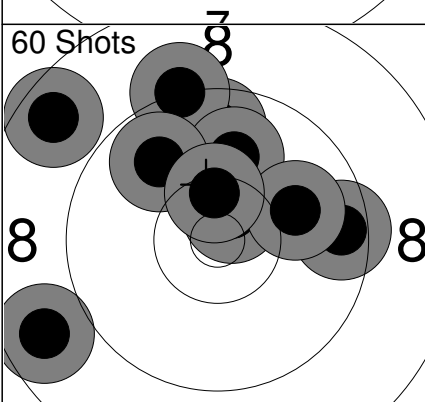
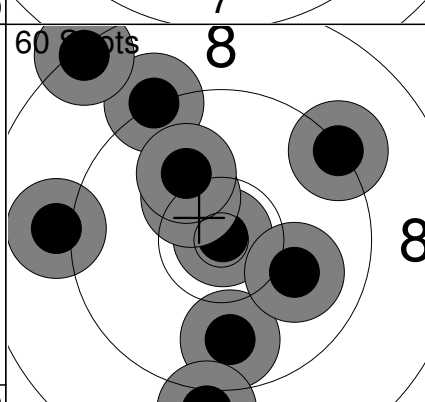
<p>Sight</p> 	<table border="1" style="width:100%; border-collapse: collapse;"> <tr><td>1:</td><td>9.0</td><td>→</td></tr> <tr><td>2:</td><td>10.7x</td><td>→</td></tr> <tr><td>3:</td><td>10.5x</td><td>→</td></tr> <tr><td>4:</td><td>9.4</td><td>←</td></tr> <tr><td>5:</td><td>10.3</td><td>←</td></tr> <tr><td>6:</td><td>10.1</td><td>↗</td></tr> <tr><td>7:</td><td>9.4</td><td>↑</td></tr> <tr><td>8:</td><td>10.1</td><td>→</td></tr> <tr><td>9:</td><td>10.6x</td><td>↗</td></tr> <tr><td>10:</td><td>10.6x</td><td>←</td></tr> <tr><td colspan="2">Series</td><td>97 (4x)</td></tr> <tr><td colspan="2"></td><td>0 (0x)</td></tr> </table>	1:	9.0	→	2:	10.7x	→	3:	10.5x	→	4:	9.4	←	5:	10.3	←	6:	10.1	↗	7:	9.4	↑	8:	10.1	→	9:	10.6x	↗	10:	10.6x	←	Series		97 (4x)			0 (0x)	<p>Sight</p> 	<table border="1" style="width:100%; border-collapse: collapse;"> <tr><td>11:</td><td>6.6</td><td>↗</td></tr> <tr><td>12:</td><td>9.9</td><td>↗</td></tr> <tr><td>13:</td><td>8.5</td><td>↘</td></tr> <tr><td>14:</td><td>9.5</td><td>↗</td></tr> <tr><td colspan="2">Series</td><td>32 (0x)</td></tr> <tr><td colspan="2"></td><td>0 (0x)</td></tr> </table>	11:	6.6	↗	12:	9.9	↗	13:	8.5	↘	14:	9.5	↗	Series		32 (0x)			0 (0x)																		
1:	9.0	→																																																																									
2:	10.7x	→																																																																									
3:	10.5x	→																																																																									
4:	9.4	←																																																																									
5:	10.3	←																																																																									
6:	10.1	↗																																																																									
7:	9.4	↑																																																																									
8:	10.1	→																																																																									
9:	10.6x	↗																																																																									
10:	10.6x	←																																																																									
Series		97 (4x)																																																																									
		0 (0x)																																																																									
11:	6.6	↗																																																																									
12:	9.9	↗																																																																									
13:	8.5	↘																																																																									
14:	9.5	↗																																																																									
Series		32 (0x)																																																																									
		0 (0x)																																																																									
<p>60 Shots</p> 	<table border="1" style="width:100%; border-collapse: collapse;"> <tr><td>1:</td><td>9.2</td><td>↖</td></tr> <tr><td>2:</td><td>8.7</td><td>↗</td></tr> <tr><td>3:</td><td>8.4</td><td>←</td></tr> <tr><td>4:</td><td>10.8x</td><td>↘</td></tr> <tr><td>5:</td><td>10.1</td><td>↗</td></tr> <tr><td>6:</td><td>7.5</td><td>←</td></tr> <tr><td>7:</td><td>10.6x</td><td>↑</td></tr> <tr><td>8:</td><td>9.7</td><td>↗</td></tr> <tr><td>9:</td><td>9.2</td><td>←</td></tr> <tr><td>10:</td><td>9.8</td><td>↘</td></tr> <tr><td colspan="2">Series</td><td>89 (2x)</td></tr> <tr><td colspan="2"></td><td>89 (2x)</td></tr> </table>	1:	9.2	↖	2:	8.7	↗	3:	8.4	←	4:	10.8x	↘	5:	10.1	↗	6:	7.5	←	7:	10.6x	↑	8:	9.7	↗	9:	9.2	←	10:	9.8	↘	Series		89 (2x)			89 (2x)	<p>60 Shots</p> 	<table border="1" style="width:100%; border-collapse: collapse;"> <tr><td>11:</td><td>9.3</td><td>↖</td></tr> <tr><td>12:</td><td>9.4</td><td>↖</td></tr> <tr><td>13:</td><td>6.9</td><td>→</td></tr> <tr><td>14:</td><td>9.1</td><td>←</td></tr> <tr><td>15:</td><td>8.7</td><td>←</td></tr> <tr><td>16:</td><td>7.6</td><td>↑</td></tr> <tr><td>17:</td><td>10.3</td><td>←</td></tr> <tr><td>18:</td><td>10.4x</td><td>↓</td></tr> <tr><td>19:</td><td>10.1</td><td>↗</td></tr> <tr><td>20:</td><td>10.6x</td><td>←</td></tr> <tr><td colspan="2">Series</td><td>88 (2x)</td></tr> <tr><td colspan="2"></td><td>177 (4x)</td></tr> </table>	11:	9.3	↖	12:	9.4	↖	13:	6.9	→	14:	9.1	←	15:	8.7	←	16:	7.6	↑	17:	10.3	←	18:	10.4x	↓	19:	10.1	↗	20:	10.6x	←	Series		88 (2x)			177 (4x)
1:	9.2	↖																																																																									
2:	8.7	↗																																																																									
3:	8.4	←																																																																									
4:	10.8x	↘																																																																									
5:	10.1	↗																																																																									
6:	7.5	←																																																																									
7:	10.6x	↑																																																																									
8:	9.7	↗																																																																									
9:	9.2	←																																																																									
10:	9.8	↘																																																																									
Series		89 (2x)																																																																									
		89 (2x)																																																																									
11:	9.3	↖																																																																									
12:	9.4	↖																																																																									
13:	6.9	→																																																																									
14:	9.1	←																																																																									
15:	8.7	←																																																																									
16:	7.6	↑																																																																									
17:	10.3	←																																																																									
18:	10.4x	↓																																																																									
19:	10.1	↗																																																																									
20:	10.6x	←																																																																									
Series		88 (2x)																																																																									
		177 (4x)																																																																									
<p>60 Shots</p> 	<table border="1" style="width:100%; border-collapse: collapse;"> <tr><td>21:</td><td>9.7</td><td>←</td></tr> <tr><td>22:</td><td>10.1</td><td>←</td></tr> <tr><td>23:</td><td>8.6</td><td>←</td></tr> <tr><td>24:</td><td>10.1</td><td>←</td></tr> <tr><td>25:</td><td>9.2</td><td>→</td></tr> <tr><td>26:</td><td>7.7</td><td>↗</td></tr> <tr><td>27:</td><td>10.0</td><td>↗</td></tr> <tr><td>28:</td><td>9.4</td><td>↗</td></tr> <tr><td>29:</td><td>8.5</td><td>←</td></tr> <tr><td>30:</td><td>9.8</td><td>↗</td></tr> <tr><td colspan="2">Series</td><td>89 (0x)</td></tr> <tr><td colspan="2"></td><td>266 (4x)</td></tr> </table>	21:	9.7	←	22:	10.1	←	23:	8.6	←	24:	10.1	←	25:	9.2	→	26:	7.7	↗	27:	10.0	↗	28:	9.4	↗	29:	8.5	←	30:	9.8	↗	Series		89 (0x)			266 (4x)	<p>60 Shots</p> 	<table border="1" style="width:100%; border-collapse: collapse;"> <tr><td>31:</td><td>9.2</td><td>↑</td></tr> <tr><td>32:</td><td>9.8</td><td>↗</td></tr> <tr><td>33:</td><td>10.4x</td><td>←</td></tr> <tr><td>34:</td><td>7.9</td><td>↑</td></tr> <tr><td>35:</td><td>9.0</td><td>↑</td></tr> <tr><td>36:</td><td>10.1</td><td>↑</td></tr> <tr><td>37:</td><td>7.1</td><td>←</td></tr> <tr><td>38:</td><td>8.9</td><td>↗</td></tr> <tr><td>39:</td><td>10.3</td><td>↑</td></tr> <tr><td>40:</td><td>8.4</td><td>←</td></tr> <tr><td colspan="2">Series</td><td>87 (1x)</td></tr> <tr><td colspan="2"></td><td>353 (5x)</td></tr> </table>	31:	9.2	↑	32:	9.8	↗	33:	10.4x	←	34:	7.9	↑	35:	9.0	↑	36:	10.1	↑	37:	7.1	←	38:	8.9	↗	39:	10.3	↑	40:	8.4	←	Series		87 (1x)			353 (5x)
21:	9.7	←																																																																									
22:	10.1	←																																																																									
23:	8.6	←																																																																									
24:	10.1	←																																																																									
25:	9.2	→																																																																									
26:	7.7	↗																																																																									
27:	10.0	↗																																																																									
28:	9.4	↗																																																																									
29:	8.5	←																																																																									
30:	9.8	↗																																																																									
Series		89 (0x)																																																																									
		266 (4x)																																																																									
31:	9.2	↑																																																																									
32:	9.8	↗																																																																									
33:	10.4x	←																																																																									
34:	7.9	↑																																																																									
35:	9.0	↑																																																																									
36:	10.1	↑																																																																									
37:	7.1	←																																																																									
38:	8.9	↗																																																																									
39:	10.3	↑																																																																									
40:	8.4	←																																																																									
Series		87 (1x)																																																																									
		353 (5x)																																																																									
<p>60 Shots</p> 	<table border="1" style="width:100%; border-collapse: collapse;"> <tr><td>41:</td><td>8.7</td><td>←</td></tr> <tr><td>42:</td><td>10.6x</td><td>↗</td></tr> <tr><td>43:</td><td>9.7</td><td>↑</td></tr> <tr><td>44:</td><td>8.6</td><td>↗</td></tr> <tr><td>45:</td><td>9.2</td><td>↗</td></tr> <tr><td>46:</td><td>10.0</td><td>↑</td></tr> <tr><td>47:</td><td>9.5</td><td>→</td></tr> <tr><td>48:</td><td>9.8</td><td>↗</td></tr> <tr><td>49:</td><td>10.0</td><td>→</td></tr> <tr><td>50:</td><td>10.4x</td><td>↑</td></tr> <tr><td colspan="2">Series</td><td>92 (2x)</td></tr> <tr><td colspan="2"></td><td>445 (7x)</td></tr> </table>	41:	8.7	←	42:	10.6x	↗	43:	9.7	↑	44:	8.6	↗	45:	9.2	↗	46:	10.0	↑	47:	9.5	→	48:	9.8	↗	49:	10.0	→	50:	10.4x	↑	Series		92 (2x)			445 (7x)	<p>60 Shots</p> 	<table border="1" style="width:100%; border-collapse: collapse;"> <tr><td>51:</td><td>10.9x</td><td>↗</td></tr> <tr><td>52:</td><td>9.8</td><td>↓</td></tr> <tr><td>53:</td><td>9.0</td><td>↓</td></tr> <tr><td>54:</td><td>10.4x</td><td>↗</td></tr> <tr><td>55:</td><td>9.2</td><td>↗</td></tr> <tr><td>56:</td><td>8.3</td><td>↗</td></tr> <tr><td>57:</td><td>9.3</td><td>↗</td></tr> <tr><td>58:</td><td>10.0</td><td>→</td></tr> <tr><td>59:</td><td>9.1</td><td>←</td></tr> <tr><td>60:</td><td>10.1</td><td>↗</td></tr> <tr><td colspan="2">Series</td><td>93 (2x)</td></tr> <tr><td colspan="2"></td><td>538 (9x)</td></tr> </table>	51:	10.9x	↗	52:	9.8	↓	53:	9.0	↓	54:	10.4x	↗	55:	9.2	↗	56:	8.3	↗	57:	9.3	↗	58:	10.0	→	59:	9.1	←	60:	10.1	↗	Series		93 (2x)			538 (9x)
41:	8.7	←																																																																									
42:	10.6x	↗																																																																									
43:	9.7	↑																																																																									
44:	8.6	↗																																																																									
45:	9.2	↗																																																																									
46:	10.0	↑																																																																									
47:	9.5	→																																																																									
48:	9.8	↗																																																																									
49:	10.0	→																																																																									
50:	10.4x	↑																																																																									
Series		92 (2x)																																																																									
		445 (7x)																																																																									
51:	10.9x	↗																																																																									
52:	9.8	↓																																																																									
53:	9.0	↓																																																																									
54:	10.4x	↗																																																																									
55:	9.2	↗																																																																									
56:	8.3	↗																																																																									
57:	9.3	↗																																																																									
58:	10.0	→																																																																									
59:	9.1	←																																																																									
60:	10.1	↗																																																																									
Series		93 (2x)																																																																									
		538 (9x)																																																																									

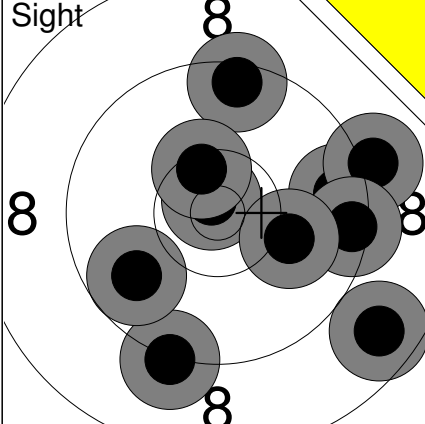
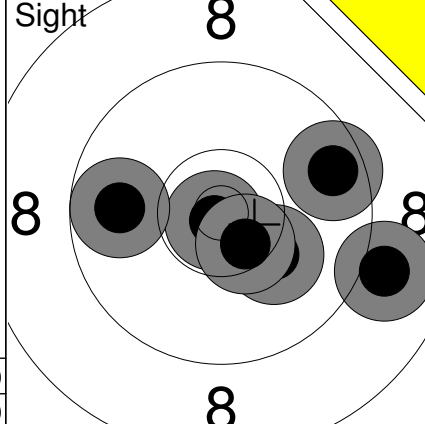
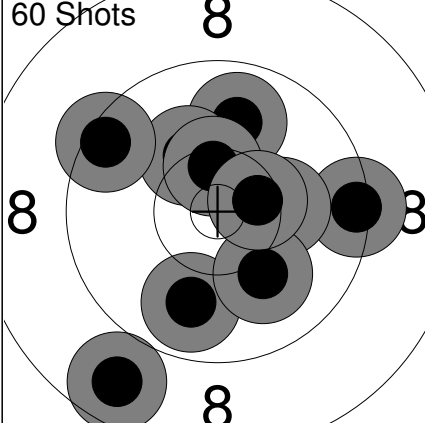
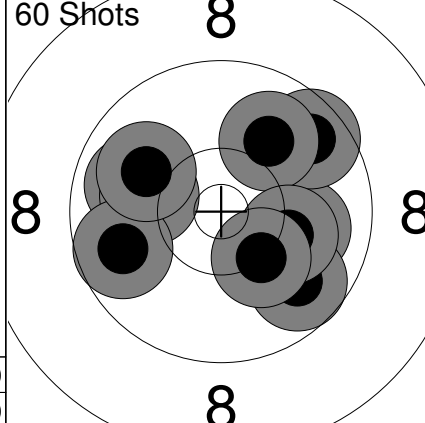
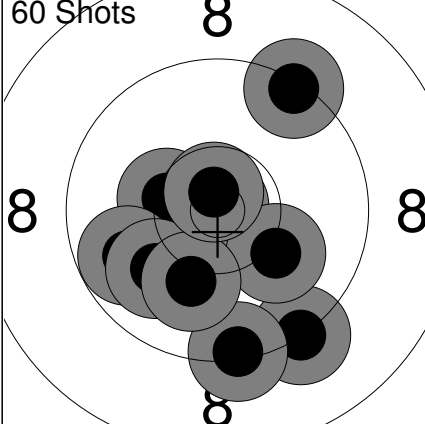
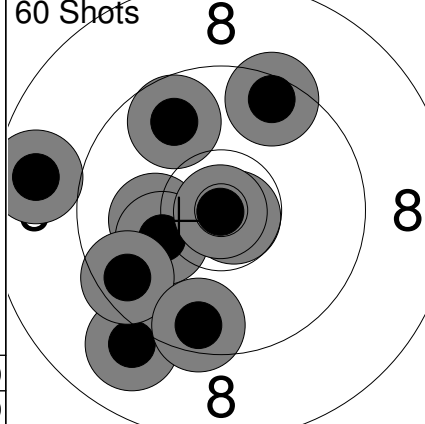
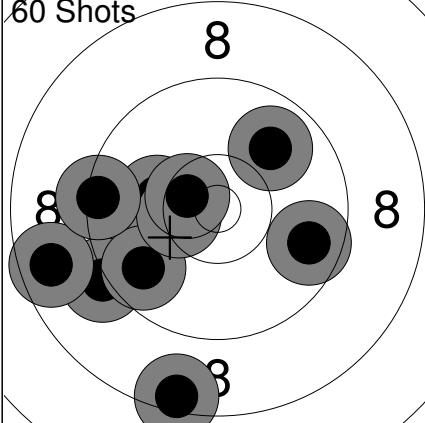
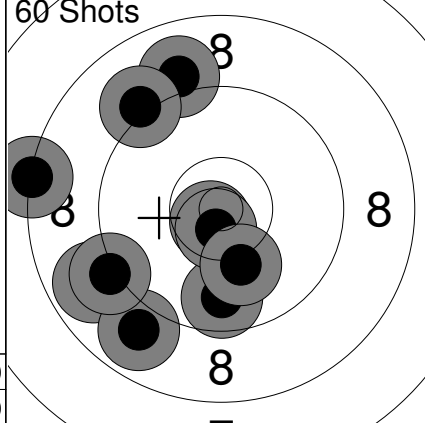
<p>Sight</p> 	<table border="1" style="width:100%; border-collapse: collapse;"> <tr><td>1:</td><td>9.4</td><td>↑</td></tr> <tr><td>2:</td><td>10.8x</td><td>↑</td></tr> <tr><td>3:</td><td>9.6</td><td>→</td></tr> <tr><td>4:</td><td>9.1</td><td>→</td></tr> <tr><td>5:</td><td>9.2</td><td>↓</td></tr> <tr><td>6:</td><td>8.7</td><td>↓</td></tr> <tr><td>7:</td><td>9.8</td><td>←</td></tr> <tr><td>8:</td><td>9.4</td><td>→</td></tr> <tr><td>9:</td><td>10.4x</td><td>↑</td></tr> <tr><td>10:</td><td>10.1</td><td>→</td></tr> <tr><td colspan="2">Series</td><td>92 (2x)</td></tr> <tr><td colspan="2"></td><td>0 (0x)</td></tr> </table>	1:	9.4	↑	2:	10.8x	↑	3:	9.6	→	4:	9.1	→	5:	9.2	↓	6:	8.7	↓	7:	9.8	←	8:	9.4	→	9:	10.4x	↑	10:	10.1	→	Series		92 (2x)			0 (0x)	<p>Sight</p> 	<table border="1" style="width:100%; border-collapse: collapse;"> <tr><td>11:</td><td>10.8x</td><td>↙</td></tr> <tr><td>12:</td><td>10.2</td><td>↘</td></tr> <tr><td>13:</td><td>9.6</td><td>→</td></tr> <tr><td>14:</td><td>10.5x</td><td>↘</td></tr> <tr><td>15:</td><td>9.0</td><td>→</td></tr> <tr><td>16:</td><td>9.8</td><td>←</td></tr> <tr><td colspan="2">Series</td><td>57 (2x)</td></tr> <tr><td colspan="2"></td><td>0 (0x)</td></tr> </table>	11:	10.8x	↙	12:	10.2	↘	13:	9.6	→	14:	10.5x	↘	15:	9.0	→	16:	9.8	←	Series		57 (2x)			0 (0x)												
1:	9.4	↑																																																																									
2:	10.8x	↑																																																																									
3:	9.6	→																																																																									
4:	9.1	→																																																																									
5:	9.2	↓																																																																									
6:	8.7	↓																																																																									
7:	9.8	←																																																																									
8:	9.4	→																																																																									
9:	10.4x	↑																																																																									
10:	10.1	→																																																																									
Series		92 (2x)																																																																									
		0 (0x)																																																																									
11:	10.8x	↙																																																																									
12:	10.2	↘																																																																									
13:	9.6	→																																																																									
14:	10.5x	↘																																																																									
15:	9.0	→																																																																									
16:	9.8	←																																																																									
Series		57 (2x)																																																																									
		0 (0x)																																																																									
<p>60 Shots</p> 	<table border="1" style="width:100%; border-collapse: collapse;"> <tr><td>1:</td><td>9.9</td><td>↑</td></tr> <tr><td>2:</td><td>10.2</td><td>↑</td></tr> <tr><td>3:</td><td>8.7</td><td>↓</td></tr> <tr><td>4:</td><td>9.5</td><td>←</td></tr> <tr><td>5:</td><td>10.4x</td><td>↑</td></tr> <tr><td>6:</td><td>9.9</td><td>↓</td></tr> <tr><td>7:</td><td>9.4</td><td>→</td></tr> <tr><td>8:</td><td>10.2</td><td>→</td></tr> <tr><td>9:</td><td>10.1</td><td>↓</td></tr> <tr><td>10:</td><td>10.5x</td><td>→</td></tr> <tr><td colspan="2">Series</td><td>94 (2x)</td></tr> <tr><td colspan="2"></td><td>94 (2x)</td></tr> </table>	1:	9.9	↑	2:	10.2	↑	3:	8.7	↓	4:	9.5	←	5:	10.4x	↑	6:	9.9	↓	7:	9.4	→	8:	10.2	→	9:	10.1	↓	10:	10.5x	→	Series		94 (2x)			94 (2x)	<p>60 Shots</p> 	<table border="1" style="width:100%; border-collapse: collapse;"> <tr><td>11:</td><td>10.0</td><td>→</td></tr> <tr><td>12:</td><td>9.6</td><td>↗</td></tr> <tr><td>13:</td><td>10.0</td><td>↗</td></tr> <tr><td>14:</td><td>9.9</td><td>←</td></tr> <tr><td>15:</td><td>9.8</td><td>↓</td></tr> <tr><td>16:</td><td>10.1</td><td>→</td></tr> <tr><td>17:</td><td>10.1</td><td>←</td></tr> <tr><td>18:</td><td>9.8</td><td>←</td></tr> <tr><td>19:</td><td>10.0</td><td>↖</td></tr> <tr><td>20:</td><td>10.3</td><td>↘</td></tr> <tr><td colspan="2">Series</td><td>96 (0x)</td></tr> <tr><td colspan="2"></td><td>190 (2x)</td></tr> </table>	11:	10.0	→	12:	9.6	↗	13:	10.0	↗	14:	9.9	←	15:	9.8	↓	16:	10.1	→	17:	10.1	←	18:	9.8	←	19:	10.0	↖	20:	10.3	↘	Series		96 (0x)			190 (2x)
1:	9.9	↑																																																																									
2:	10.2	↑																																																																									
3:	8.7	↓																																																																									
4:	9.5	←																																																																									
5:	10.4x	↑																																																																									
6:	9.9	↓																																																																									
7:	9.4	→																																																																									
8:	10.2	→																																																																									
9:	10.1	↓																																																																									
10:	10.5x	→																																																																									
Series		94 (2x)																																																																									
		94 (2x)																																																																									
11:	10.0	→																																																																									
12:	9.6	↗																																																																									
13:	10.0	↗																																																																									
14:	9.9	←																																																																									
15:	9.8	↓																																																																									
16:	10.1	→																																																																									
17:	10.1	←																																																																									
18:	9.8	←																																																																									
19:	10.0	↖																																																																									
20:	10.3	↘																																																																									
Series		96 (0x)																																																																									
		190 (2x)																																																																									
<p>60 Shots</p> 	<table border="1" style="width:100%; border-collapse: collapse;"> <tr><td>21:</td><td>10.4x</td><td>←</td></tr> <tr><td>22:</td><td>9.8</td><td>←</td></tr> <tr><td>23:</td><td>9.2</td><td>↓</td></tr> <tr><td>24:</td><td>9.3</td><td>↗</td></tr> <tr><td>25:</td><td>10.9x</td><td>↑</td></tr> <tr><td>26:</td><td>10.1</td><td>↘</td></tr> <tr><td>27:</td><td>10.0</td><td>←</td></tr> <tr><td>28:</td><td>9.3</td><td>↓</td></tr> <tr><td>29:</td><td>10.1</td><td>↓</td></tr> <tr><td>30:</td><td>10.7x</td><td>↑</td></tr> <tr><td colspan="2">Series</td><td>96 (3x)</td></tr> <tr><td colspan="2"></td><td>286 (5x)</td></tr> </table>	21:	10.4x	←	22:	9.8	←	23:	9.2	↓	24:	9.3	↗	25:	10.9x	↑	26:	10.1	↘	27:	10.0	←	28:	9.3	↓	29:	10.1	↓	30:	10.7x	↑	Series		96 (3x)			286 (5x)	<p>60 Shots</p> 	<table border="1" style="width:100%; border-collapse: collapse;"> <tr><td>31:</td><td>9.5</td><td>↗</td></tr> <tr><td>32:</td><td>9.8</td><td>↑</td></tr> <tr><td>33:</td><td>8.7</td><td>←</td></tr> <tr><td>34:</td><td>10.2</td><td>←</td></tr> <tr><td>35:</td><td>10.2</td><td>←</td></tr> <tr><td>36:</td><td>9.0</td><td>↘</td></tr> <tr><td>37:</td><td>9.6</td><td>←</td></tr> <tr><td>38:</td><td>10.8x</td><td>→</td></tr> <tr><td>39:</td><td>10.9x</td><td>↘</td></tr> <tr><td>40:</td><td>9.6</td><td>↓</td></tr> <tr><td colspan="2">Series</td><td>93 (2x)</td></tr> <tr><td colspan="2"></td><td>379 (7x)</td></tr> </table>	31:	9.5	↗	32:	9.8	↑	33:	8.7	←	34:	10.2	←	35:	10.2	←	36:	9.0	↘	37:	9.6	←	38:	10.8x	→	39:	10.9x	↘	40:	9.6	↓	Series		93 (2x)			379 (7x)
21:	10.4x	←																																																																									
22:	9.8	←																																																																									
23:	9.2	↓																																																																									
24:	9.3	↗																																																																									
25:	10.9x	↑																																																																									
26:	10.1	↘																																																																									
27:	10.0	←																																																																									
28:	9.3	↓																																																																									
29:	10.1	↓																																																																									
30:	10.7x	↑																																																																									
Series		96 (3x)																																																																									
		286 (5x)																																																																									
31:	9.5	↗																																																																									
32:	9.8	↑																																																																									
33:	8.7	←																																																																									
34:	10.2	←																																																																									
35:	10.2	←																																																																									
36:	9.0	↘																																																																									
37:	9.6	←																																																																									
38:	10.8x	→																																																																									
39:	10.9x	↘																																																																									
40:	9.6	↓																																																																									
Series		93 (2x)																																																																									
		379 (7x)																																																																									
<p>60 Shots</p> 	<table border="1" style="width:100%; border-collapse: collapse;"> <tr><td>41:</td><td>9.7</td><td>→</td></tr> <tr><td>42:</td><td>9.2</td><td>←</td></tr> <tr><td>43:</td><td>10.1</td><td>←</td></tr> <tr><td>44:</td><td>9.9</td><td>↗</td></tr> <tr><td>45:</td><td>9.7</td><td>←</td></tr> <tr><td>46:</td><td>10.4x</td><td>←</td></tr> <tr><td>47:</td><td>10.5x</td><td>↖</td></tr> <tr><td>48:</td><td>8.4</td><td>↓</td></tr> <tr><td>49:</td><td>8.6</td><td>←</td></tr> <tr><td>50:</td><td>9.4</td><td>←</td></tr> <tr><td colspan="2">Series</td><td>91 (2x)</td></tr> <tr><td colspan="2"></td><td>470 (9x)</td></tr> </table>	41:	9.7	→	42:	9.2	←	43:	10.1	←	44:	9.9	↗	45:	9.7	←	46:	10.4x	←	47:	10.5x	↖	48:	8.4	↓	49:	8.6	←	50:	9.4	←	Series		91 (2x)			470 (9x)	<p>60 Shots</p> 	<table border="1" style="width:100%; border-collapse: collapse;"> <tr><td>51:</td><td>9.0</td><td>↑</td></tr> <tr><td>52:</td><td>9.1</td><td>↖</td></tr> <tr><td>53:</td><td>9.7</td><td>↓</td></tr> <tr><td>54:</td><td>10.7x</td><td>↘</td></tr> <tr><td>55:</td><td>10.7x</td><td>↓</td></tr> <tr><td>56:</td><td>10.1</td><td>↓</td></tr> <tr><td>57:</td><td>8.3</td><td>←</td></tr> <tr><td>58:</td><td>8.9</td><td>←</td></tr> <tr><td>59:</td><td>8.9</td><td>↘</td></tr> <tr><td>60:</td><td>9.1</td><td>↘</td></tr> <tr><td colspan="2">Series</td><td>90 (2x)</td></tr> <tr><td colspan="2"></td><td>560 (11x)</td></tr> </table>	51:	9.0	↑	52:	9.1	↖	53:	9.7	↓	54:	10.7x	↘	55:	10.7x	↓	56:	10.1	↓	57:	8.3	←	58:	8.9	←	59:	8.9	↘	60:	9.1	↘	Series		90 (2x)			560 (11x)
41:	9.7	→																																																																									
42:	9.2	←																																																																									
43:	10.1	←																																																																									
44:	9.9	↗																																																																									
45:	9.7	←																																																																									
46:	10.4x	←																																																																									
47:	10.5x	↖																																																																									
48:	8.4	↓																																																																									
49:	8.6	←																																																																									
50:	9.4	←																																																																									
Series		91 (2x)																																																																									
		470 (9x)																																																																									
51:	9.0	↑																																																																									
52:	9.1	↖																																																																									
53:	9.7	↓																																																																									
54:	10.7x	↘																																																																									
55:	10.7x	↓																																																																									
56:	10.1	↓																																																																									
57:	8.3	←																																																																									
58:	8.9	←																																																																									
59:	8.9	↘																																																																									
60:	9.1	↘																																																																									
Series		90 (2x)																																																																									
		560 (11x)																																																																									

Comment	Signature
---------	-----------

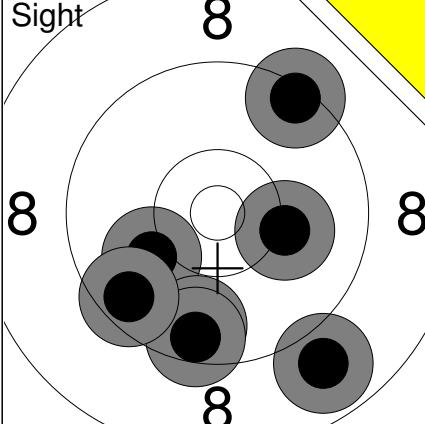
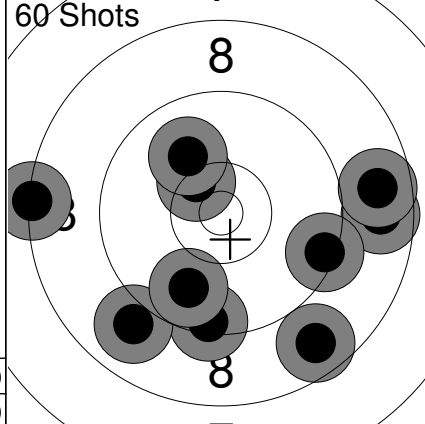
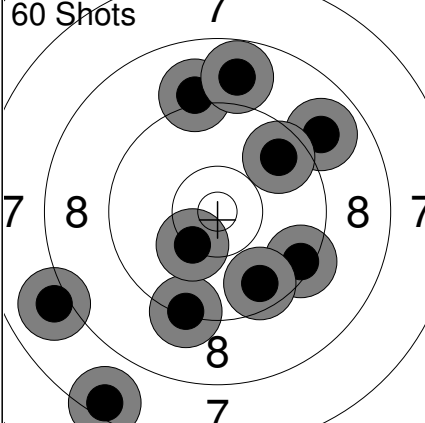
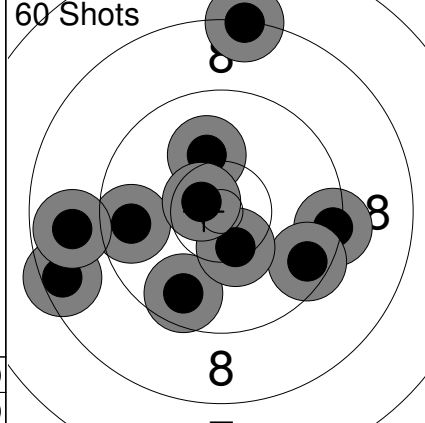
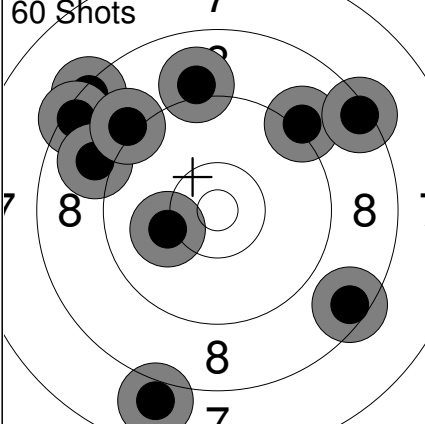
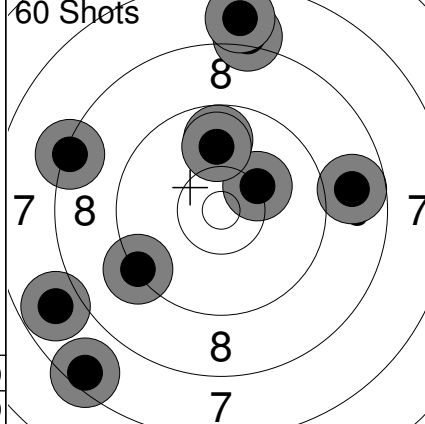
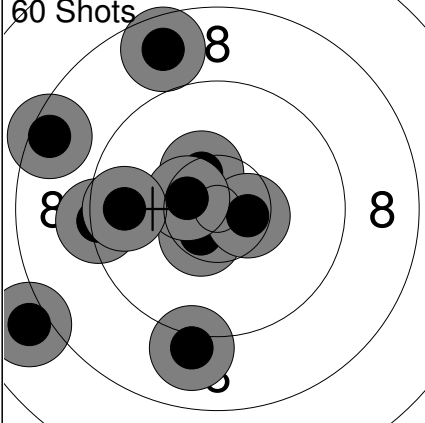
<p>Sight</p> 	<p>1: 10.1 ↙ 2: 9.7 ↓ 3: 9.4 ↗ 4: 8.9 ↓ 5: 9.5 ↓ 6: 9.6 ↙ 7: 10.2 →</p>	<p>60 Shots</p> 	<p>1: 8.7 ↓ 2: 8.7 → 3: 9.4 ↓ 4: 9.0 ↙ 5: 9.8 ↓ 6: 9.4 → 7: 10.4x ↗ 8: 8.7 → 9: 8.3 ← 10: 10.0 ↗</p>
	Series 64 (0x) 0 (0x)		Series 88 (1x) 88 (1x)
<p>60 Shots</p> 	<p>11: 8.9 ↗ 12: 7.5 ↓ 13: 9.1 ↗ 14: 9.3 ↓ 15: 8.8 ↗ 16: 9.4 → 17: 8.0 ↙ 18: 9.7 ↗ 19: 9.6 ↓ 20: 10.3 ↓</p>	<p>60 Shots</p> 	<p>21: 9.7 ← 22: 9.4 → 23: 9.5 ↗ 24: 10.1 ↗ 25: 8.5 ← 26: 9.7 ↓ 27: 8.3 ↗ 28: 10.4x ↓ 29: 10.6x ↙ 30: 8.8 ←</p>
	Series 86 (0x) 174 (1x)		Series 90 (2x) 264 (3x)
<p>60 Shots</p> 	<p>31: 9.1 ↗ 32: 8.3 ↗ 33: 8.4 ↗ 34: 9.0 ↗ 35: 10.1 ← 36: 7.9 ↓ 37: 8.4 ↗ 38: 9.0 ↗ 39: 9.1 ↗ 40: 8.5 ↓</p>	<p>60 Shots</p> 	<p>41: 10.2 ↗ 42: 8.8 → 43: 8.3 ← 44: 8.1 ↗ 45: 7.8 ↙ 46: 9.3 ↙ 47: 7.8 ↗ 48: 7.5 ↙ 49: 9.8 ↗ 50: 9.9 ↗</p>
	Series 85 (0x) 349 (3x)		Series 82 (0x) 431 (3x)
<p>60 Shots</p> 	<p>51: 9.0 ↓ 52: 10.5x ↓ 53: 10.4x ↗ 54: 8.7 ↗ 55: 10.5x → 56: 9.3 ← 57: 8.0 ← 58: 10.5x ← 59: 9.7 ← 60: 8.5 ↙</p>		
	Series 91 (4x) 522 (7x)		

Relay 2	Lane 19	VASILEVA Yanka
-------------------	-------------------	-----------------------

2023 SFC Pistol Nationals	QC	MA	WP
---------------------------	----	----	----

15.07.2023	PN23AP-Q-1	Alberta Handgun Association
------------	------------	-----------------------------

Comment	Signature
---------	-----------

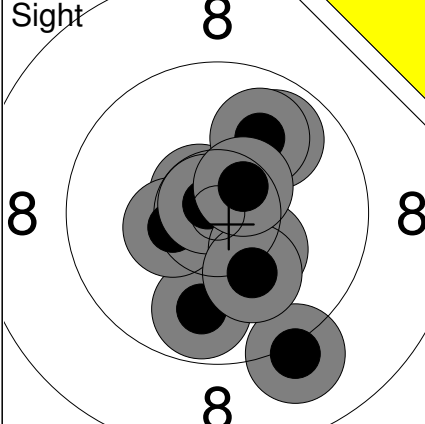
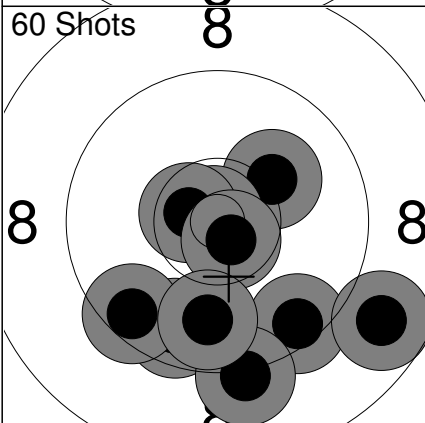
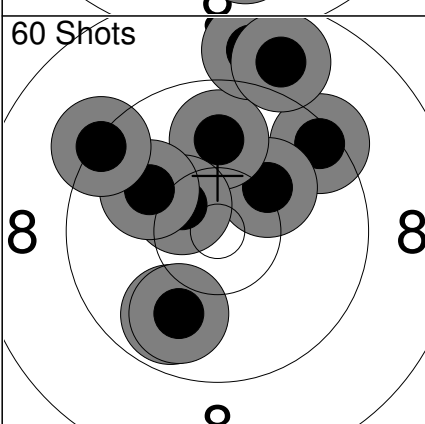
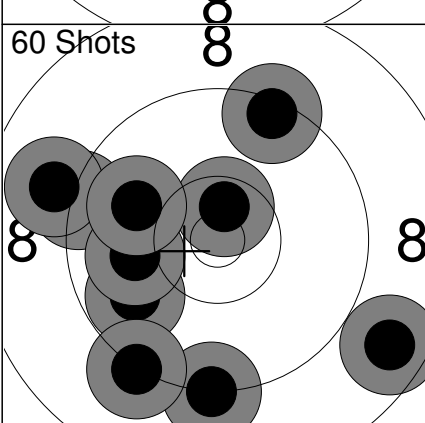
<p>Sight</p> 	<p>60 Shots</p> 	<p>60 Shots</p> 	<p>60 Shots</p> 																																																																																																																									
<table border="1" style="width:100%; border-collapse: collapse;"> <tr><td>1: 10.6x</td><td>↗</td></tr> <tr><td>2: 9.9</td><td>↗</td></tr> <tr><td>3: 9.8</td><td>↘</td></tr> <tr><td>4: 10.4x</td><td>↖</td></tr> <tr><td>5: 9.1</td><td>↘</td></tr> <tr><td>6: 10.0</td><td>↗</td></tr> <tr><td>7: 10.8x</td><td>↗</td></tr> <tr><td>8: 10.3</td><td>↘</td></tr> <tr><td>9: 10.2</td><td>↘</td></tr> <tr><td>10: 10.5x</td><td>↗</td></tr> <tr><td>Series</td><td>97 (4x)</td></tr> <tr><td></td><td>0 (0x)</td></tr> </table>	1: 10.6x	↗	2: 9.9	↗	3: 9.8	↘	4: 10.4x	↖	5: 9.1	↘	6: 10.0	↗	7: 10.8x	↗	8: 10.3	↘	9: 10.2	↘	10: 10.5x	↗	Series	97 (4x)		0 (0x)	<table border="1" style="width:100%; border-collapse: collapse;"> <tr><td>11: 10.2</td><td>↗</td></tr> <tr><td>12: 9.6</td><td>↘</td></tr> <tr><td>13: 9.5</td><td>↘</td></tr> <tr><td>14: 9.5</td><td>↖</td></tr> <tr><td>15: 9.2</td><td>↘</td></tr> <tr><td>16: 10.9x</td><td>↗</td></tr> <tr><td>17: 10.6x</td><td>↗</td></tr> <tr><td>18: 10.7x</td><td>↘</td></tr> <tr><td>19: 9.8</td><td>↘</td></tr> <tr><td>20: 8.8</td><td>↘</td></tr> <tr><td>Series</td><td>93 (3x)</td></tr> <tr><td></td><td>186 (4x)</td></tr> </table>	11: 10.2	↗	12: 9.6	↘	13: 9.5	↘	14: 9.5	↖	15: 9.2	↘	16: 10.9x	↗	17: 10.6x	↗	18: 10.7x	↘	19: 9.8	↘	20: 8.8	↘	Series	93 (3x)		186 (4x)	<table border="1" style="width:100%; border-collapse: collapse;"> <tr><td>21: 10.2</td><td>↖</td></tr> <tr><td>22: 9.5</td><td>↘</td></tr> <tr><td>23: 10.3</td><td>→</td></tr> <tr><td>24: 9.5</td><td>↘</td></tr> <tr><td>25: 10.1</td><td>↖</td></tr> <tr><td>26: 10.3</td><td>↗</td></tr> <tr><td>27: 10.7x</td><td>↖</td></tr> <tr><td>28: 10.5x</td><td>↘</td></tr> <tr><td>29: 10.3</td><td>↗</td></tr> <tr><td>30: 9.8</td><td>↖</td></tr> <tr><td>Series</td><td>97 (2x)</td></tr> <tr><td></td><td>283 (6x)</td></tr> </table>	21: 10.2	↖	22: 9.5	↘	23: 10.3	→	24: 9.5	↘	25: 10.1	↖	26: 10.3	↗	27: 10.7x	↖	28: 10.5x	↘	29: 10.3	↗	30: 9.8	↖	Series	97 (2x)		283 (6x)	<table border="1" style="width:100%; border-collapse: collapse;"> <tr><td>31: 9.4</td><td>↗</td></tr> <tr><td>32: 9.9</td><td>↘</td></tr> <tr><td>33: 10.2</td><td>↗</td></tr> <tr><td>34: 9.9</td><td>↗</td></tr> <tr><td>35: 10.5x</td><td>↗</td></tr> <tr><td>36: 10.0</td><td>↗</td></tr> <tr><td>37: 9.9</td><td>↘</td></tr> <tr><td>38: 9.3</td><td>↗</td></tr> <tr><td>39: 8.8</td><td>↗</td></tr> <tr><td>40: 8.9</td><td>↗</td></tr> <tr><td>Series</td><td>91 (1x)</td></tr> <tr><td></td><td>374 (7x)</td></tr> </table>	31: 9.4	↗	32: 9.9	↘	33: 10.2	↗	34: 9.9	↗	35: 10.5x	↗	36: 10.0	↗	37: 9.9	↘	38: 9.3	↗	39: 8.8	↗	40: 8.9	↗	Series	91 (1x)		374 (7x)	<table border="1" style="width:100%; border-collapse: collapse;"> <tr><td>41: 10.0</td><td>↘</td></tr> <tr><td>42: 9.7</td><td>↗</td></tr> <tr><td>43: 9.7</td><td>↘</td></tr> <tr><td>44: 10.2</td><td>↘</td></tr> <tr><td>45: 10.0</td><td>↘</td></tr> <tr><td>46: 9.3</td><td>↖</td></tr> <tr><td>47: 9.7</td><td>↗</td></tr> <tr><td>48: 10.0</td><td>↘</td></tr> <tr><td>49: 10.4x</td><td>↗</td></tr> <tr><td>50: 9.4</td><td>↗</td></tr> <tr><td>Series</td><td>95 (1x)</td></tr> <tr><td></td><td>469 (8x)</td></tr> </table>	41: 10.0	↘	42: 9.7	↗	43: 9.7	↘	44: 10.2	↘	45: 10.0	↘	46: 9.3	↖	47: 9.7	↗	48: 10.0	↘	49: 10.4x	↗	50: 9.4	↗	Series	95 (1x)		469 (8x)
1: 10.6x	↗																																																																																																																											
2: 9.9	↗																																																																																																																											
3: 9.8	↘																																																																																																																											
4: 10.4x	↖																																																																																																																											
5: 9.1	↘																																																																																																																											
6: 10.0	↗																																																																																																																											
7: 10.8x	↗																																																																																																																											
8: 10.3	↘																																																																																																																											
9: 10.2	↘																																																																																																																											
10: 10.5x	↗																																																																																																																											
Series	97 (4x)																																																																																																																											
	0 (0x)																																																																																																																											
11: 10.2	↗																																																																																																																											
12: 9.6	↘																																																																																																																											
13: 9.5	↘																																																																																																																											
14: 9.5	↖																																																																																																																											
15: 9.2	↘																																																																																																																											
16: 10.9x	↗																																																																																																																											
17: 10.6x	↗																																																																																																																											
18: 10.7x	↘																																																																																																																											
19: 9.8	↘																																																																																																																											
20: 8.8	↘																																																																																																																											
Series	93 (3x)																																																																																																																											
	186 (4x)																																																																																																																											
21: 10.2	↖																																																																																																																											
22: 9.5	↘																																																																																																																											
23: 10.3	→																																																																																																																											
24: 9.5	↘																																																																																																																											
25: 10.1	↖																																																																																																																											
26: 10.3	↗																																																																																																																											
27: 10.7x	↖																																																																																																																											
28: 10.5x	↘																																																																																																																											
29: 10.3	↗																																																																																																																											
30: 9.8	↖																																																																																																																											
Series	97 (2x)																																																																																																																											
	283 (6x)																																																																																																																											
31: 9.4	↗																																																																																																																											
32: 9.9	↘																																																																																																																											
33: 10.2	↗																																																																																																																											
34: 9.9	↗																																																																																																																											
35: 10.5x	↗																																																																																																																											
36: 10.0	↗																																																																																																																											
37: 9.9	↘																																																																																																																											
38: 9.3	↗																																																																																																																											
39: 8.8	↗																																																																																																																											
40: 8.9	↗																																																																																																																											
Series	91 (1x)																																																																																																																											
	374 (7x)																																																																																																																											
41: 10.0	↘																																																																																																																											
42: 9.7	↗																																																																																																																											
43: 9.7	↘																																																																																																																											
44: 10.2	↘																																																																																																																											
45: 10.0	↘																																																																																																																											
46: 9.3	↖																																																																																																																											
47: 9.7	↗																																																																																																																											
48: 10.0	↘																																																																																																																											
49: 10.4x	↗																																																																																																																											
50: 9.4	↗																																																																																																																											
Series	95 (1x)																																																																																																																											
	469 (8x)																																																																																																																											
<table border="1" style="width:100%; border-collapse: collapse;"> <tr><td>51: 9.2</td><td>↘</td></tr> <tr><td>52: 9.3</td><td>↖</td></tr> <tr><td>53: 8.7</td><td>↘</td></tr> <tr><td>54: 9.8</td><td>↖</td></tr> <tr><td>55: 9.0</td><td>↖</td></tr> <tr><td>56: 9.2</td><td>↘</td></tr> <tr><td>57: 10.0</td><td>↖</td></tr> <tr><td>58: 10.6x</td><td>↗</td></tr> <tr><td>59: 9.4</td><td>↗</td></tr> <tr><td>60: 10.0</td><td>↖</td></tr> <tr><td>Series</td><td>92 (1x)</td></tr> <tr><td></td><td>561 (9x)</td></tr> </table>	51: 9.2	↘	52: 9.3	↖	53: 8.7	↘	54: 9.8	↖	55: 9.0	↖	56: 9.2	↘	57: 10.0	↖	58: 10.6x	↗	59: 9.4	↗	60: 10.0	↖	Series	92 (1x)		561 (9x)																																																																																																				
51: 9.2	↘																																																																																																																											
52: 9.3	↖																																																																																																																											
53: 8.7	↘																																																																																																																											
54: 9.8	↖																																																																																																																											
55: 9.0	↖																																																																																																																											
56: 9.2	↘																																																																																																																											
57: 10.0	↖																																																																																																																											
58: 10.6x	↗																																																																																																																											
59: 9.4	↗																																																																																																																											
60: 10.0	↖																																																																																																																											
Series	92 (1x)																																																																																																																											
	561 (9x)																																																																																																																											

Relay 2	Lane 20	LI Ethan
-------------------	-------------------	-----------------

2023 SFC Pistol Nationals	IJ	MP
---------------------------	----	----

15.07.2023	PN23AP-Q-1	Alberta Handgun Association
------------	------------	-----------------------------

Comment	Signature
---------	-----------

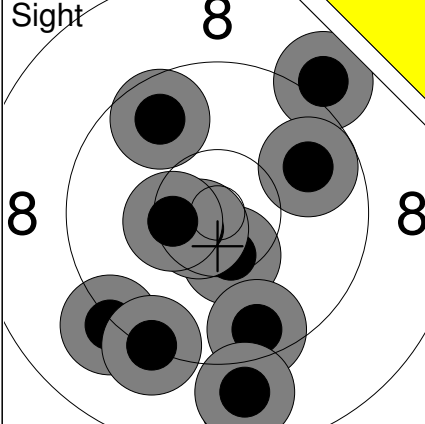
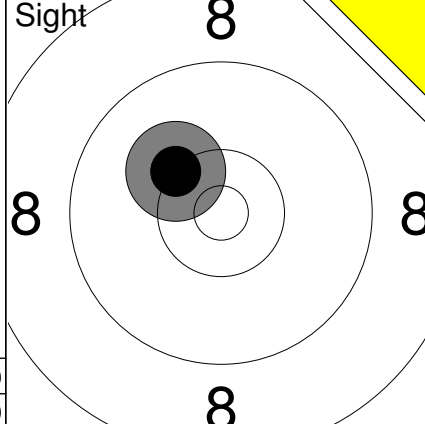
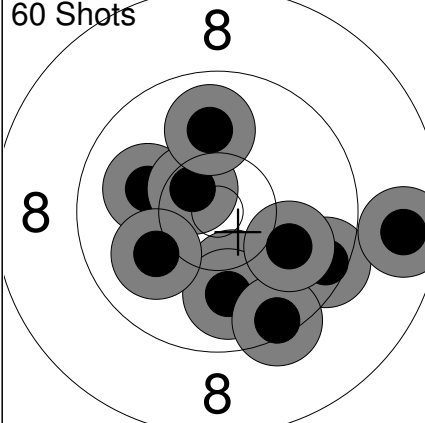
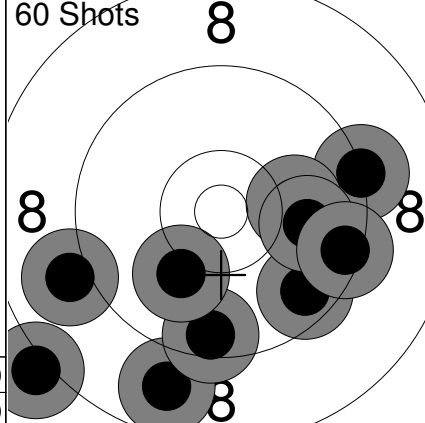
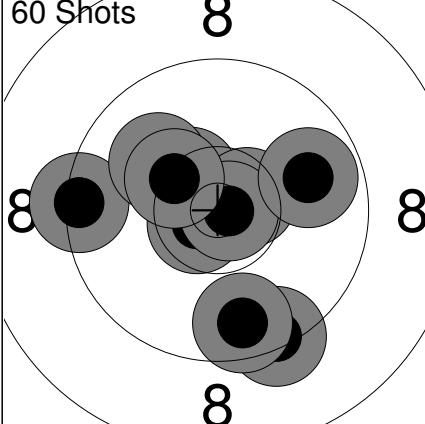
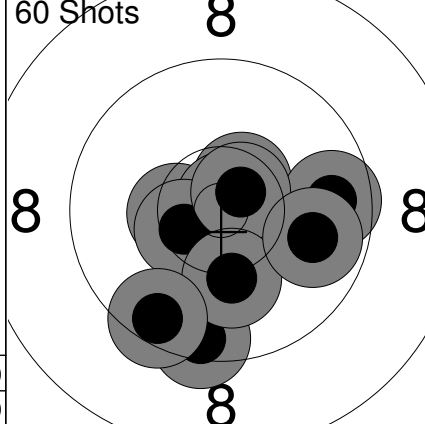
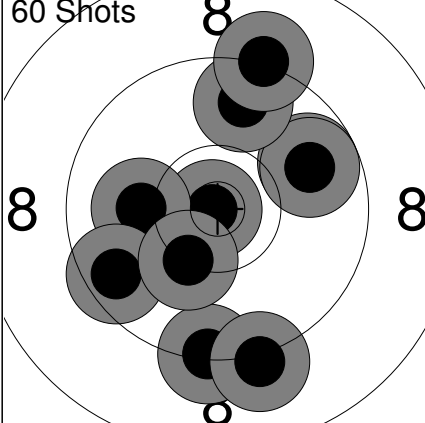
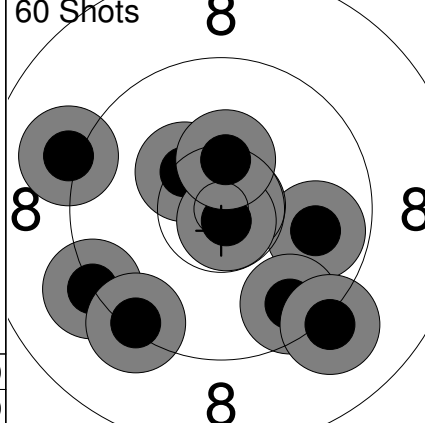
<p>Sight</p> 	<p>1: 9.2 ↙ 2: 9.0 ↗ 3: 10.4x ↓ 4: 9.8 → 5: 10.7x ↙ 6: 9.7 ↗ 7: 9.6 ↓ 8: 9.3 ↓ 9: 8.9 ↓ 10: 10.4x ←</p> <p>Series 92 (3x) 0 (0x)</p>	<p>Sight</p> 	<p>11: 10.3 ↗</p> <p>Series 10 (0x) 0 (0x)</p>
<p>60 Shots</p> 	<p>1: 10.2 ↓ 2: 10.1 ↗ 3: 9.9 ↓ 4: 10.5x ↗ 5: 10.0 ↙ 6: 9.5 ↓ 7: 9.9 ↗ 8: 9.4 ↓ 9: 10.0 ↓ 10: 8.7 →</p> <p>Series 94 (1x) 94 (1x)</p>	<p>60 Shots</p> 	<p>11: 8.8 ↓ 12: 9.6 ↘ 13: 9.0 ← 14: 9.2 → 15: 9.5 ↓ 16: 10.1 → 17: 9.9 → 18: 10.1 ↓ 19: 9.4 → 20: 8.1 ↙</p> <p>Series 90 (0x) 184 (1x)</p>
<p>60 Shots</p> 	<p>21: 10.5x ↗ 22: 10.7x ↙ 23: 9.4 ↓ 24: 10.6x → 25: 9.4 ← 26: 9.6 ↓ 27: 10.8x → 28: 10.1 ↗ 29: 9.9 → 30: 10.3 ↗</p> <p>Series 96 (4x) 280 (5x)</p>	<p>60 Shots</p> 	<p>31: 10.4x ← 32: 10.6x ↗ 33: 10.8x ↗ 34: 9.7 → 35: 10.5x ↙ 36: 10.6x ↗ 37: 9.5 ↓ 38: 10.2 ↓ 39: 9.5 ↓ 40: 9.9 →</p> <p>Series 96 (5x) 376 (10x)</p>
<p>60 Shots</p> 	<p>41: 9.8 → 42: 9.8 → 43: 10.9x ← 44: 9.3 ↓ 45: 9.1 ↓ 46: 10.1 ← 47: 9.6 ↙ 48: 10.3 ↓ 49: 9.7 ↗ 50: 9.2 ↗</p> <p>Series 93 (1x) 469 (11x)</p>	<p>60 Shots</p> 	<p>51: 9.8 → 52: 10.8x → 53: 9.6 ↓ 54: 10.4x ↗ 55: 10.8x ↓ 56: 9.2 ↙ 57: 9.1 ↙ 58: 9.3 ↓ 59: 10.4x ↗ 60: 9.1 ↓</p> <p>Series 94 (4x) 563 (15x)</p>

Comment	Signature
---------	-----------

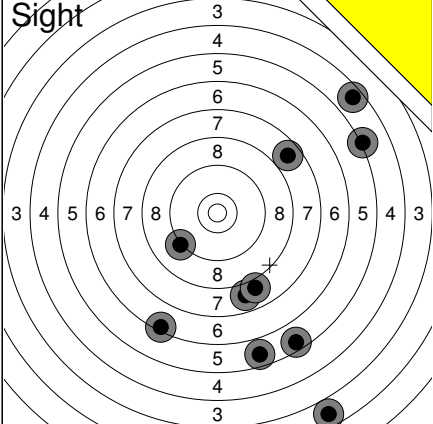
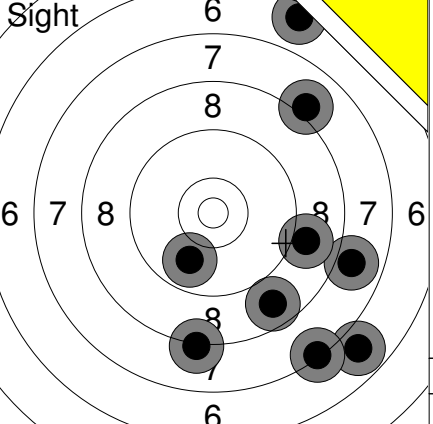
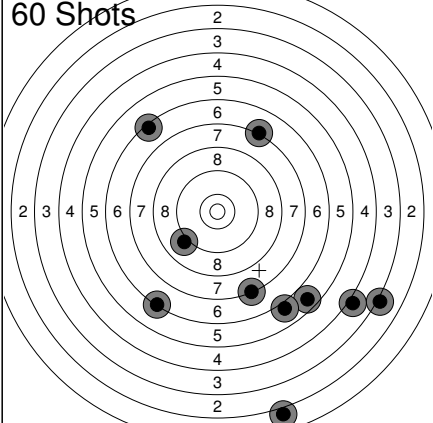
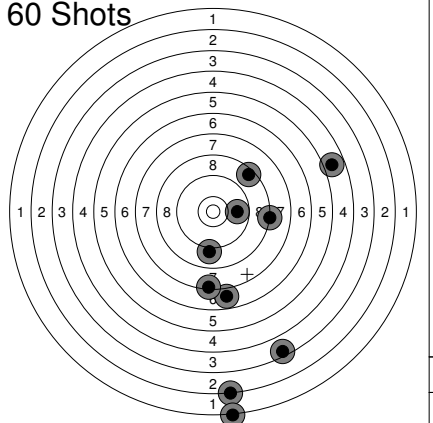
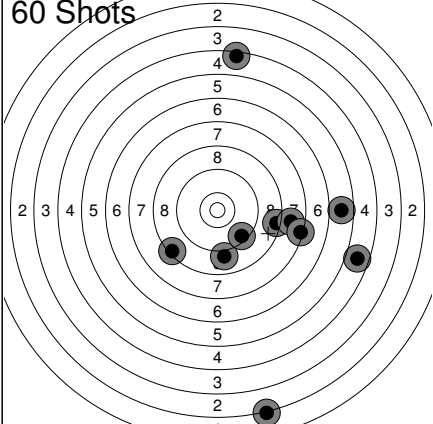
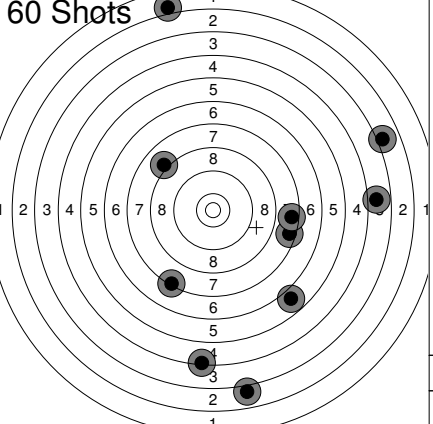
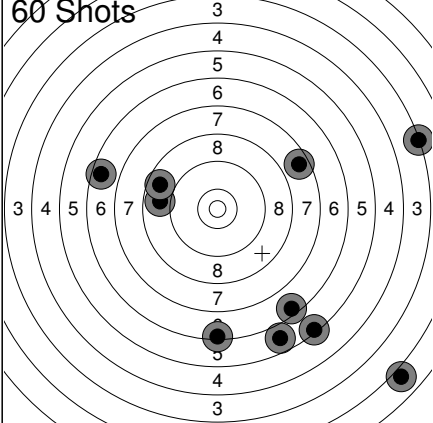
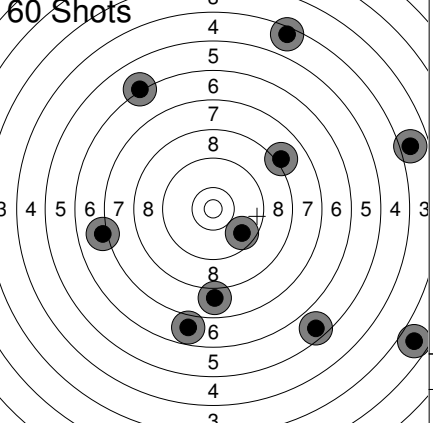
<p>Sight</p> 	<p>1: 7.7 ↗ 2: 7.8 ↓ 3: 6.4 ↓ 4: 9.2 ← 5: 5.1 → 6: 2.7 ↓ 7: 7.9 ↓ 8: 5.5 ↓ 9: 5.7 ↓ 10: 4.6 ↗</p> <p>Series 57 (0x) 0 (0x)</p>	<p>Sight</p> 	<p>11: 9.9 ↓ 12: 8.2 ↓ 13: 7.9 → 14: 6.8 ↓ 15: 6.5 ↑ 16: 8.0 ↗ 17: 7.3 ↓ 18: 8.7 ↓ 19: 8.9 →</p> <p>Series 67 (0x) 0 (0x)</p>
<p>60 Shots</p> 	<p>1: 7.2 ↗ 2: 9.0 ← 3: 3.1 ↓ 4: 2.0 ↓ 5: 6.2 ↓ 6: 7.3 ↓ 7: 4.0 ↓ 8: 6.4 ↗ 9: 5.6 ↓ 10: 6.0 ↓</p> <p>Series 55 (0x) 55 (0x)</p>	<p>60 Shots</p> 	<p>11: 9.0 ↓ 12: 9.8 → 13: 6.8 ↓ 14: 3.5 ↓ 15: 4.8 → 16: 8.2 → 17: 2.2 ↓ 18: 1.2 ↓ 19: 7.3 ↓ 20: 8.5 ↗</p> <p>Series 57 (0x) 112 (0x)</p>
<p>60 Shots</p> 	<p>21: 8.4 → 22: 9.0 ↓ 23: 5.7 → 24: 4.4 ↑ 25: 8.4 ← 26: 7.8 → 27: 2.2 ↓ 28: 4.7 → 29: 9.5 ↓ 30: 7.3 →</p> <p>Series 63 (0x) 175 (0x)</p>	<p>60 Shots</p> 	<p>31: 5.8 ↓ 32: 7.5 → 33: 4.3 ↓ 34: 3.0 ↓ 35: 7.3 ↓ 36: 7.5 → 37: 3.0 → 38: 8.1 ↗ 39: 3.8 → 40: 2.0 ↑</p> <p>Series 49 (0x) 224 (0x)</p>
<p>60 Shots</p> 	<p>41: 5.4 ↓ 42: 6.5 ↓ 43: 1.9 ↓ 44: 8.9 ← 45: 7.6 → 46: 6.6 ↗ 47: 3.3 → 48: 8.7 ↗ 49: 5.8 ↓ 50: 6.3 ↓</p> <p>Series 55 (0x) 279 (0x)</p>	<p>60 Shots</p> 	<p>51: 8.1 ↗ 52: 6.8 ↓ 53: 6.2 ↗ 54: 3.9 → 55: 2.7 ↓ 56: 7.9 ↓ 57: 5.6 ↓ 58: 7.1 ← 59: 9.7 ↓ 60: 4.5 ↑</p> <p>Series 57 (0x) 336 (0x)</p>

Relay **2** Lane **22** **WANG Eddie shihan**

2023 SFC Pistol Nationals BC SJ MP

15.07.2023 PN23AP-Q-1 Alberta Handgun Association

Comment Signature

	1: 9.6 ↗ 2: 9.8 ↘ 3: 10.4x ↗ 4: 9.4 ↗ 5: 9.1 ↗ 6: 8.5 ↑		1: 9.4 ↗ 2: 9.7 → 3: 9.0 ↗ 4: 9.6 ↘ 5: 9.5 ↘ 6: 9.7 ↗ 7: 9.8 ↓ 8: 9.1 → 9: 9.6 → 10: 10.2 ↙
	Series 54 (1x) 0 (0x)		Series 91 (0x) 91 (0x)

	11: 7.8 → 12: 8.9 ↘ 13: 8.7 ↗ 14: 7.5 ↑ 15: 9.6 ↘ 16: 9.8 ↙ 17: 7.6 → 18: 8.9 ↘ 19: 8.8 → 20: 10.5x ↙		21: 9.3 ↗ 22: 10.5x ↑ 23: 10.3 ↗ 24: 8.7 ↘ 25: 8.9 ↑ 26: 9.7 ↑ 27: 7.9 ↑ 28: 8.4 ↗ 29: 9.5 → 30: 10.1 ↑
	Series 81 (1x) 172 (1x)		Series 88 (1x) 260 (2x)

	31: 8.7 ↘ 32: 7.3 → 33: 8.7 ↑ 34: 9.1 ↙ 35: 9.8 ↘ 36: 9.4 ↗ 37: 7.4 ↘ 38: 7.9 ↘ 39: 9.2 → 40: 10.4x ↗		41: 8.8 ↘ 42: 8.0 ↗ 43: 8.2 → 44: 5.5 ↘ 45: 8.5 → 46: 9.5 ↗ 47: 8.0 → 48: 8.1 ↗ 49: 8.9 → 50: 10.1 ↙
	Series 83 (1x) 343 (3x)		Series 80 (0x) 423 (3x)

	51: 8.5 → 52: 8.6 → 53: 9.0 → 54: 8.5 → 55: 9.4 ↗ 56: 8.4 ↑ 57: 9.4 → 58: 8.9 ↘ 59: 8.1 ↘ 60: 10.8x →		
	Series 85 (1x) 508 (4x)		

Relay **2** Lane **23** **PADDA Harvir singh**

2023 SFC Pistol Nationals BC SJ MP

15.07.2023 PN23AP-Q-1 Alberta Handgun Association

Comment Signature

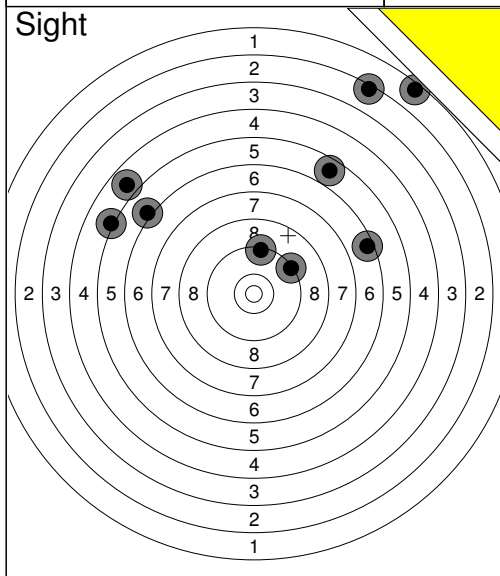

1:	2.4	↗
2:	5.2	↖
3:	9.3	↑
4:	9.3	↗
5:	0.0	↘
6:	6.1	↖
7:	5.7	↗
8:	4.8	↖
9:	1.5	↗
10:	6.5	→
Series	47 (0x)	
	0 (0x)	

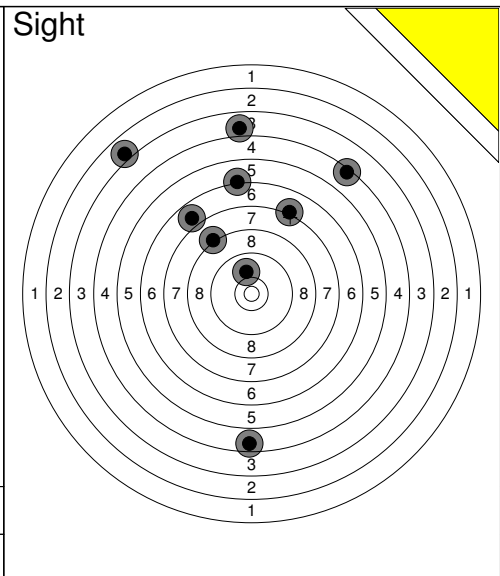

11:	10.0	↑
12:	3.9	↑
13:	8.1	↖
14:	7.1	↗
15:	4.4	↗
16:	6.9	↖
17:	6.2	↑
18:	0.0	→
19:	2.9	↖
20:	4.6	↓
Series	50 (0x)	
	0 (0x)	

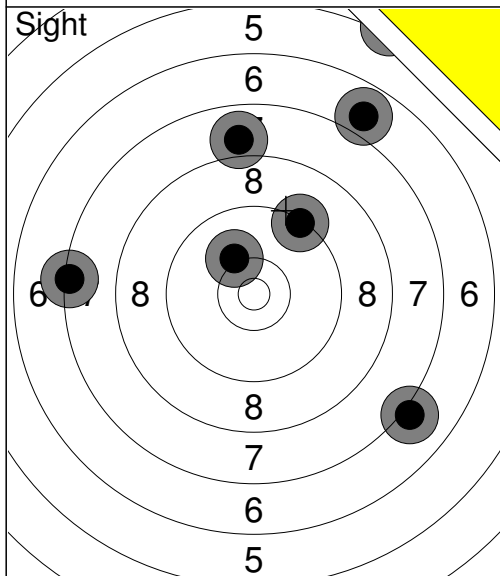

21:	6.9	↗
22:	5.1	↗
23:	7.3	←
24:	7.9	↑
25:	9.3	↗
26:	10.2	↗
27:	7.1	↘
Series	51 (0x)	
	0 (0x)	

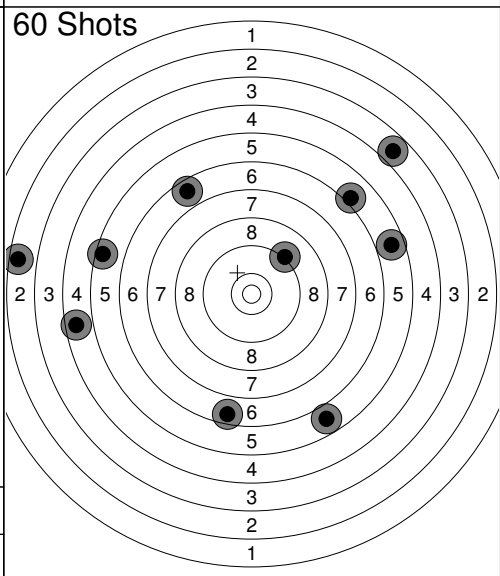

1:	6.6	↖
2:	5.5	←
3:	6.6	↓
4:	5.7	→
5:	5.8	↘
6:	3.8	↗
7:	6.0	↗
8:	4.6	←
9:	2.5	←
10:	9.2	↗
Series	51 (0x)	
	51 (0x)	

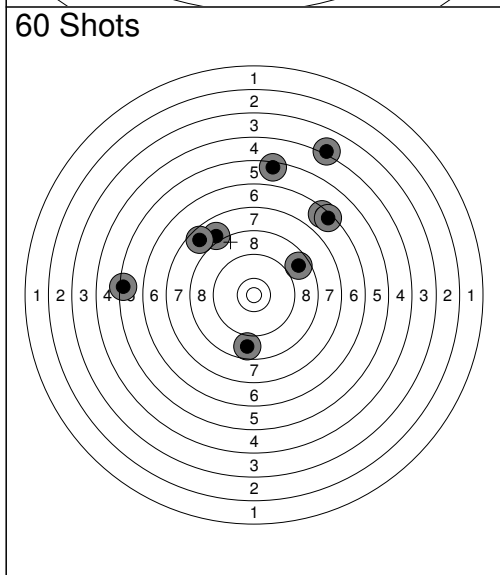

11:	8.7	↗
12:	0.0	←
13:	5.4	←
14:	8.0	↖
15:	6.4	↗
16:	4.1	↗
17:	8.7	↓
18:	5.5	↑
19:	6.4	↗
20:	7.6	↖
Series	57 (0x)	
	108 (0x)	

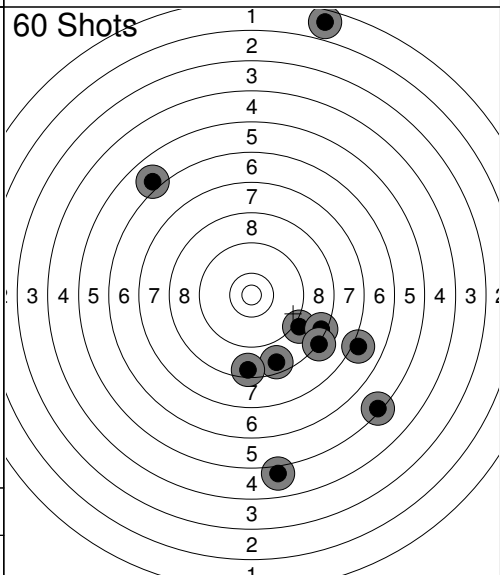

21:	9.1	↘
22:	1.6	↑
23:	8.6	↓
24:	6.0	↗
25:	8.5	↓
26:	8.4	↘
27:	8.2	↘
28:	7.0	↘
29:	5.4	↘
30:	5.0	↓
Series	65 (0x)	
	173 (0x)	

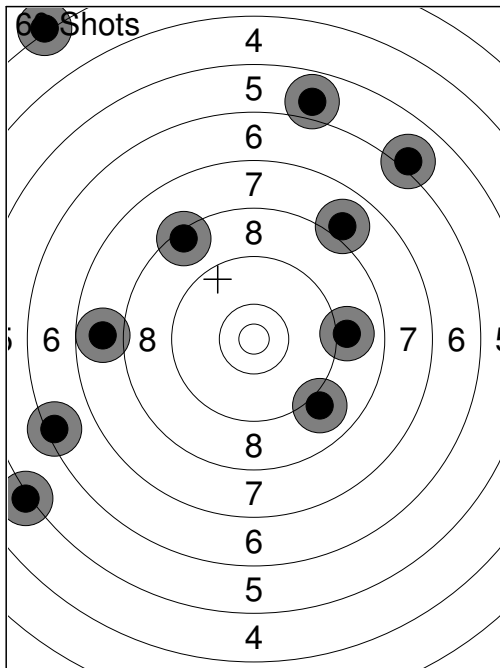

31:	8.4	↖
32:	6.4	←
33:	9.0	→
34:	8.0	↗
35:	7.8	←
36:	6.0	↗
37:	5.9	↑
38:	5.2	←
39:	9.0	↘
40:	3.2	↖
Series	66	(0x)
	239	(0x)

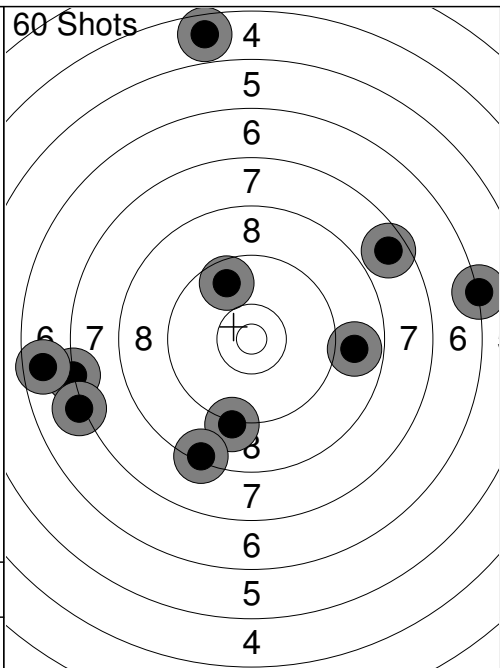

41:	6.2	→
42:	8.8	→
43:	7.2	←
44:	7.1	←
45:	4.6	↑
46:	6.6	←
47:	7.6	↗
48:	9.2	↓
49:	8.3	↓
50:	9.7	↖
Series	71	(0x)
	310	(0x)

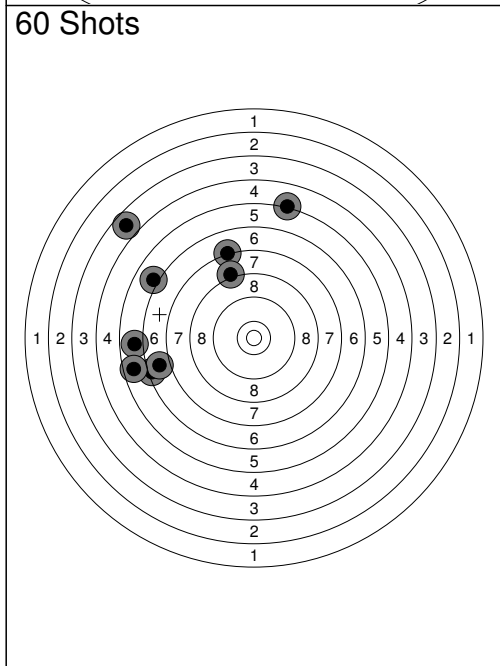

51:	6.0	↖
52:	5.2	↑
53:	7.2	↑
54:	6.4	←
55:	5.9	←
56:	6.8	←
57:	0.0	←
58:	3.7	↖
59:	5.7	←
60:	8.1	↖
Series	51	(0x)
	361	(0x)

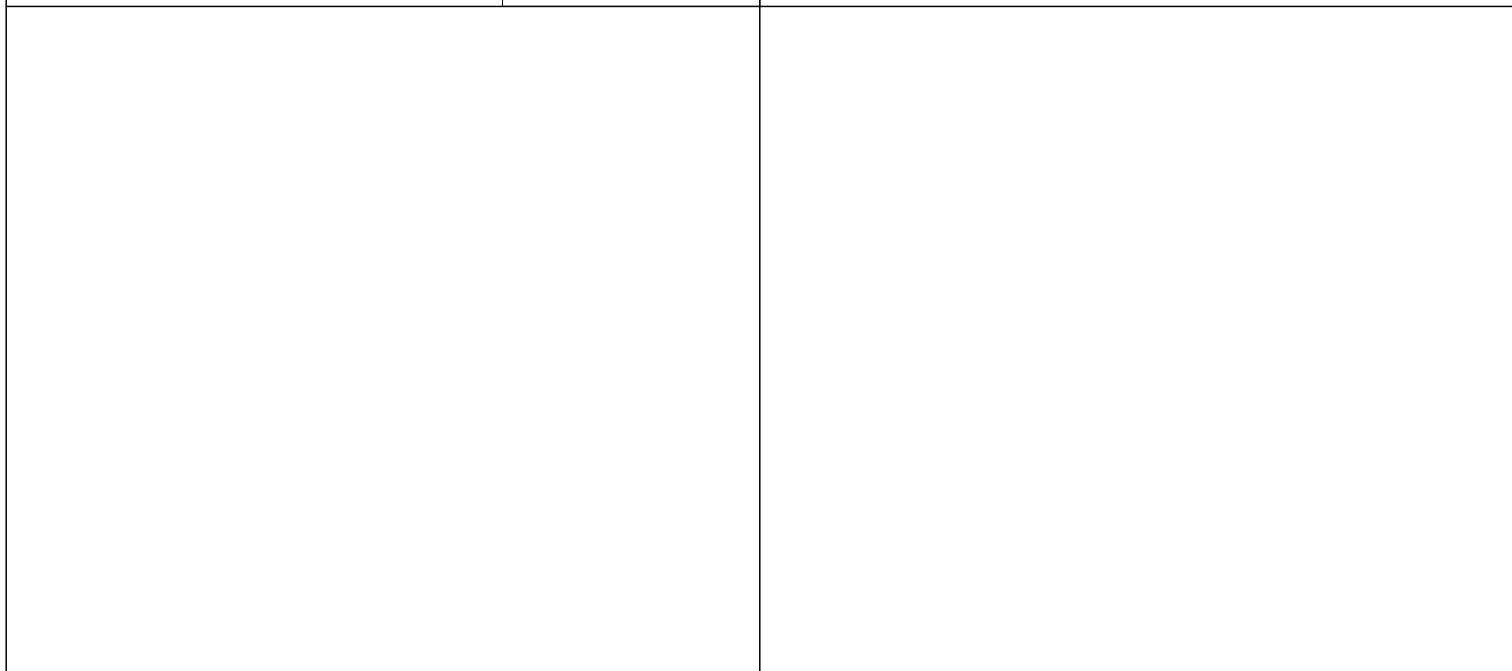

Relay **2** Lane **24** **LUO Max fangzhi**

2023 SFC Pistol Nationals BC SJ MP

15.07.2023 PN23AP-Q-1 Alberta Handgun Association

Comment Signature

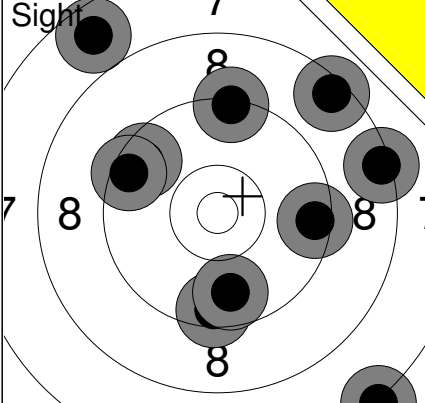
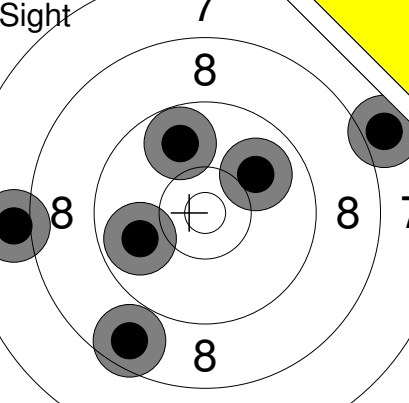
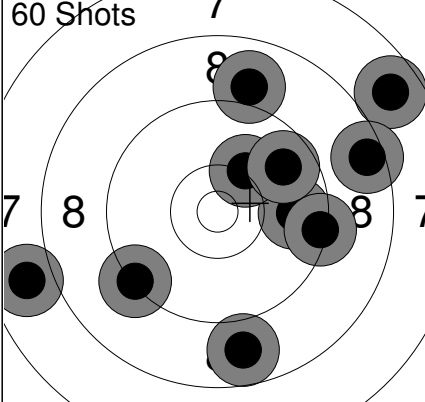
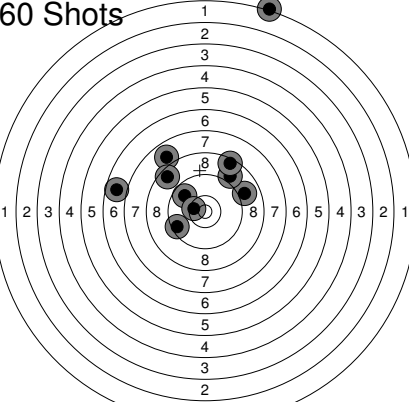
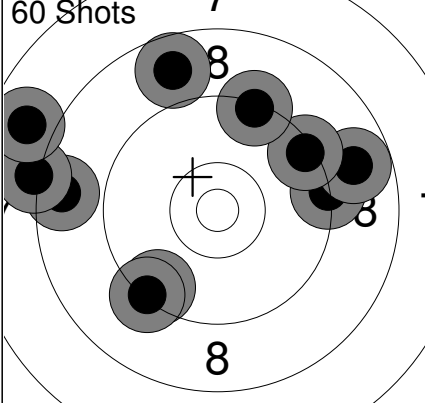
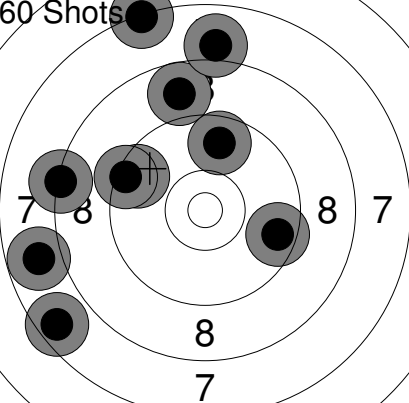
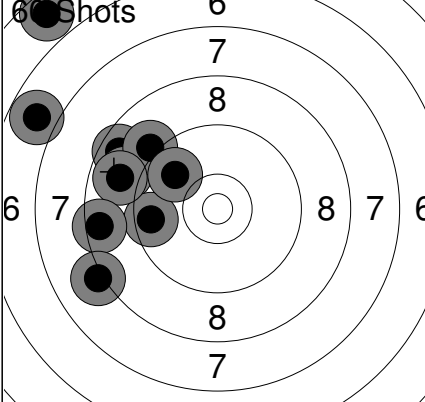
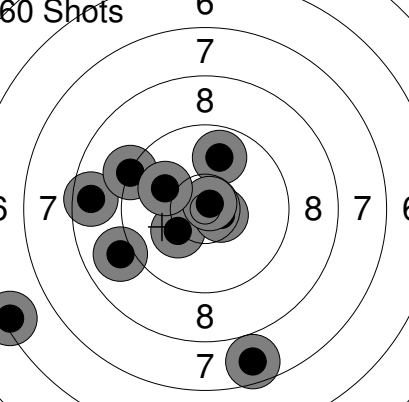
 <p>Sight 1</p>	<p>1: 9.5 ↓ 2: 9.6 ↗ 3: 7.2 ↓ 4: 9.7 ↓ 5: 8.5 ↗ 6: 9.5 → 7: 7.7 ↗ 8: 9.5 ← 9: 9.3 ↑ 10: 8.4 →</p> <p>Series 84 (0x) 0 (0x)</p>	 <p>Sight 2</p>	<p>11: 9.9 ← 12: 8.0 ← 13: 10.0 ↗ 14: 7.9 → 15: 8.6 ↓ 16: 9.8 ↑</p> <p>Series 51 (0x) 0 (0x)</p>
 <p>60 Shots 1</p>	<p>1: 7.7 ↗ 2: 8.8 ↓ 3: 8.5 → 4: 9.8 → 5: 9.3 → 6: 10.2 ↗ 7: 7.8 ← 8: 9.3 ← 9: 9.0 ↑ 10: 9.7 ↗</p> <p>Series 85 (0x) 85 (0x)</p>	 <p>60 Shots 2</p>	<p>11: 8.9 → 12: 7.9 ↗ 13: 9.8 ↗ 14: 8.6 ↗ 15: 9.5 ← 16: 1.1 ↑ 17: 6.8 ← 18: 8.9 ↗ 19: 10.4x ← 20: 8.4 ↑</p> <p>Series 74 (1x) 159 (1x)</p>
 <p>60 Shots 3</p>	<p>21: 9.5 ↓ 22: 9.3 → 23: 8.8 → 24: 9.3 ↓ 25: 9.4 ↗ 26: 8.6 ← 27: 9.3 ↑ 28: 8.1 ← 29: 8.8 ↑ 30: 7.8 ←</p> <p>Series 84 (0x) 243 (1x)</p>	 <p>60 Shots 4</p>	<p>31: 7.3 ↑ 32: 8.8 ↑ 33: 8.0 ↑ 34: 9.6 → 35: 7.8 ← 36: 9.6 ← 37: 9.7 ↑ 38: 9.4 ← 39: 7.6 ↓ 40: 8.3 ←</p> <p>Series 81 (0x) 324 (1x)</p>
 <p>60 Shots 5</p>	<p>41: 8.6 ← 42: 8.9 ← 43: 9.1 ↗ 44: 9.6 ← 45: 8.9 ← 46: 9.8 ↗ 47: 8.5 ← 48: 6.8 ↗ 49: 5.6 ↗ 50: 8.1 ←</p> <p>Series 78 (0x) 402 (1x)</p>	 <p>60 Shots 6</p>	<p>51: 9.9 ↑ 52: 9.0 ← 53: 10.2 ↓ 54: 10.6x → 55: 10.8x ↗ 56: 7.7 ↓ 57: 8.6 ← 58: 6.4 ← 59: 9.2 ← 60: 10.0 ←</p> <p>Series 88 (2x) 490 (3x)</p>

Comment	Signature
---------	-----------

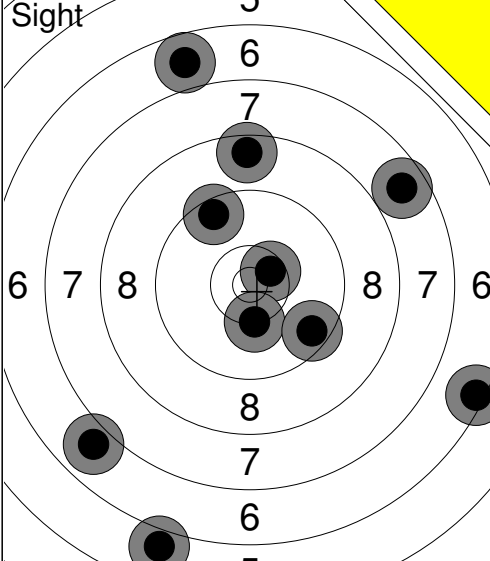
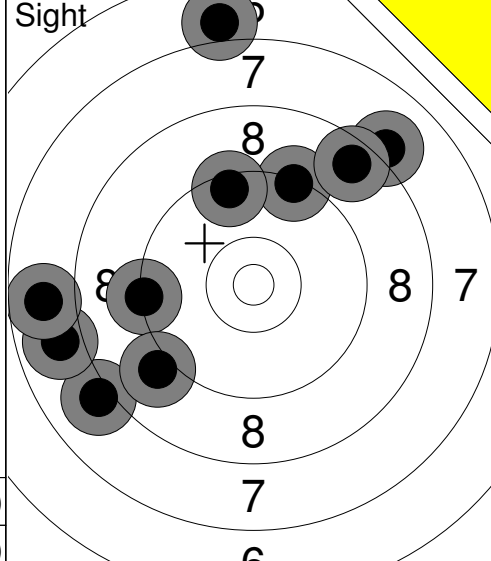
 <p>Sight</p>	<p>1: 9.5 ↗ 2: 6.9 ↙ 3: 6.4 ➡ 4: 7.7 ↘ 5: 6.8 ↑ 6: 10.5x ↘ 7: 10.3 ↓ 8: 8.6 ↑ 9: 9.5 ➡ 10: 5.9 ↓</p> <p>Series 76 (1x) 0 (0x)</p>	 <p>Sight</p>	<p>11: 9.3 ← 12: 9.3 ↑ 13: 6.9 ↑ 14: 8.0 ↙ 15: 7.9 ← 16: 8.1 ↘ 17: 9.0 ↙ 18: 9.4 ↑ 19: 7.8 ← 20: 8.6 ↗</p> <p>Series 80 (0x) 0 (0x)</p>
---	---	---	---

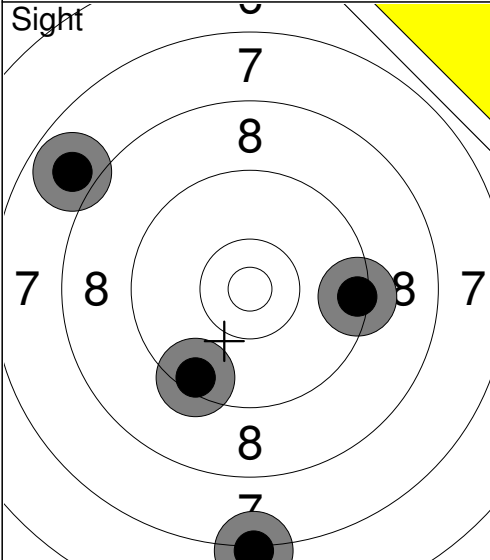
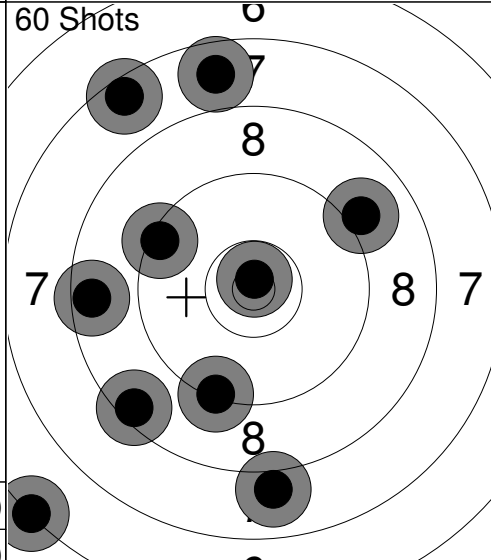
 <p>Sight</p>	<p>21: 9.4 ➡ 22: 7.2 ↓ 23: 7.9 ↖ 24: 9.4 ↙</p> <p>Series 32 (0x) 0 (0x)</p>	 <p>60 Shots</p>	<p>1: 9.4 ↖ 2: 8.5 ← 3: 7.7 ↑ 4: 8.4 ↙ 5: 7.5 ↖ 6: 10.8x ↑ 7: 9.0 ↘ 8: 6.3 ↙ 9: 9.3 ↓ 10: 8.0 ↓</p> <p>Series 81 (1x) 81 (1x)</p>
--	---	---	---

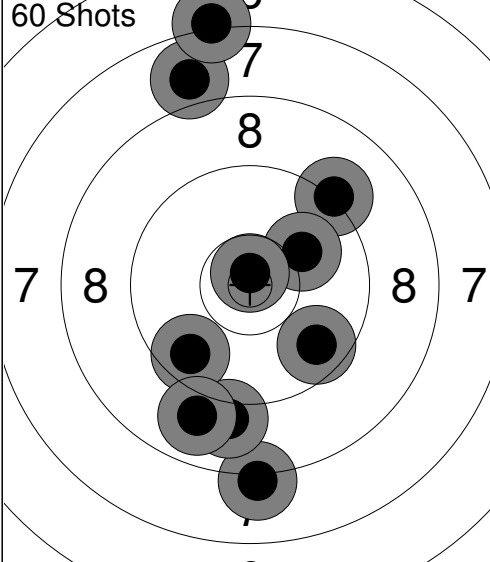
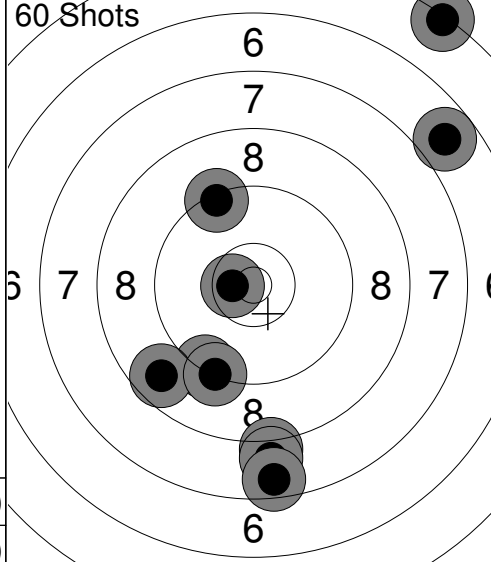
 <p>60 Shots</p>	<p>11: 7.9 ↑ 12: 9.7 ➡ 13: 7.2 ↑ 14: 8.1 ↓ 15: 9.2 ↗ 16: 10.1 ↘ 17: 9.0 ↓ 18: 10.8x ↑ 19: 9.6 ↙ 20: 8.9 ↓</p> <p>Series 86 (1x) 167 (2x)</p>	 <p>60 Shots</p>	<p>21: 9.3 ↑ 22: 10.6x ← 23: 9.3 ↙ 24: 8.7 ↙ 25: 9.3 ↙ 26: 8.1 ↓ 27: 7.9 ↓ 28: 5.3 ↗ 29: 6.8 ↘ 30: 7.6 ↓</p> <p>Series 78 (1x) 245 (3x)</p>
--	--	--	---

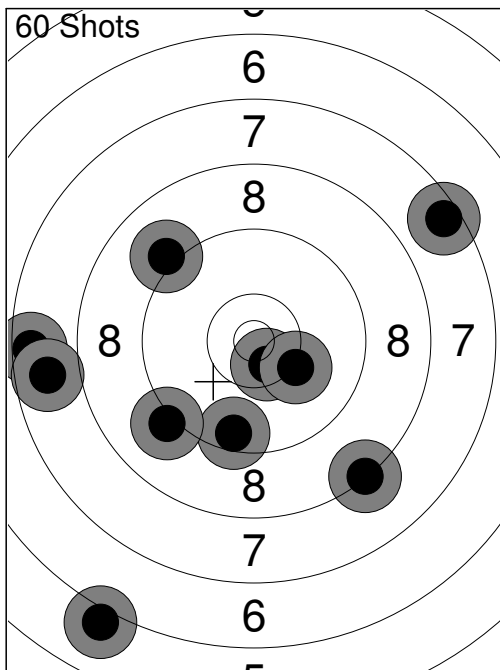

31:	7.5	←
32:	7.5	↗
33:	9.5	↓
34:	8.3	↘
35:	10.5x	↘
36:	7.7	←
37:	9.1	↙
38:	6.0	↘
39:	9.1	↗
40:	10.2	↘
Series	82 (1x)	
	327 (4x)	

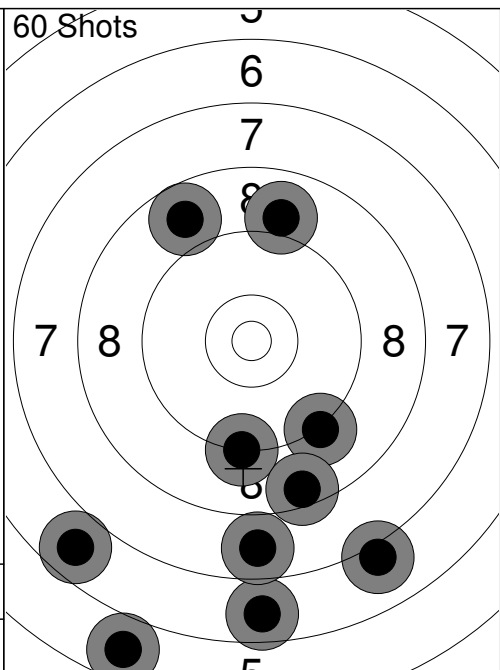

41:	5.7	↘
42:	9.0	↑
43:	8.8	↖
44:	9.2	↘
45:	6.7	↘
46:	9.2	↘
47:	7.7	↓
48:	6.7	↙
49:	7.0	↘
50:	8.5	↘
Series	74 (0x)	
	401 (4x)	

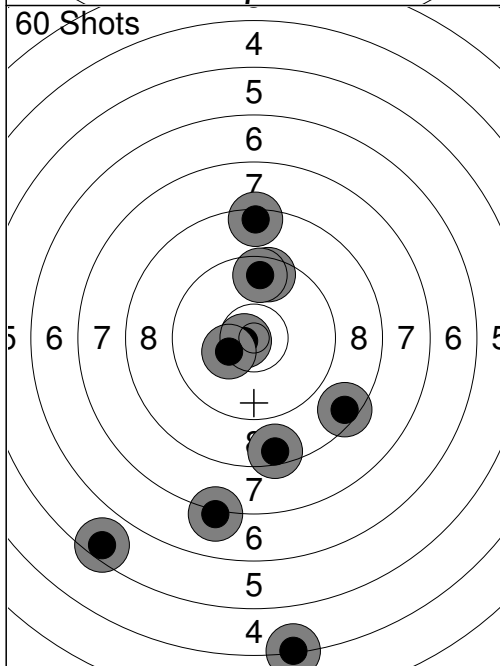

51:	9.6	↑
52:	9.6	↑
53:	5.5	↘
54:	10.7x	←
55:	8.5	↘
56:	4.3	↓
57:	8.4	↑
58:	10.3	↙
59:	8.5	↘
60:	7.1	↓
Series	78 (1x)	
	479 (5x)	

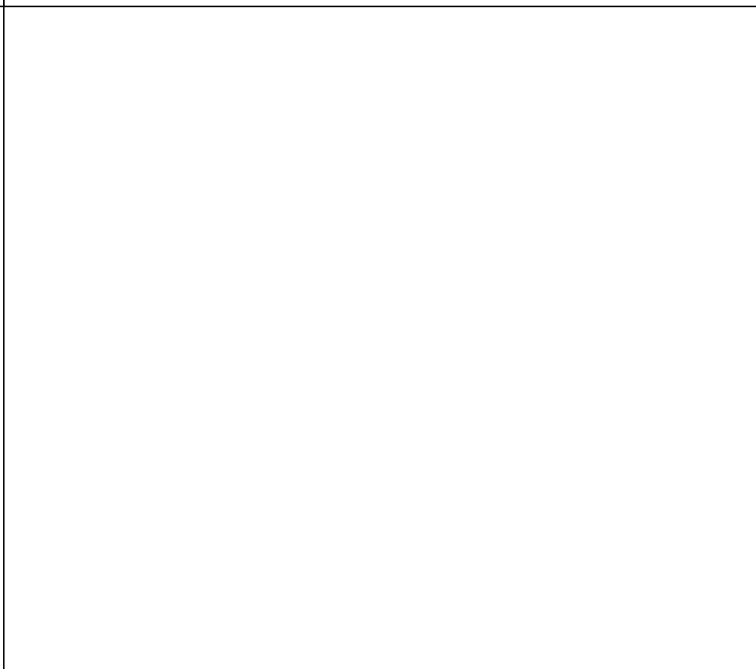
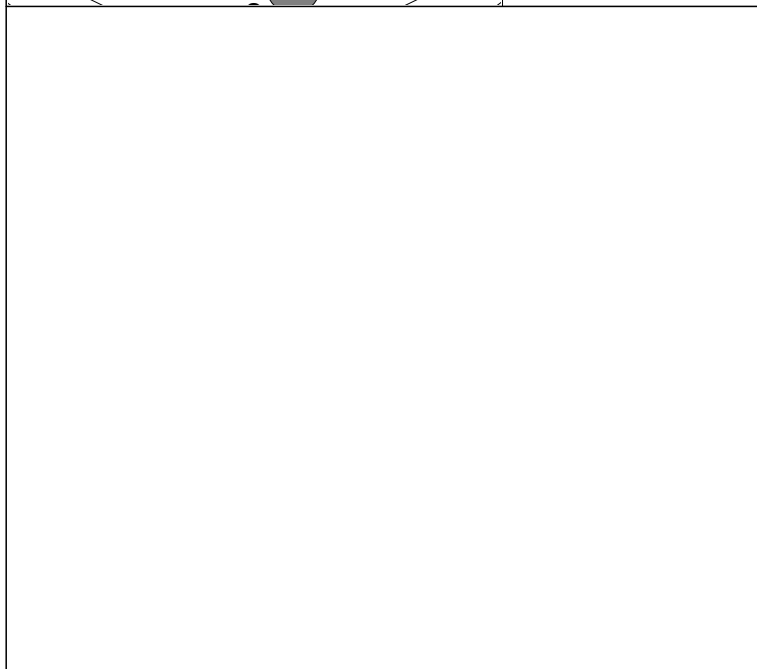

Comment	Signature		
---------	-----------	--	--

<p>Sight</p>	<p>1: 10.3 ↓ 2: 10.1 ↗ 3: 9.9 ↗ 4: 7.9 ← 5: 8.1 ↗ 6: 8.8 ↓ 7: 10.1 → 8: 8.8 ↑ 9: 6.2 ↓ 10: 7.7 ↓</p> <p>Series 83 (0x) 0 (0x)</p>	<p>Sight</p>	<p>11: 5.6 ↗ 12: 6.3 ↗ 13: 7.4 ↗ 14: 9.6 → 15: 8.6 ↑ 16: 9.9 ↗ 17: 6.8 ↗ 18: 9.8 ← 19: 6.6 ↑ 20: 6.1 ↗</p> <p>Series 71 (0x) 0 (0x)</p>
--------------	---	--------------	---

<p>Sight</p>	<p>21: 8.9 ↓ 22: 6.5 ↗ 23: 9.2 ← 24: 9.9 ← 25: 9.8 ← 26: 8.0 ↑ 27: 8.3 ↓</p> <p>Series 57 (0x) 0 (0x)</p>	<p>Shots</p>	<p>1: 10.3 ← 2: 8.5 ↑ 3: 8.2 ↑ 4: 10.8x ↓ 5: 9.7 ← 6: 8.8 ↓ 7: 10.1 ↓ 8: 9.8 ← 9: 7.1 ↗ 10: 8.7 ←</p> <p>Series 87 (1x) 87 (1x)</p>
--------------	---	--------------	---

<p>60 Shots</p>	<p>11: 9.2 ↓ 12: 9.7 ↓ 13: 9.1 ↗ 14: 9.1 ↗ 15: 10.2 ↓ 16: 9.5 → 17: 9.1 ↓ 18: 8.8 ↑ 19: 10.7x ↓ 20: 9.1 ←</p> <p>Series 91 (1x) 178 (2x)</p>	<p>60 Shots</p>	<p>21: 8.9 ← 22: 10.0 ↗ 23: 6.5 ↗ 24: 9.4 ↓ 25: 8.9 ↑ 26: 8.7 ← 27: 8.3 ↓ 28: 9.4 → 29: 10.1 ↗ 30: 7.2 ←</p> <p>Series 83 (0x) 261 (2x)</p>
-----------------	--	-----------------	---

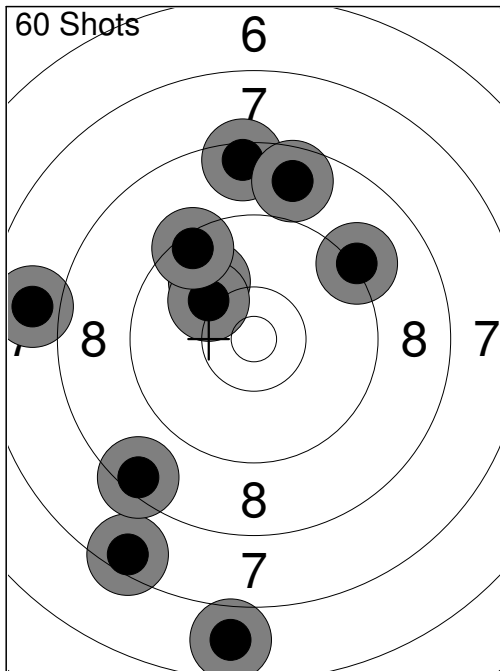

31:	9.9	↖
32:	8.5	↑
33:	6.8	↓
34:	8.7	↑
35:	7.5	↘
36:	8.5	↘
37:	9.2	↗
38:	10.1	↖
39:	7.9	←
40:	9.4	↖

Series	81 (0x)
	342 (2x)

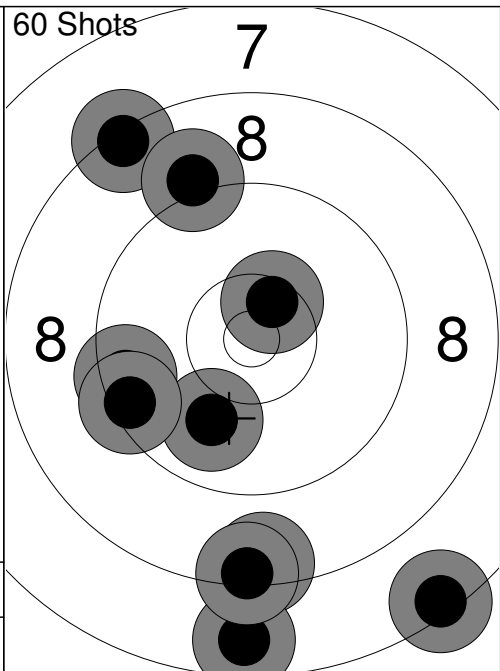

41:	7.4	↘
42:	10.0	↘
43:	10.5x	↗
44:	8.5	↓
45:	7.6	↓
46:	9.5	←
47:	9.4	←
48:	8.3	↖
49:	8.4	↓
50:	9.1	↖

Series	85 (1x)
	427 (3x)

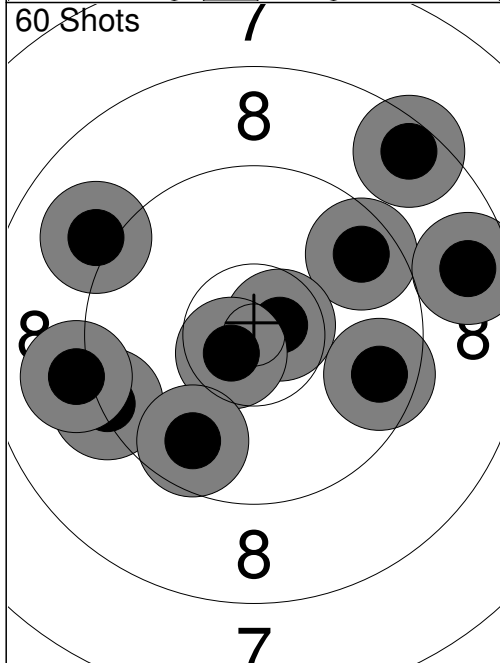

51:	9.6	↗
52:	10.7x	→
53:	10.7x	↙
54:	9.3	←
55:	8.7	→
56:	9.6	→
57:	8.5	↗
58:	9.1	←
59:	9.7	↘
60:	9.1	↖

Series	90 (2x)
	517 (5x)

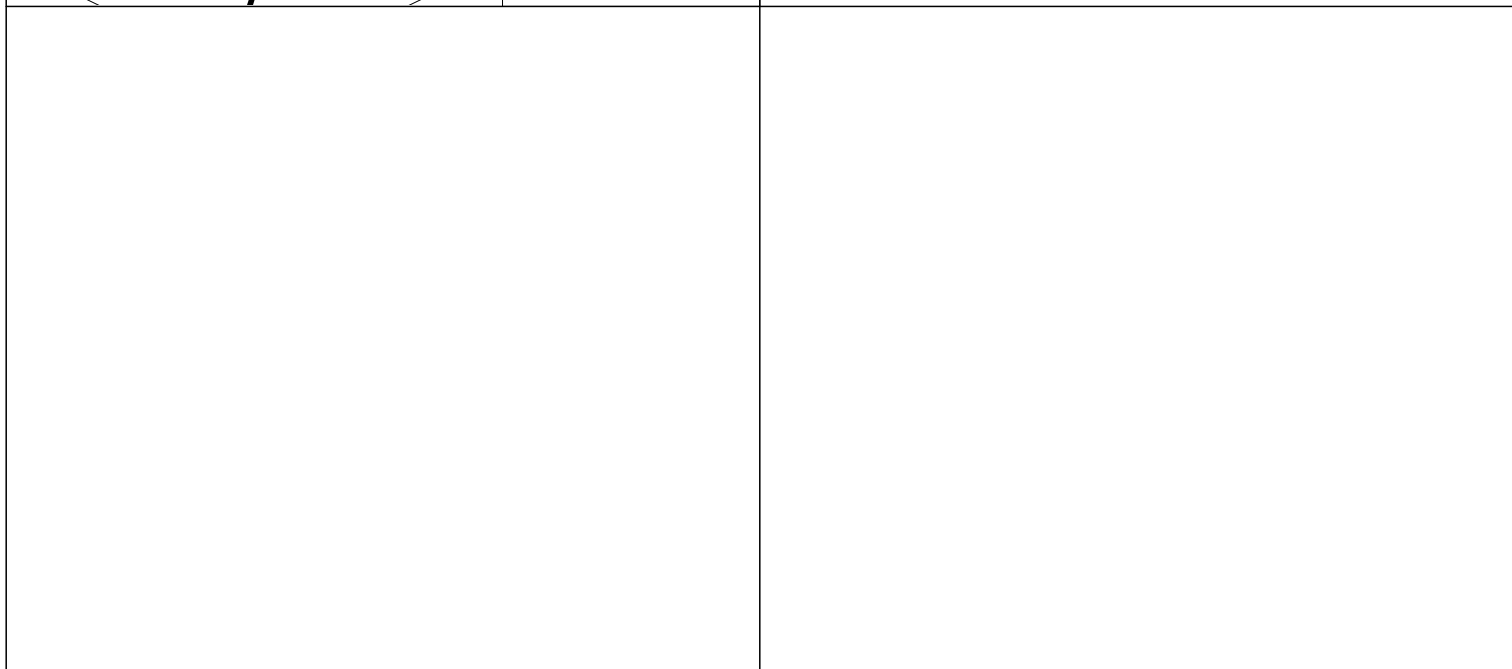

<p>Sight</p>	<p>1: 9.0 ↙ 2: 9.8 ↓ 3: 9.2 ↙ 4: 10.0 ↖ 5: 9.9 ↓ 6: 5.7 ↓ 7: 10.0 → 8: 9.0 ↑ 9: 8.6 ↓ 10: 8.4 ↓</p> <p>Series 86 (0x) 0 (0x)</p>	<p>Sight</p>	<p>11: 9.6 ↓ 12: 8.1 ↓ 13: 10.3 ↗ 14: 9.7 → 15: 9.8 →</p> <p>Series 45 (0x) 0 (0x)</p>
<p>60 Shots</p>	<p>1: 10.3 → 2: 7.4 ↓ 3: 8.9 ↖ 4: 8.6 ↓ 5: 10.5x ↓ 6: 9.9 → 7: 9.9 → 8: 9.8 → 9: 10.1 ↓ 10: 9.2 ↑</p> <p>Series 89 (1x) 89 (1x)</p>	<p>60 Shots</p>	<p>11: 9.2 → 12: 9.4 ↓ 13: 10.0 ↗ 14: 10.2 ↖ 15: 9.0 ↓ 16: 10.2 ↑ 17: 10.1 ↑ 18: 9.7 ↖ 19: 9.9 ↖ 20: 10.1 ↓</p> <p>Series 95 (0x) 184 (1x)</p>
<p>60 Shots</p>	<p>21: 10.7x → 22: 9.6 ↗ 23: 9.3 ↖ 24: 9.2 → 25: 8.8 ↓ 26: 10.3 ↖ 27: 9.3 → 28: 9.6 ↗ 29: 9.5 → 30: 10.7x ↑</p> <p>Series 92 (2x) 276 (3x)</p>	<p>60 Shots</p>	<p>31: 9.6 ↗ 32: 8.6 ↗ 33: 9.3 ↗ 34: 9.7 ↖ 35: 10.6x ↓ 36: 10.7x ↓ 37: 9.9 ↑ 38: 10.2 ↖ 39: 9.2 ↓ 40: 9.8 ↗</p> <p>Series 92 (2x) 368 (5x)</p>
<p>60 Shots</p>	<p>41: 9.9 ↑ 42: 10.2 → 43: 9.9 ↗ 44: 10.3 ↖ 45: 10.6x ↖ 46: 10.1 → 47: 10.7x ↖ 48: 10.6x ↖ 49: 9.5 ↓ 50: 10.1 ↗</p> <p>Series 97 (3x) 465 (8x)</p>	<p>60 Shots</p>	<p>51: 9.7 ↓ 52: 10.0 → 53: 9.5 ↖ 54: 9.9 → 55: 9.3 → 56: 8.9 ↖ 57: 7.9 ↓ 58: 10.4x ↖ 59: 8.4 ↓ 60: 6.3 ↖</p> <p>Series 85 (1x) 550 (9x)</p>

Relay 2	Lane 28	DU Max
-------------------	-------------------	---------------

2023 SFC Pistol Nationals	AB	JR	MP
---------------------------	----	----	----

15.07.2023	PN23AP-Q-1	Alberta Handgun Association
------------	------------	-----------------------------

Comment	Signature
---------	-----------

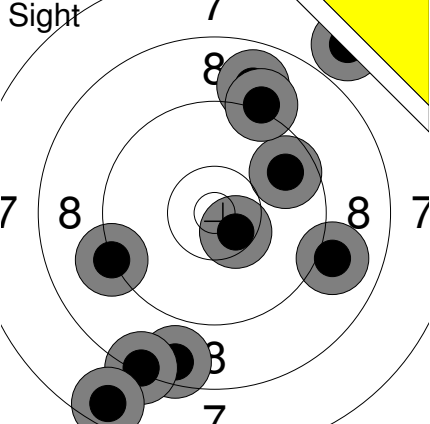
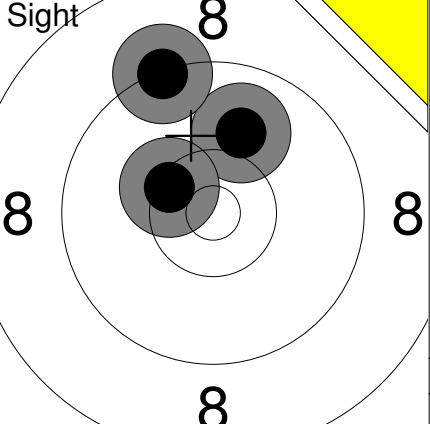
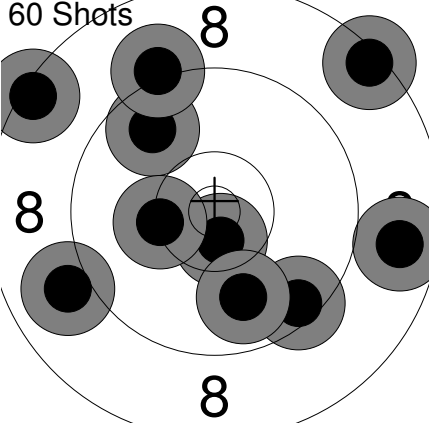
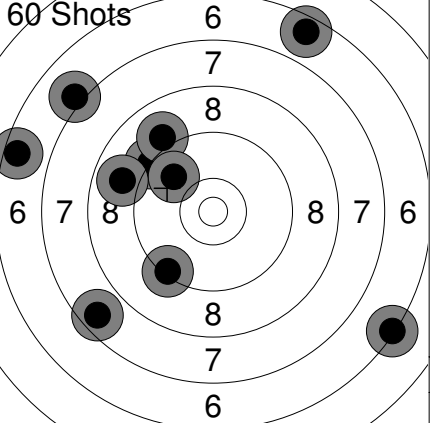
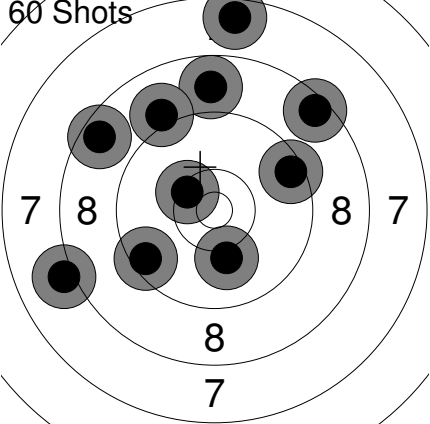
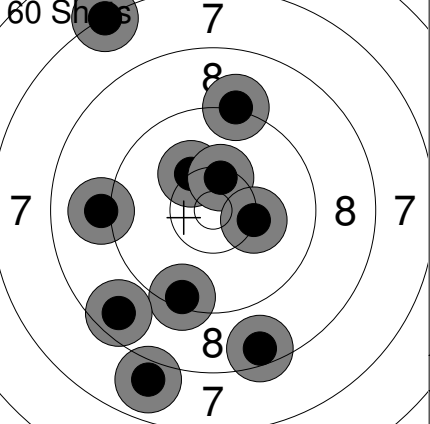
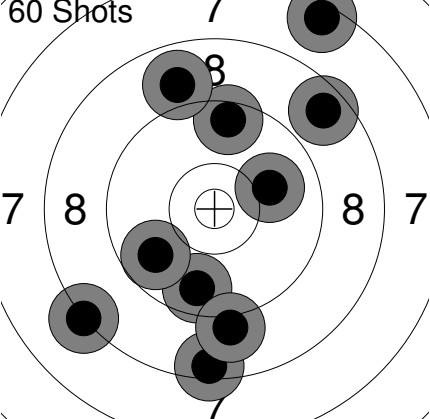
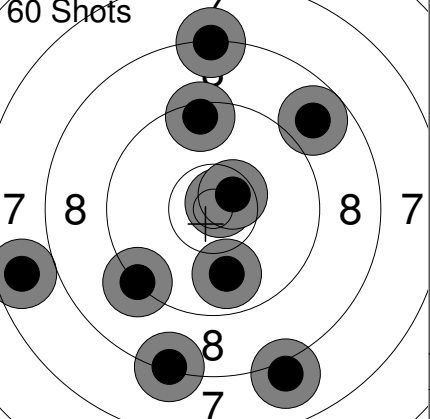
Sight 	1: 10.5x ↘ 2: 8.9 ↑ 3: 9.7 → 4: 8.6 ↓ 5: 9.2 ← 6: 8.3 ↓ 7: 7.6 ↓ 8: 9.1 ↑ 9: 7.6 ↗ 10: 9.0 →	Sight 	11: 10.0 ↑ 12: 10.4x ↖ 13: 9.3 ↑
	Series 84 (1x) 0 (0x)		Series 29 (1x) 0 (0x)
60 Shots 	1: 10.6x ↓ 2: 8.7 → 3: 9.7 ↗ 4: 8.4 ↗ 5: 10.3 ← 6: 9.5 ↓ 7: 9.1 ↗ 8: 9.0 ← 9: 9.9 ↓ 10: 8.4 ↗	60 Shots 	11: 6.6 ↑ 12: 9.2 ↗ 13: 7.1 ↗ 14: 7.6 ↘ 15: 9.3 ↘ 16: 9.0 ↗ 17: 9.8 ↗ 18: 6.3 ↘ 19: 8.9 ↖ 20: 6.5 ↖
	Series 89 (1x) 89 (1x)		Series 76 (0x) 165 (1x)
60 Shots 	21: 7.6 ↑ 22: 8.8 ↑ 23: 8.1 ← 24: 8.6 ↖ 25: 9.5 ← 26: 8.5 ↗ 27: 10.1 ↓ 28: 9.5 → 29: 10.4x ↖ 30: 9.0 ↗	60 Shots 	31: 10.2 ↖ 32: 7.9 ↓ 33: 9.4 ↓ 34: 9.2 ↑ 35: 10.4x ↑ 36: 8.6 ↘ 37: 8.5 ↓ 38: 9.1 ← 39: 7.3 ↗ 40: 10.3 →
	Series 86 (1x) 251 (2x)		Series 87 (1x) 338 (3x)
60 Shots 	41: 8.4 ↓ 42: 7.4 ↗ 43: 9.5 ↑ 44: 8.6 ↗ 45: 9.7 ↓ 46: 8.2 ↖ 47: 9.8 ↖ 48: 10.0 → 49: 9.0 ↓ 50: 8.9 ↑	60 Shots 	51: 10.8x ↗ 52: 8.0 ↓ 53: 10.6x ↗ 54: 9.9 ↓ 55: 8.3 ↓ 56: 7.7 ← 57: 9.4 ↑ 58: 8.8 ↗ 59: 8.3 ↑ 60: 9.2 ↘
	Series 85 (0x) 423 (3x)		Series 86 (2x) 509 (5x)

Relay **2** Lane **29** **FU Daniel yuhui**

2023 SFC Pistol Nationals BC IJ MP

15.07.2023 PN23AP-Q-1 Alberta Handgun Association

Comment Signature

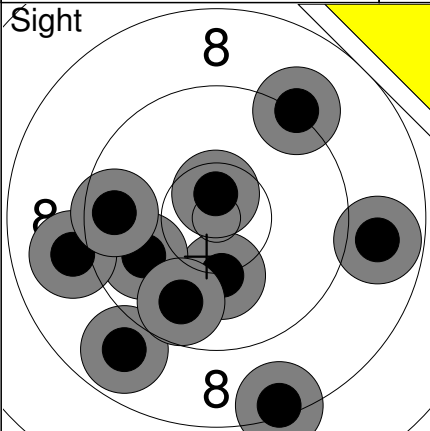
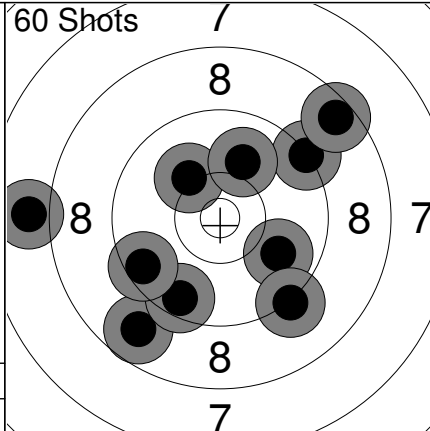
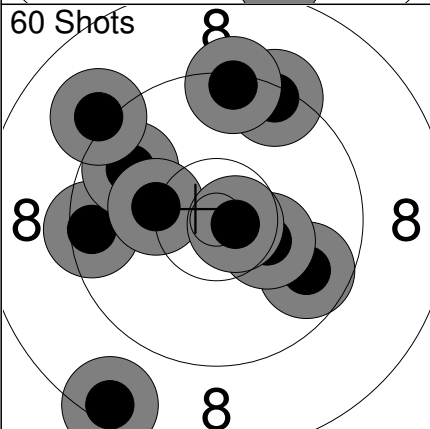
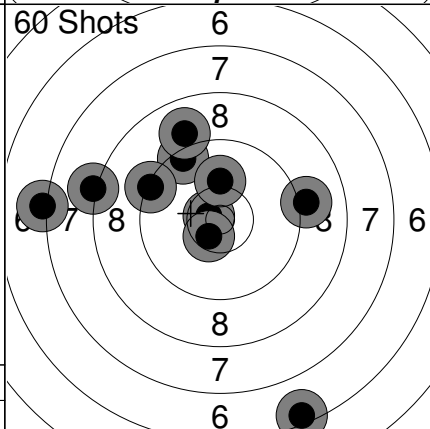
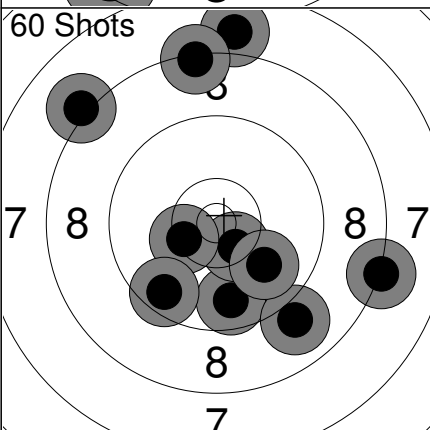
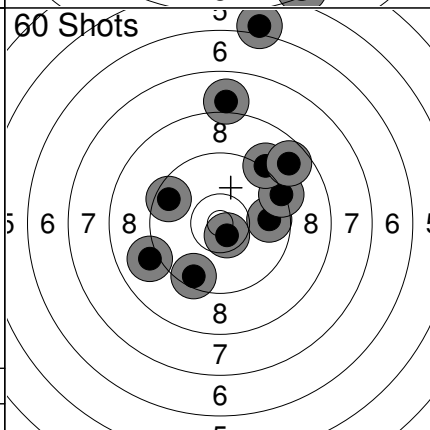
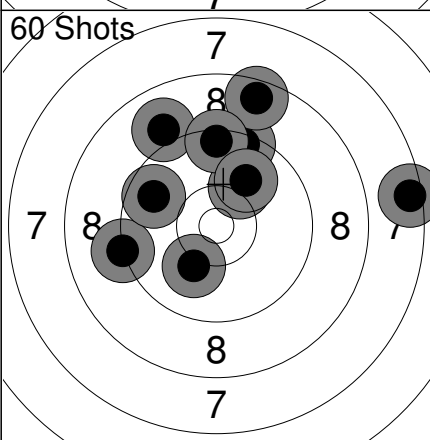
<p>Sight</p> 	<p>1: 8.8 → 2: 10.2 ↓ 3: 9.9 ← 4: 9.2 ↗ 5: 9.0 ← 6: 8.4 ↓ 7: 9.6 ← 8: 8.9 ↓ 9: 10.6x ↑ 10: 9.8 ↓</p> <p>Series 89 (1x) 0 (0x)</p>	<p>60 Shots 7</p> 	<p>1: 9.3 ↗ 2: 9.9 ↘ 3: 7.9 ← 4: 9.2 ↘ 5: 10.1 ↗ 6: 8.5 ↗ 7: 10.0 ↑ 8: 8.8 ↓ 9: 9.5 ↓ 10: 9.5 ↙</p> <p>Series 88 (0x) 88 (0x)</p>
<p>60 Shots</p> 	<p>11: 9.7 → 12: 8.5 ↓ 13: 9.5 ← 14: 10.3 → 15: 9.4 ↗ 16: 9.8 ↗ 17: 10.2 ← 18: 9.4 ↑ 19: 9.1 ↗ 20: 10.7x →</p> <p>Series 92 (1x) 180 (1x)</p>	<p>60 Shots 6</p> 	<p>21: 10.7x ← 22: 6.4 ↓ 23: 8.2 ← 24: 9.1 → 25: 9.4 ↗ 26: 9.0 ↑ 27: 7.1 ← 28: 10.5x ↓ 29: 9.3 ← 30: 10.1 ↑</p> <p>Series 87 (2x) 267 (3x)</p>
<p>60 Shots</p> 	<p>31: 9.7 ↓ 32: 8.2 → 33: 10.5x ↓ 34: 10.4x ← 35: 8.1 ↗ 36: 7.9 ↑ 37: 9.6 ↓ 38: 9.0 ↓ 39: 9.9 ↓ 40: 8.3 ↑</p> <p>Series 87 (2x) 354 (5x)</p>	<p>60 Shots 5</p> 	<p>41: 10.6x ↓ 42: 9.7 → 43: 9.0 ← 44: 9.5 ↓ 45: 9.3 → 46: 9.6 ↙ 47: 8.0 ↑ 48: 6.0 ↑ 49: 9.1 ↗ 50: 8.7 ↗</p> <p>Series 86 (1x) 440 (6x)</p>
<p>60 Shots</p> 	<p>51: 10.1 ↓ 52: 9.4 ↑ 53: 8.6 ↑ 54: 10.1 ↗ 55: 9.0 ↗ 56: 9.2 ← 57: 9.4 ↑ 58: 9.7 ← 59: 10.0 ↗ 60: 7.4 →</p> <p>Series 90 (0x) 530 (6x)</p>		